

HALOGEN FREE KABLO KANALI
KENDİNDEN KAPAKLI KANALLAR
DIŞTAN KAPAKLI KANALLAR
MEKS 100'LÜK SERİ PRİZ MONTAJ SETLERİ
MEKSPLUS SERİSİ İÇTEN KAPAKLI KANALLAR
SÜPÜRGELİK KABLO KANALLARI
ZEMİN KABLO KANALLARI
PROFİLLER
KLİMA KANALI
SİDEM SERİSİ KABLO KANALLAR
HALOGEN FREE DELİKLİ KABLO KANALI
DELİKLİ KABLO KANALI

HALOGEN FREE CABLE TRUNKING
CABLE TRUNKING WITH INTRINSIC COVER
CABLE TRUNKING WITH EXTERNAL COVER
MEKS 100 SERIES PLUG SOCKET ASSEMBLY SETS
MEKSPLUS SERIES WITH INTRINSIC COVER TRUNKING
SKIRTING BOARD CABLE TRUNKING
FLOOR CABLE TRUNKING
PROFILES
AIR CONDITIONING TRUNKING
SIDEM SERIES CABLE TRUNKING
HALOGEN FREE PERFORATED CABLE TRUNKING
PERFORATED CABLE TRUNKING

SAYFA
PAGE

04
62

SANAYİ FİŞ - PRİZ GRUBU
SİNYAL VE KUMANDA BUTONLARI
ETANJ BUTON KUTULARI
VİNÇ KUMANDA BUTONLARI
SÜPER ETANJ RAKORLAR
RAY KLEMENSLER
SIKMALI TİP KABLO PAPUÇLARI
SİRA KLEMENSLER
RAYLAR, TOPRAKLAMA ÇUBUĞU VE BARALAR
DÖNER LAMBA, FLAŞÖRLÜ LAMBA VE SİRENLER
İKAZ LAMBALARI
TERMOPLASTİK BUATLAR

PLUG - SOCKET GROUP
SIGNAL AND CONTROL BUTTONS
WATERPROOF BUTTON BOXES
CRANE CONTROL BUTTONS
SUPER WATERPROOF CABLE GLANDS
RAIL TERMINAL BLOCKS
CLAMPING TYPE CABLE TERMINAL LUGS
WIRE CONNECTORS
RAILS, GROUNDING ROD AND BUSBARS
ROTATING BEACON, BLINKER BEACON AND SIRENS
WARNING LIGHTS
THERMOPLASTIC JUNCTION BOXES

SAYFA
PAGE

63
98

W OTOMAT KUTULARI
TELEFON DAĞITIM KUTULARI VE AKSESUARLARI
MODÜL BAĞLANTI ÇATISI
ÇELİK SİRALLER PVC SİRALLER VE BORULAR
HALOGEN FREE SİRALLER
SİBOR SERİSİ BORULAR
SUSTALAR VE BUAT KAPAKLARI
BETON DUVAR KASALARI
PLASTİK KASA VE BUATLAR
KROŞELER
PLASTİK DÜBELLER

FUSE BOXES
TELEPHONE DISTRIBUTION BOXES (HUBS) and ACCESSORIES
MODULE CONNECTION RACK
STEEL SPIRALS PVC SPIRALS AND PIPES
HALOGEN-FREE SPIRALS
SİBOR SERIES PIPES
CABLE PULLERS AND JUNCTION BOX COVERS
CONCRETE WALL CASINGS
PLASTIC CASINGS AND JUNCTION BOXES
CABLE STRAPS
PLASTIC DOWELS

SAYFA
PAGE

99
128

LED AYDINLATMA ARMATÜRLERİ
PARABOLİK TAVAN ARMATÜRLERİ
YÜKSEK TAVAN AYDINLATMA ARMATÜRLERİ
BANT TİPİ ARMATÜRLER
TAVAN ARMATÜRLERİ
ACİL DURUM ARMATÜRLERİ

LED LIGHTING LUMINARIES
PARABOLIC CEILING LIGHTING LUMINARIES
HIGH CEILING LIGHTING LUMINAIRE
BATTEN TYPE LUMINAIRE
CEILING LIGHTING FIXTURE
EMERGENCY LIGHTING

SAYFA
PAGE

129
161

Değerli Dostlarımız,



1983 yılında kurulan Mutlusan, kalite ve dürüstlük ilkelerinden sapmadan, dünya standartlarında hizmet vermeyi kendine ilke edinmiş, müşteri odaklı çözümler sunmaya yönelik çalışmaları ve alanında uzman ve eğitimli personeli ile bu günlere kadar başarıyla gelmiştir.

Ürün gamı içinde kablo kanal ve aksesuarları, w otomat kutuları, PVC yanmaz spiraller, halojen free spiraller, polietilen borular, çelik ve izoleli çelik spiraller, sinyal armatürleri ve aydınlatma armatürleri yer almaktadır. Üretimimin %60'ını 60 farklı ülkeye ihraç ederek ülkemiz ekonomisine katkıda bulunmanın haklı gururunu yaşayan firmamız yurt içindeki saygın müşterilerine de 5000'i aşkın yetkili satıcısı ve İstanbul'da ki 3 ana mağazasıyla ulaşmaktadır. Kurulduğu günden bu yana "Kalite, müşterinin beklenti ve isteklerini karşılamak bizim yeteneğimizdir" tanımını kurum felsefesi olarak benimseyen firmamız TSE ve TSEK, ISO 9001 - 2008 belgelerini alarak uluslararası kalite standartlarını uygulamaya dönük çalışmalarını tamamlamış olup VDE, RoHS, CE, Rusya Federasyonu Yanmazlık Belgesi, Ukrayna Kalite Belgesi ve Rusya Federasyonu Kalite Standard belgelerine sahiptir.

Köklü ve parlak geçmişi ile tüketici nezdinde ki marka bilinirliği her geçen gün artmakta olan firmamız, sizlerin sayesinde hızla büyüyerek yeni hedeflere doğru yol almaktadır. Taleplerinizi karşılamak için, üretim kapasitesini %100 arttıracak olan toplam 20.000 metrekarelik kapalı alanlı yeni üretim tesisi ve teknolojik altyapı yatırımlarını tamamlamış olmanın verdiği güvenin sevincini yaşamaktadır.

Vizyonumuz:

Dünya kalitesinde elektrik malzemeleri üreten, ürettiren ve pazarlayan; bölgesinde lider, güçlü bir Türkiye markası olmak.

Misyonumuz:

Türkiye'nin değişen dinamikleri doğrultusunda, koşulsuz müşteri memnuniyetini ön planda tutarak ve kaliteyi bir yaşam biçimi haline getirerek liderliğini koruyan rekabetçi konumu ile küresel ölçekte ilk tercih edilen marka olmak. Sektöre yeni uygulama alanları ve yaratıcı çözümler getirerek alışılmışın dışında bir çizgide, kalite ve dürüstlük ilkelerinden ödün vermeden talebi karşılamaktır.

Mustafa KAÇMAZ

Yönetim Kurulu Başkanı
Chairman of the Executive Board / CEO

Dear Friends,

Incorporated in 1983, Mutlusan adopted offering services conforming to worldwide recognized standards without deviating from the principles of quality and honesty as a principle and managed to carry on its business until this day by virtue of its studies intended for providing customer-oriented solutions and its expert and educated staff.

The product range includes cable conduits and accessories, fuse boxes, PVC nonflammable spirals, halogen-free spirals, polyethylene pipes, steel and insulated steel spirals, signalization fittings and lighting fixtures. Experiencing the proper pride of contributing to our country's economy by exporting almost 60% of our manufacture to 60 different countries, our firm also serves to our end users through more than 5000 local business partners around the country and 3 main sales shops located in Istanbul. Adopting the definition "Quality and meeting the expectations and requests of our customers is our inherent talent" as the corporate philosophy since the very first day of its incorporation, our firm has been awarded with TSE and TSEK ISO 9001-2008 certifications, thus completing the studies for implementation of international quality standards and further holds VDE, RoHS, CE, Russian Federation certificate of non-combustibility, Ukraine Certificate of Quality and Russian Federation Quality Standard certification.

"With brand awareness before the consumers raising every day, our firm moves towards new objectives through rapid growth by virtue of its long-established and brilliant history." We are experiencing the gratification of the confidence as provided by completion of technological infrastructure investments and a new production plant with 20.000 square meters of indoor space, which shall improve our production capacity by 100% in order to meet your demands.

Our vision;

Being recognized as a strong Turkish brand with standard bearer position in its territory and that produces, procures production of and markets electrical equipment manufactured to the world standard.

Our Mission;

Being recognized as a preferred brand at global scale by virtue of the competitive position maintaining its leadership by prioritizing unconditional customer satisfaction and by adopting quality as a lifestyle in accordance with the ever-changing dynamics of Turkey. Meeting the demand by imposing new fields of applications and creative solutions for the sector without conceding from quality and honesty principles by following an extraordinary pattern.



KABLO KANALLARI

CABLE TRUNKING





KABLO KANALLARI
CABLE TRUNKING



RENKLİ KABLO KANALLARI
COLORED CABLE TRUNKING

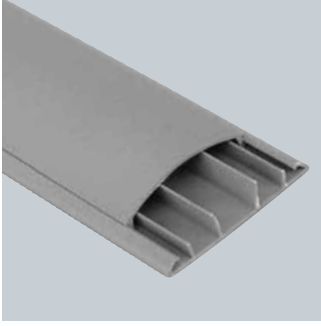

ZEMİN KABLO KANALLARI
FLOOR CABLE TRUNKING



DELİKLİ KABLO KANALLARI
SLOTED CABLE TRUNKING

Neden Mutlusan Kablo Kanallarını Kullanmalıyız



1 Ürünlerimiz hafif ve dayanıklıdır,
Our products are light-weighted and durable,

2 Zengin renk ve desenleriyle yapılarınızın dekorasyonu ile estetik bir uyum içerisinde oluşur,
Our products are in aesthetic harmony with the decoration of your buildings by virtue of rich color and pattern options,

3 İstenilen ölçülerde kesilebilir ve istenen renkte boyanabilir olma özelliği,
Our products can be tailor-cut to the desired dimensions and can be painted to desired color,

4 Kablo kanallarındaki geçmeli sistemin montaj kolaylığı sağlar,
Ease of assembly through click-fit system at cable trunking,

5 Pano içi delikli kablo kanallarının endüstriyel uygulamalardaki esnek kablo döşemelerinde kullanılabilir
Perforated cable trunking can be used at flexible cable installations for industrial practices,

6 Ürünlerimizin büyük çoğunluğunun aynı ebatlarda aksesuarları mevcuttur
Availability of cable trunking accessories with identical sizes for majority of our products,

7 Elektrik kablolarının ve bilgisayar sistemlerinin düzenlenmesinde, asansör ve doğalgaz boru kapatmalarında, prefabrik yapılar ve güvenlik sistemlerinde yaygın kullanım.
Extensive usage for arrangement of electrical wiring and computer systems, elevator and natural gas piping enclosures and prefabricated structures and security systems.



8 Mükemmel kalıp tasarımı sayesinde üstün yüzey düzgünlüğü,
Superior surface smoothness by virtue of excellent die design,

9 Tadilatlı uygulamalar duvarda sıva hatalarına neden olurken, kablo kanalları uygulaması duvarlarınızın kırılıp dökülerek deforme olmasını önler,
While modification practices cause plaster errors on your walls, cable trunking applications prevent deformation of your walls due to demolition,

10 Priz ve anahtar montajında geçmeli montaj özelliği sayesinde pratik ve kolay sabitleme özelliği, kolay montaj,
Practical and easy fixation and easy assembly by virtue of click-fit assembly feature of power outlets and switches,

11 Kanal gövdesindeki delikler sayesinde hızlı montaj olanağı, sabitleme ayakları sayesinde kolay anahtar ve priz montajı yapılabilmesi
Quick assembly by virtue of pre-drilled perforations on the trunking body and easy switch and socket assembly by virtue of fixing tool,

12 Kanal içindeki ray sistemiyle kabloların birbirinden bağımsız bir şekilde taşınabilmesi, aynı kanaldan birden fazla kablo geçirilebilir olması özelliği,
The rail system within the trunking enables installation of cables independently and multiple cables can be laid inside the same trunking,

Kablo Kanallarımızın Teknik Özellikleri

Technical Specifications For Cable Trunking

Halogen Free
Alev Yaymayan
Nonflammable!



Ultraviyole ışınlarına
karşı dayanıklıdır.
Resistance to
UV Light



Asit buharına
dayanıktır
Resistance to
acidic vapor



Elektriksel yalıtım
özellğine sahiptir
Electrically
insulated



Daha pratik ve kolay montaj
için tüm kanallarımız çift
tarafı yapışkanlı bant ile
kullanılabilir

Adhesive models
are easy to install

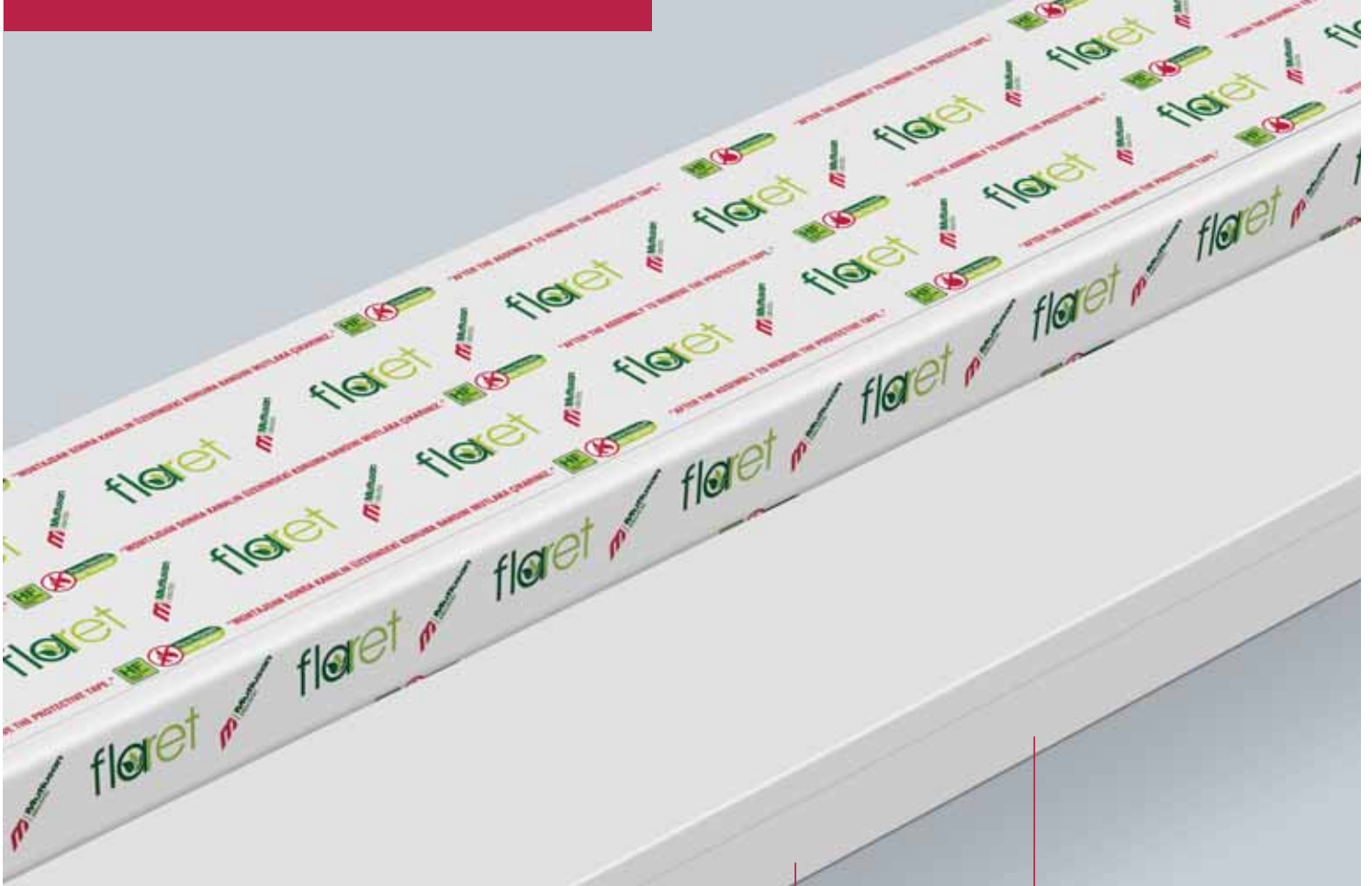

Darbelerle dayanıklıdır.

Shock Resistance



İstenilen renkte boyanabilir

Can be painted to desired color!

+60°-25°

Aşırı soğuğa ve sığağa karşı dayanıklı

Resistant to extreme cold and heat

IP4X

Katı yabancı maddelerin girişine karşı koruma

Protection against ingress of solid foreign substances



ULUSLARARASI KALİTE NORMATINA UYGUN ÜRETİM!

MUTLUSAN PLASTİK, kablo kanal kalitesini henüz üretim bandından GİRİŞ - PROSES - SON KONTROL ve yüksek teknoloji ürünü TEST CİHAZLARI ile donatılmış LABORATUVAR TESTLERİ ile garanti altına alır.

PRODUCTION COMPLYING WITH INTERNATIONAL QUALITY STANDARDS! MUTLUSAN PLASTİK assures the quality of the cable trunking through INPUT-PROCESS-FINAL CONTROL procedure and LABORATORY TESTS equipped with state-of-the-art TEST EQUIPMENT implemented at the plant when the products are still on the production line.

HALOGEN FREE KABLO KANALI HALOGEN FREE CABLE TRUNKING



flaret



Flame Retardant
Alev Yaymayan



Ürün Kodu	Product Code	001 060 04025 20 00
Ambalaj Şekli	Packing Type	Kutu - Box
Adet / m	Quantity / m	20 m
Ağırlık	Weight	17.700 kg
m ³ /	Volume	0.12022

AKSESUARLAR - ACCESSORIES

Kod Code	Ürün Product	Adet Quantity	Ağırlık Weight	m ³ Volume
001 039 040025 11 00	İç Köşe Internal Corner	24	0.354 kg	0.01044
001 040 040025 11 00	Dış Köşe External Corner	30	0.691 kg	0.00272
001 041 040025 11 00	T Köşe T Corner	18	0.345 kg	0.00731
001 042 040025 11 00	90° L Köşe 90° L Corner	24	0.376 kg	0.00272
001 043 040025 11 00	Ek Parça Connector	70	0.283 kg	0.00728
001 044 040025 11 00	Uç Tapa Blind Cap	25	0.152 kg	0.00128



Ürün Kodu	Product Code	001 060 100050 20 00
Ambalaj Şekli	Packing Type	Kutu - Box
Adet / m	Quantity / m	20 m
Ağırlık	Weight	17.700 kg
m ³ /	Volume	0.12022

AKSESUARLAR - ACCESSORIES

Kod Code	Ürün Product	Adet Quantity	Ağırlık Weight	m ³ Volume
001 061 100050 20 00	Ara Bölme Partition	150 m	20.400 kg	0.054
001 039 100050 11 00	İç Köşe Hareketli Internal Corner Live	12	0.583 kg	0.01045
001 040 100050 11 00	Dış Köşe Hareketli External Corner Live	8	0.182 kg	0.01045
001 041 100050 11 00	T Köşe T Corner	8	0.691 kg	0.01045
001 042 100050 11 00	90° L Köşe 90° L Corner	8	0.764 kg	0.01045
001 043 100050 11 00	Ek Parça Connector	12	1.056 kg	0.01045
001 44 100050 11 00	Uç Tapa Blind Cap	12	1.006 kg	0.01045
001 047 100001 11 00	PM Kasası 1'li Socket Assembly Frame Single	100	0.899	0.01050
001 047 100002 11 00	PM Kasası 2'li Socket Assembly Frame Double	20	0.5407 kg	0.01045
001 047 100003 11 00	PM Kasası 3'lü Socket Assembly Frame Triple	-	-	-

KENDİNDEN KAPAKLI KANALLAR

CABLE TRUNKING WITH INTRINSIC COVER



Kendinden Yapışkanlı
Self-Adhesive

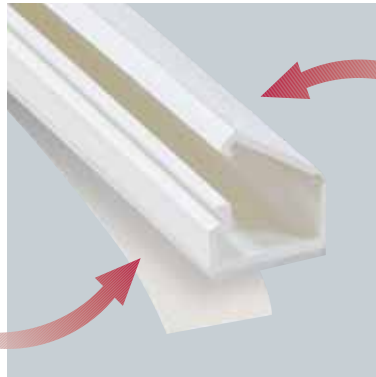

Kendinden Kapaklı
Intrinsic Cover

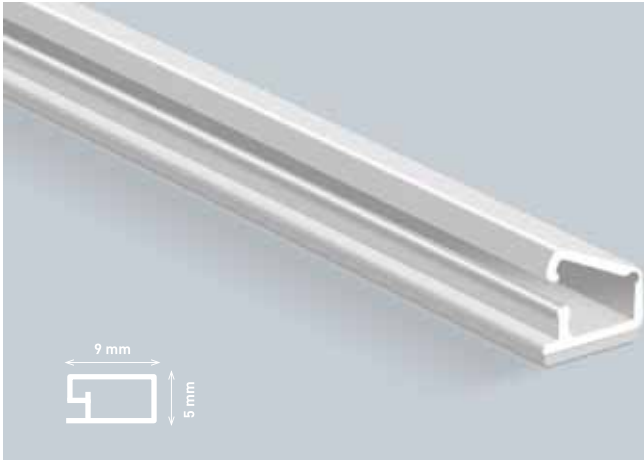
**9x5****Aksesuarsız**
Without Accessories

Ürün Kodu	Product Code	001 004 009005 20 00
Ambalaj Şekli	Packing Type	Kutu - Box
Adet / m	Quantity / m	500 m
Ağırlık	Weight	18.4 kg
m ³ /	Volume	0.0435

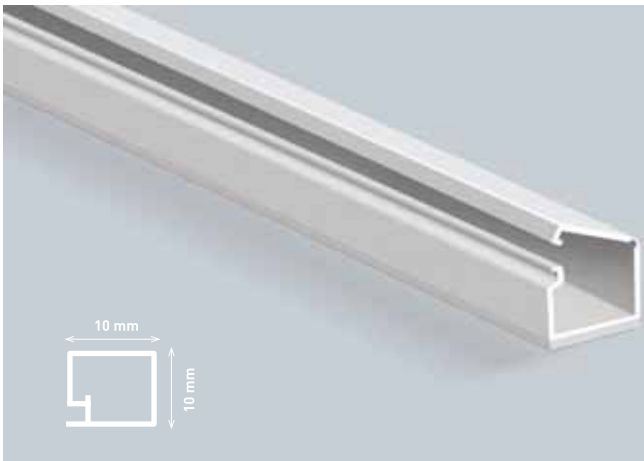
**10x10****Aksesuarsız**
Without Accessories

Ürün Kodu	Product Code	001 004 010010 20 00
Ambalaj Şekli	Packing Type	Kutu - Box
Adet / m	Quantity / m	330 m
Ağırlık	Weight	12.36 kg
m ³ /	Volume	0.0400

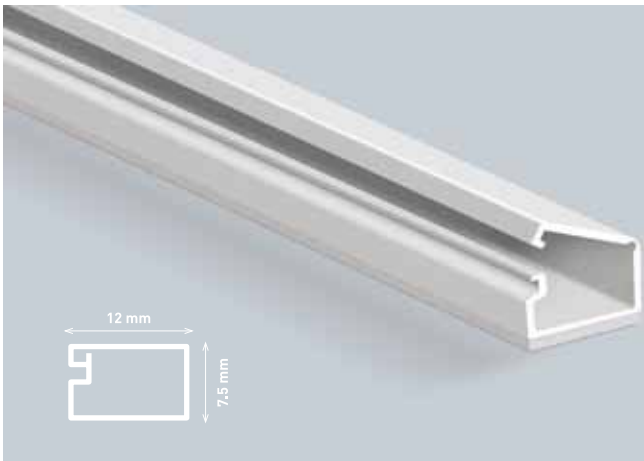
**12x7.5****Aksesuarsız**
Without Accessories

Ürün Kodu	Product Code	001 004 012007 20 00
Ambalaj Şekli	Packing Type	Kutu - Box
Adet / m	Quantity / m	350 m
Ağırlık	Weight	18.34 kg
m ³ /	Volume	0.0511

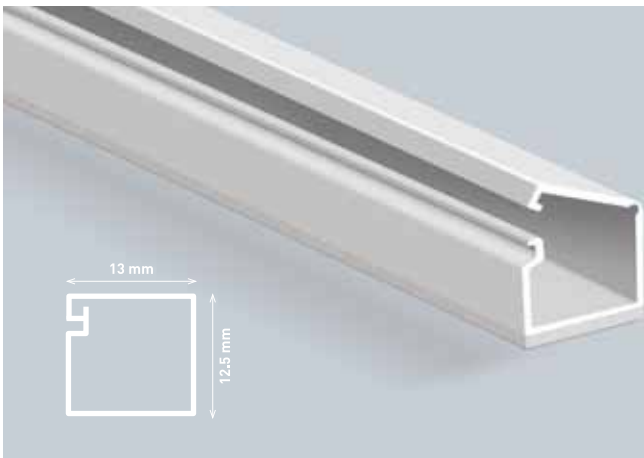
**13x12.5****Aksesuarsız**
Without Accessories

Ürün Kodu	Product Code	001 004 013012 20 00
Ambalaj Şekli	Packing Type	Kutu - Box
Adet / m	Quantity / m	300 m
Ağırlık	Weight	23.49 kg
m ³ /	Volume	0.0768

DIŐTAN KAPAKLI KANALLAR

CABLE TRUNKING WITH EXTERNAL COVER

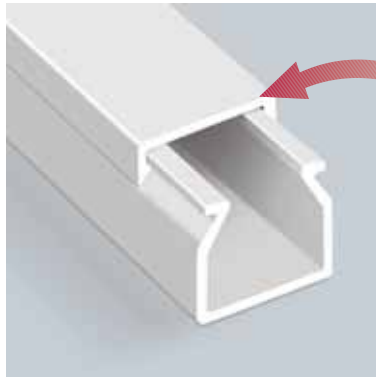

Diőtan Kapaklı
External Cover



10x8

Aksesuarsız
Without Accessories

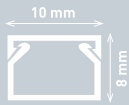

		EKO Serisi Series	MEKS Serisi Series
Ürün Kodu	Product Code	001 014 010008 20 00	001 002 010008 20 00
Ambalaj Şekli	Packing Type	Kutu - Box	Kutu - Box
Adet / m	Quantity / m	330 m	330 m
Ağırlık	Weight	15.85 kg	15.85 kg
m ³ /	Volume	0.04257	0.04257

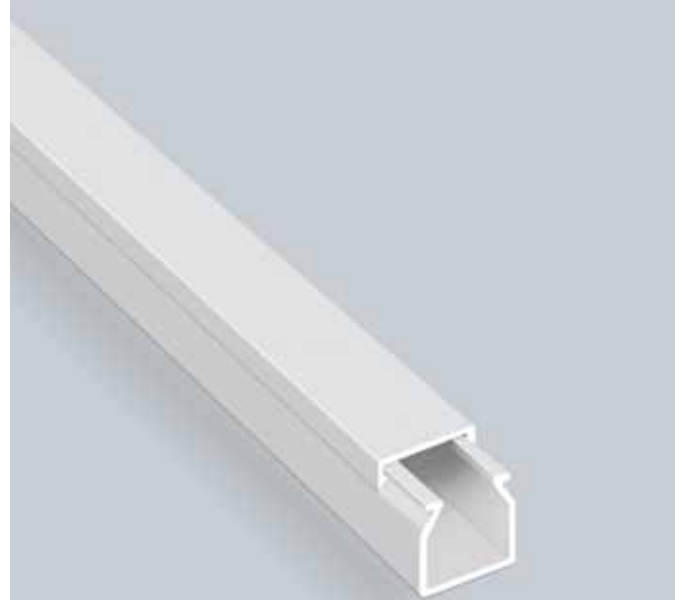

12x12

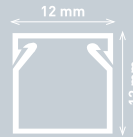

		EKO Serisi Series	MEKS Serisi Series	CANALEX Serisi Series
Ürün Kodu	Product Code	001 014 012012 20 00	001 002 012012 20 00	001 156 012012 20 00
Ambalaj Şekli	Packing Type	Kutu - Box	Kutu - Box	Kutu - Box
Adet / m	Quantity / m	250 m	250 m	250 m
Ağırlık	Weight	17.8 kg	17.8 kg	17.8 kg
m ³ /	Volume	0,053	0,053	0,053



AKSESUARLAR - ACCESSORIES

	Kod Code	Ürün Product	Adet Quantity	Ağırlık Weight	m ³ Volume
	001 039 012012 00 00	İç Köşe Internal Corner	60	0.127 kg	0.00126
	001 040 012012 00 00	Dış Köşe External Corner	60	0.170 kg	0.00126
	001 041 012012 00 00	T Köşe T Corner	60	0.145 kg	0.00126
	001 042 012012 00 00	90° L Köşe 90° L Corner	60	0.170 kg	0.00126
	001 043 012012 00 00	Ek Parça Connector	100	0.141 kg	0.00120
	001 044 012012 00 00	Uç Tapa Blind Cap	100	0.131 kg	0.0012



15x10

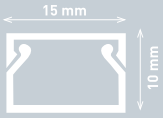

		EKO Serisi Series	MEKS Serisi Series	CANALEX Serisi Series
Ürün Kodu	Product Code	001 014 015010 20 00	001 002 015010 20 00	001 156 015010 20 00
Ambalaj Şekli	Packing Type	Kutu - Box	Kutu - Box	Kutu - Box
Adet / m	Quantity / m	250 m	250 m	250 m
Ağırlık	Weight	19.8 kg	19.8 kg	15.8 kg
m ³ /	Volume	0,053	0,053	0,053

AKSESUARLAR - ACCESSORIES

	Kod Code	Ürün Product	Adet Quantity	Ağırlık Weight	m ³ Volume
	001 039 015010 00 00	İç Köşe Internal Corner	60	0.133 kg	0.006
	001 040 015010 00 00	Dış Köşe External Corner	60	0.176 kg	0.00264
	001 041 015010 00 00	T Köşe T Corner	60	0.230 kg	0.00264
	001 042 015010 00 00	90° L Köşe 90° L Corner	60	0.176 kg	0.00264
	001 043 015010 00 00	Ek Parça Connector	100	0.162 kg	0.00260
	001 044 015010 00 00	Uç Tapa Blind Cap	100	0.152 kg	0.0026



15x15

Aksesuarsız
Without Accessories

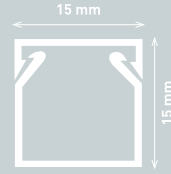

		EKO Serisi Series	MEKS Serisi Series
Ürün Kodu	Product Code	001 014 015015 20 00	001 002 015015 20 00
Ambalaj Şekli	Packing Type	Kutu - Box	Kutu - Box
Adet / m	Quantity / m	250 m	250 m
Ağırlık	Weight	23 kg.	23 kg.
m ³ /	Volume	0.085	0.085







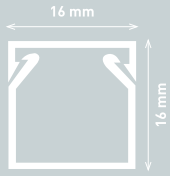

16x16



		EKO Serisi Series	MEKS Serisi Series	CANALEX Serisi Series
Ürün Kodu	Product Code	001 014 016016 20 00	001 002 016016 20 00	001 156 016016 20 00
Ambalaj Şekli	Packing Type	Kutu - Box	Kutu - Box	Kutu - Box
Adet / m	Quantity / m	250 m	250 m	250 m
Ağırlık	Weight	27.39 kg	27.39 kg	20.64 kg
m ³ /	Volume	0,07125	0,07125	0,07125

AKSESUARLAR - ACCESSORIES

	Kod Code	Ürün Product	Adet Quantity	Ağırlık Weight	m ³ Volume
	001 039 016016 00 00	İç Köşe Internal Corner	60	0.158 kg	0.0078
	001 040 016016 00 00	Dış Köşe External Corner	60	0.188 kg	0.00294
	001 041 016016 00 00	T Köşe T Corner	60	0.176 kg	0.00294
	001 042 016016 00 00	90° L Köşe 90° L Corner	60	0.242 kg	0.00294
	001 043 016016 00 00	Ek Parça Connector	100	0.192 kg	0.0029
	001 044 016016 00 00	Uç Tapa Blind Cap	100	0.182 kg	0.0029



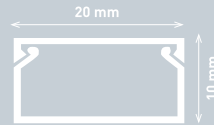

20x10



		EKO Serisi Series	MEKS Serisi Series	CANALEX Serisi Series
Ürün Kodu	Product Code	001 014 020010 20 00	001 002 020010 20 00	001 156 020010 20 00
Ambalaj Şekli	Packing Type	Kutu - Box	Kutu - Box	Kutu - Box
Adet / m	Quantity / m	200 m	200 m	200 m
Ağırlık	Weight	18.65 kg	18.65 kg	16.65 kg
m ³ /	Volume	0,0502	0,0502	0,0502

AKSESUARLAR - ACCESSORIES

	Kod Code	Ürün Product	Adet Quantity	Ağırlık Weight	m ³ Volume
	001 039 020010 00 00	İç Köşe Internal Corner	60	0.164 kg	0.00126
	001 040 020010 00 00	Dış Köşe External Corner	60	0.170 kg	0.00126
	001 041 020010 00 00	T Köşe T Corner	60	0.139 kg	0.00123
	001 042 020010 00 00	90° L Köşe 90° L Corner	60	0.212 kg	0.00125
	001 043 020010 00 00	Ek Parça Connector	100	0.162 kg	0.00120
	001 044 020010 00 00	Uç Tapa Blind Cap	100	0.152 kg	0.0012

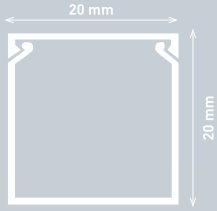
**20x20****Aksesuarsız**
Without Accessories**EKO** Serisi Series**MEKS** Serisi Series

Ürün Kodu	Product Code	001 014 020020 20 00	001 002 020020 20 00
Ambalaj Şekli	Packing Type	Kutu - Box	Kutu - Box
Adet / m	Quantity / m	144 m	144 m
Ağırlık	Weight	19.16 kg	19.16 kg
m ³ /	Volume	0.07128	0.07128

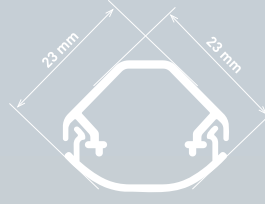
**23x23****Tavan Köşe Kanalı**
Ceiling Corner Trunking**MEKS** Serisi Series

Ürün Kodu	Product Code	001 002 023023 20 00
Ambalaj Şekli	Packing Type	Kutu - Box
Adet / m	Quantity / m	120 m
Ağırlık	Weight	23.94 kg
m ³ /	Volume	0.07536

AKSESUARLAR - ACCESSORIES

Kod Code	Ürün Product	Adet Quantity	Ağırlık Weight	m ³ Volume
 001 039 023023 00 00	İç Köşe Internal Corner	1	0.013 kg	0.00014
 001 040 023023 00 00	Dış Köşe External Corner	1	0.013 kg	0.00014
 001 041 023023 00 00	T Köşe T Corner	60	0.792 kg	0.00832
 001 042 023023 00 00	90° L Köşe 90° L Corner	60	0.255 kg	0.00293
 001 043 023023 00 00	Ek Parça Connector	100	1.320 kg	0.01386
 001 044 023023 00 00	Uç Tapa Blind Cap	100	0.167 kg	0.01386
 001 050 023023 00 00	Kablo Taşıyıcı Cable Carrier	-	-	-





25x16

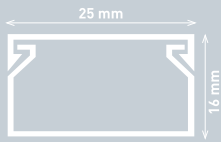

		EKO Seri Series	MEKS Seri Series	CANALEX Seri Series
Ürün Kodu	Product Code	001 014 025016 20 00	001 002 025016 20 00	001 156 025016 20 00
Ambalaj Şekli	Packing Type	Kutu - Box	Kutu - Box	Kutu - Box
Adet / m	Quantity / m	150 m	150 m	150 m
Ağırlık	Weight	20.66 kg	20.66 kg	18.11 kg
m ³ /	Volume	0,08235	0,08235	0,08235

AKSESUARLAR - ACCESSORIES

	Kod Code	Ürün Product	Adet Quantity	Ağırlık Weight	m ³ Volume
	001 013 025016 00 00	İç Köşe Internal Corner	40	0.323 kg	0.00292
	001 040 025016 00 00	Dış Köşe External Corner	40	0.432 kg	0.00260
	001 041 025016 00 00	T Köşe T Corner	30	0.324 kg	0.00260
	001 042 025016 00 00	90° L Köşe 90° L Corner	50	0.434 kg	0.00260
	001 043 025016 00 00	Ek Parça Connector	100	0.212 kg	0.00260
	001 044 025016 00 00	Uç Tapa Blind Cap	100	0.182 kg	0.00260
	001 047 025016 00 00	PM Kasası 1'li Socket Assembly Frame Single	12	1.161 kg	0.00731



25x25

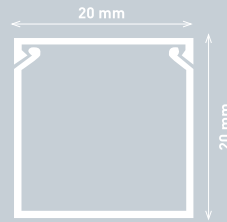

		EKO Seri Series	MEKS Seri Series	CANALEX Seri Series
Ürün Kodu	Product Code	001 014 025025 20 00	001 002 025025 20 00	001 156 025025 20 00
Ambalaj Şekli	Packing Type	Kutu - Box	Kutu - Box	Kutu - Box
Adet / m	Quantity / m	100 m	100 m	100 m
Ağırlık	Weight	20.16 kg	20.16 kg	17.36 kg
m ³ /	Volume	0,07820	0,07820	0,7820

AKSESUARLAR - ACCESSORIES

	Kod Code	Ürün Product	Adet Quantity	Ağırlık Weight	m ³ Volume
	001 013 025025 00 00	İç Köşe Internal Corner	40	0.343 kg	0.00292
	001 040 025025 00 00	Dış Köşe External Corner	40	0.448 kg	0.00260
	001 041 025025 00 00	T Köşe T Corner	30	0.327 kg	0.00260
	001 042 025025 00 00	90° L Köşe 90° L Corner	50	0.448 kg	0.00260
	001 043 025025 00 00	Ek Parça Connector	100	0.126 kg	0.00260
	001 044 025025 00 00	Uç Tapa Blind Cap	100	0.263 kg	0.00260
	001 047 025025 00 00	PM Kasası 1'li Socket Assembly Frame Single	12	1.161 kg	0.00731

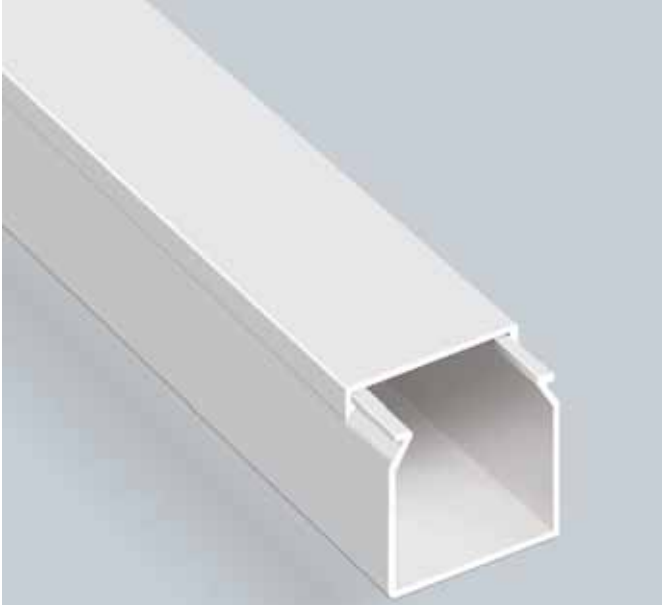
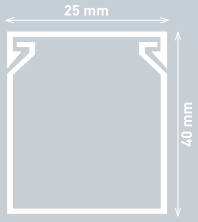
**25x40****Aksesuarsız**
Without Accessories

		EKO Serisi Series	MEKS Serisi Series
Ürün Kodu	Product Code	001 014 025040 20 00	001 002 025040 20 00
Ambalaj Şekli	Packing Type	Kutu - Box	Kutu - Box
Adet / m	Quantity / m	80 m	80 m
Ağırlık	Weight	24.843 kg	24.843 kg
m ³ /	Volume	0,09664	0,09664

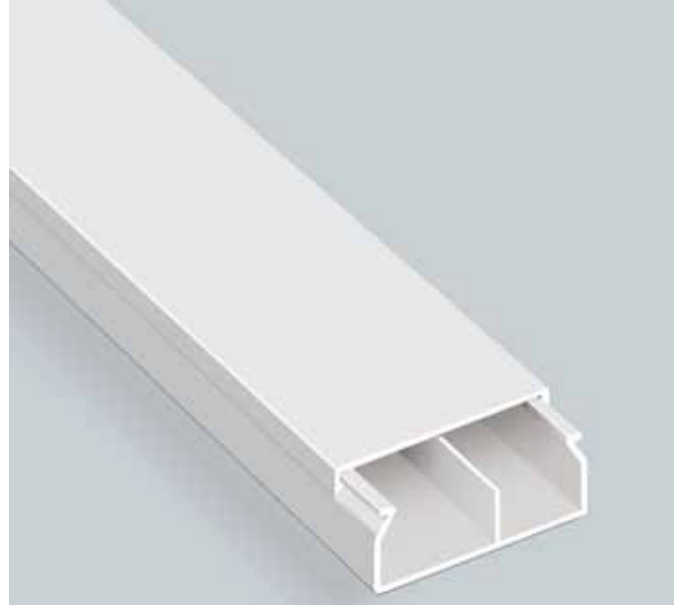
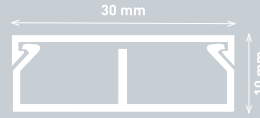
**30x10****Bölmeli**
Partitioned

		EKO Serisi Series	MEKS Serisi Series
Ürün Kodu	Product Code	001 014 930010 20 00	001 002 930010 20 00
Ambalaj Şekli	Packing Type	Kutu - Box	Kutu - Box
Adet / m	Quantity / m	140 m	140 m
Ağırlık	Weight	19.25 kg	19.25 kg
m ³ /	Volume	0,05026	0,05026

**AKSESUARLAR - ACCESSORIES**

	Kod Code	Ürün Product	Adet Quantity	Ağırlık Weight	m ³ Volume
	001 039 030010 00 00	İç Köşe Internal Corner	50	0.414 kg	0.00295
	001 040 030010 00 00	Dış Köşe External Corner	50	0.419 kg	0.00260
	001 041 030010 00 00	T Köşe T Corner	40	0.420 kg	0.00260
	001 042 030010 00 00	90° L Köşe 90° L Corner	50	0.419 kg	0.00260
	001 043 030025 00 00	Ek Parça Connector	100	0.202 kg	0.00260
	001 044 030025 00 00	Uç Tapa Blind Cap	100	0.202 kg	0.00260

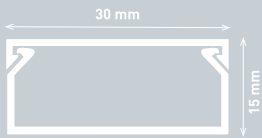
**30x15****Aksesuarsız**
Without Accessories

		EKO Serisi Series	MEKS Serisi Series
Ürün Kodu	Product Code	001 014 030015 20 00	001 002 030015 20 00
Ambalaj Şekli	Packing Type	Kutu - Box	Kutu - Box
Adet / m	Quantity / m	140 m	140 m
Ağırlık	Weight	21.84 kg	21.84 kg
m ³ /	Volume	0,0089	0,0089

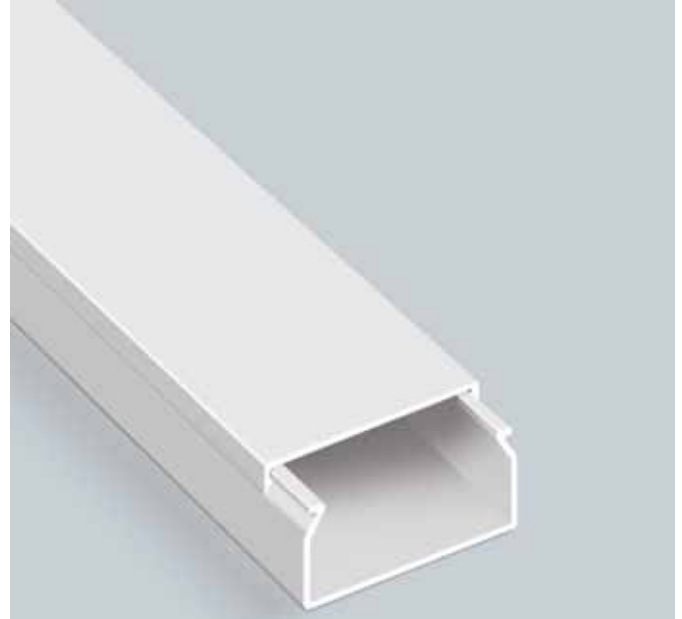
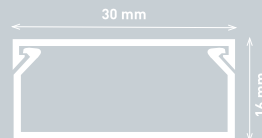
**30x16**

		EKO Serisi Series	MEKS Serisi Series	CANALEX Serisi Series
Ürün Kodu	Product Code	001 014 030016 20 00	001 002 030016 20 00	001 156 030016 20 00
Ambalaj Şekli	Packing Type	Kutu - Box	Kutu - Box	Kutu - Box
Adet / m	Quantity / m	140 m	140 m	140 m
Ağırlık	Weight	21.46 kg	21.46 kg	21.46 kg
m ³ /	Volume	0,07532	0,07532	0,07532

**AKSESUARLAR - ACCESSORIES**

	Kod Code	Ürün Product	Adet Quantity	Ağırlık Weight	m ³ Volume
	001 013 030016 00 00	İç Köşe Internal Corner	35	0.350 kg	0.00294
	001 040 030016 00 00	Dış Köşe External Corner	48	0.412 kg	0.00260
	001 041 030016 00 00	T Köşe T Corner	40	0.497 kg	0.00260
	001 042 030016 00 00	90° L Köşe 90° L Corner	50	0.475 kg	0.00260
	001 043 030025 00 00	Ek Parça Connector	100	0.232 kg	0.0014
	001 044 030025 00 00	Uç Tapa Blind Cap	100	0.303 kg	0.00260
	001 047 030016 00 00	PM Kasası 1'li Socket Assembly Frame Single	12	1.161 kg	0.00731

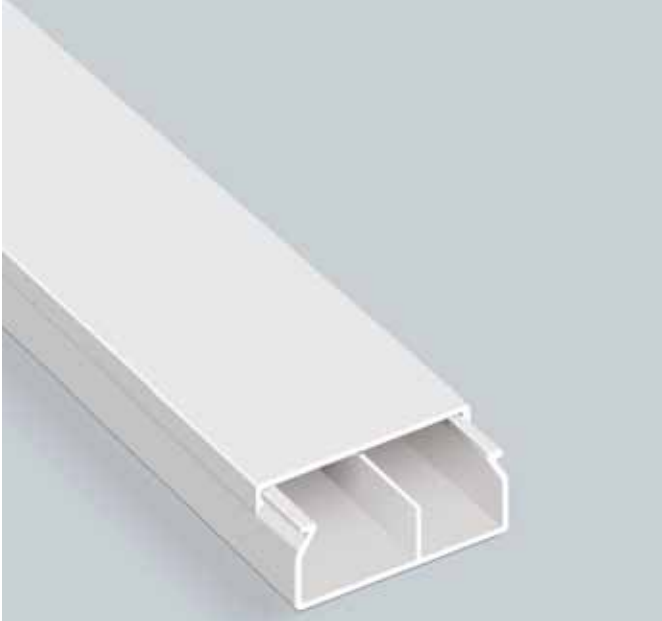
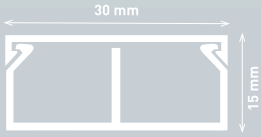
**30x16****Bölmeli**
Partitioned

		EKO Serisi Series	MEKS Serisi Series
Ürün Kodu	Product Code	001 014 030015 20 00	001 002 030015 20 00
Ambalaj Şekli	Packing Type	Kutu - Box	Kutu - Box
Adet / m	Quantity / m	140 m	140 m
Ağırlık	Weight	22.86 kg	22.86 kg
m ³ /	Volume	0,07812	0,07812

AKSESUARLAR - ACCESSORIES

Kod Code	Ürün Product	Adet Quantity	Ağırlık Weight	m ³ Volume
001 013 030016 00 00	İç Köşe Internal Corner	35	0.350 kg	0,00294
001 040 030016 00 00	Dış Köşe External Corner	48	0.412 kg	0,00260
001 041 030016 00 00	T Köşe T Corner	40	0.497 kg	0,00260
001 042 030016 00 00	90° L Köşe 90° L Corner	50	0.475 kg	0,00260
001 043 030025 00 00	Ek Parça Connector	100	0.232 kg	0,0014
001 044 030025 00 00	Uç Tapa Blind Cap	100	0.303 kg	0,00260
001 047 030016 00 00	PM Kasası 1'li Socket Assembly Frame Single	12	1.161 kg	0,00731

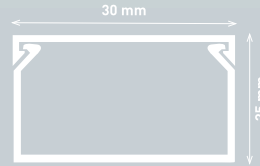
**30x25**

		EKO Serisi Series	MEKS Serisi Series
Ürün Kodu	Product Code	001 014 030025 20 00	001 002 030025 20 00
Ambalaj Şekli	Packing Type	Kutu - Box	Kutu - Box
Adet / m	Quantity / m	80 m	80 m
Ağırlık	Weight	16.34 kg	16.34 kg
m ³ /	Volume	0,07256	0,07256

AKSESUARLAR - ACCESSORIES

Kod Code	Ürün Product	Adet Quantity	Ağırlık Weight	m ³ Volume
001 039 030025 00 00	İç Köşe Internal Corner	32	0.401 kg	0,00291
001 040 030025 00 00	Dış Köşe External Corner	30	0.470 kg	0,00260
001 041 030025 00 00	T Köşe T Corner	24	0.381 kg	0,00260
001 042 030025 00 00	90° L Köşe 90° L Corner	30	0.355 kg	0,00260
001 043 030025 00 00	Ek Parça Connector	100	0.263kg	0,00260
001 044 030025 00 00	Uç Tapa Blind Cap	100	0.364 kg	0,00260
001 047 017421 00 00	PM Kasası 1'li Socket Assembly Frame Single	12	1.161 kg	0,00731

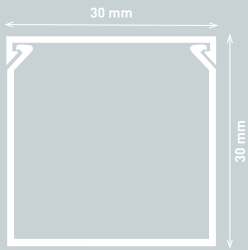
**30x30****Aksesuarsız**
Without Accessories

Ürün Kodu	Product Code	EKO Serisi Series	MEKS Serisi Series
		001 014 030030 20 00	001 002 030030 20 00
Ambalaj Şekli	Packing Type	Kutu - Box	Kutu - Box
Adet / m	Quantity / m	80 m	80 m
Ağırlık	Weight	19.24 kg	19.24 kg
m ³ /	Volume	0,032	0,032

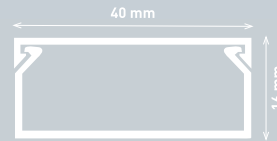
**40x16**

Ürün Kodu	Product Code	EKO Serisi Series	MEKS Serisi Series	CANALEX Serisi Series
		001 014 040016 20 00	001 002 040016 20 00	001 156 040016 20 00
Ambalaj Şekli	Packing Type	Kutu - Box	Kutu - Box	Kutu - Box
Adet / m	Quantity / m	100 m	100 m	100 m
Ağırlık	Weight	20.16 kg	20.16 kg	17.66 kg
m ³ /	Volume	0,08090	0,08090	0,08090

**AKSESUARLAR - ACCESSORIES**

Kod Code	Ürün Product	Adet Quantity	Ağırlık Weight	m ³ Volume
 001 039 040016 00 00	İç Köşe Internal Corner	32	0.375 kg	0.00979
 001 040 040016 00 00	Dış Köşe External Corner	30	0.970 kg	0.00240
 001 041 040016 00 00	T Köşe T Corner	24	0.402 kg	0.00730
 001 042 040016 00 00	90° L Köşe 90° L Corner	34	0.446 kg	0.00730
 001 043 040040 00 00	Ek Parça Connector	100	0.404 kg	0.00730
 001 044 040040 00 00	Uç Tapa Blind Cap	25	0.093 kg	0.00730
 001 047 040016 00 00	PM Kasası 1'li Socket Assembly Frame Single	12	1.161 kg	0.00731

**40x16****Bölmeli**
Partitioned

		EKO Serisi Series	MEKS Serisi Series
Ürün Kodu	Product Code	001 014 940016 20 00	001 002 940016 20 00
Ambalaj Şekli	Packing Type	Kutu - Box	Kutu - Box
Adet / m	Quantity / m	100 m	100 m
Ağırlık	Weight	23.16 kg	23.16 kg
m ³ /	Volume	0.0767	0.0767

**40x17****Tam Kapaklı - Full Cover**
Aksesuarsız - Without Accessories

		MEKS Serisi Series
Ürün Kodu	Product Code	001 002 040017 20 00
Ambalaj Şekli	Packing Type	Kutu - Box
Adet / m	Quantity / m	100 m
Ağırlık	Weight	26.16 kg
m ³ /	Volume	0.0809

AKSESUARLAR - ACCESSORIES

	Kod Code	Ürün Product	Adet Quantity	Ağırlık Weight	m ³ Volume
	001 039 040016 00 00	İç Köşe Internal Corner	32	0.375 kg	0.00979
	001 040 040016 00 00	Dış Köşe External Corner	30	0.970 kg	0.00240
	001 041 040016 00 00	T Köşe T Corner	24	0.402 kg	0.00730
	001 042 040016 00 00	90° L Köşe 90° L Corner	34	0.446 kg	0.00730
	001 043 040040 00 00	Ek Parça Connector	100	0.404 kg	0.00730
	001 044 040040 00 00	Uç Tapa Blind Cap	25	0.093 kg	0.00730
	001 047 040016 00 00	PM Kasası 1'li Socket Assembly Frame Single	12	1.161 kg	0.00731

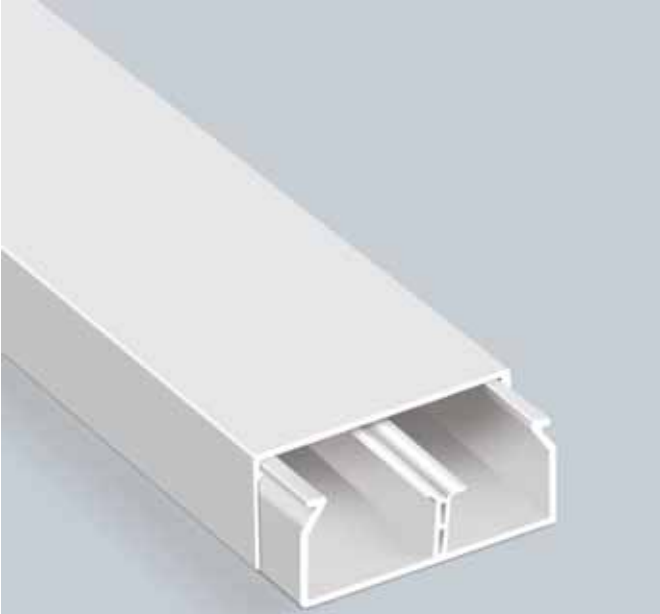

**40x17**

Tam Kapaklı Bölmeli
Full Cover and Partitioned
Aksesuarsız
Without Accessories

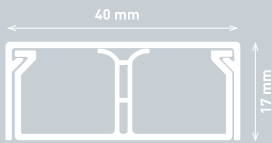
**MEKS** Serisi Series

Ürün Kodu	Product Code	001 002 940017 20 00
Ambalaj Şekli	Packing Type	Kutu - Box
Adet / m	Quantity / m	100 m
Ağırlık	Weight	26.16 kg
m ³ /	Volume	0.0809

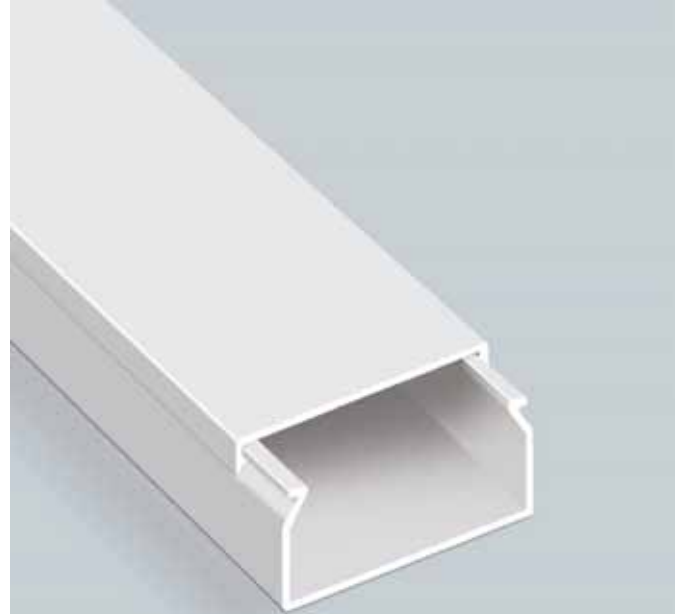
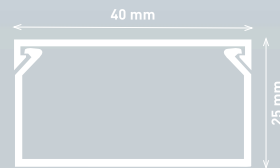
**40x25****EKO** Serisi Series**MEKS** Serisi Series**CANALEX** Serisi Series

Ürün Kodu	Product Code	001 014 040025 20 00	001 002 040025 20 00	001 156 040025 20 00
Ambalaj Şekli	Packing Type	Kutu - Box	Kutu - Box	Kutu - Box
Adet / m	Quantity / m	80 m	80 m	80 m
Ağırlık	Weight	22.043 kg	22.043 kg	17.243 kg
m ³ /	Volume	0,09592	0,09592	0,09592

**AKSESUARLAR - ACCESSORIES**

Kod Code	Ürün Product	Adet Quantity	Ağırlık Weight	m ³ Volume
 001 039 040025 00 00	İç Köşe Internal Corner	24	0.354 kg	0.01044
 001 040 040025 00 00	Dış Köşe External Corner	30	0.691 kg	0.00272
 001 041 040025 00 00	T Köşe T Corner	18	0.345 kg	0.00731
 001 042 040025 00 00	90° L Köşe 90° L Corner	24	0.376 kg	0.00272
 001 043 040040 00 00	Ek Parça Connector	70	0.283 kg	0.00728
 001 044 040040 00 00	Uç Tapa Blind Cap	25	0.152 kg	0.00128
 001 047 040025 00 00	PM Kasası 1'li Socket Assembly Frame Single	12	1.161 kg	0.00731

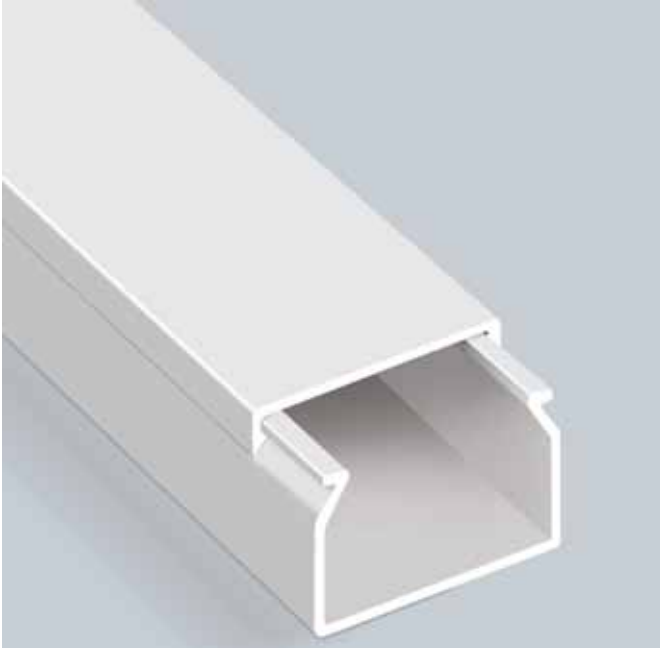

40x40

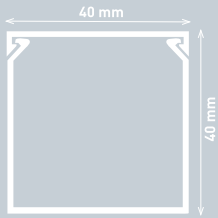

		EKO Serisi Series	MEKS Serisi Series	CANALEX Serisi Series
Ürün Kodu	Product Code	001 014 040040 20 00	001 002 040040 20 00	001 156 040040 20 00
Ambalaj Şekli	Packing Type	Kutu - Box	Kutu - Box	Kutu - Box
Adet / m	Quantity / m	50 m	50 m	50 m
Ağırlık	Weight	16.743 kg	16.743 kg	15.743 kg
m ³ /	Volume	0,10230	0,10230	0,10230

AKSESUARLAR - ACCESSORIES

	Kod Code	Ürün Product	Adet Quantity	Ağırlık Weight	m ³ Volume
	001 039 040040 00 00	İç Köşe Internal Corner	18	0.441 kg	0.010458
	001 040 040040 00 00	Dış Köşe External Corner	10	0.290 kg	0.00272
	001 041 040040 00 00	T Köşe T Corner	48	1.265 kg	0.0073
	001 042 040040 00 00	90° L Köşe 90° L Corner	60	1.260 kg	0.0073
	001 043 040040 00 00	Ek Parça Connector	100	0.434 kg	0.0073
	001 044 040040 00 00	Uç Tapa Blind Cap	25	0.146 kg	0.0073

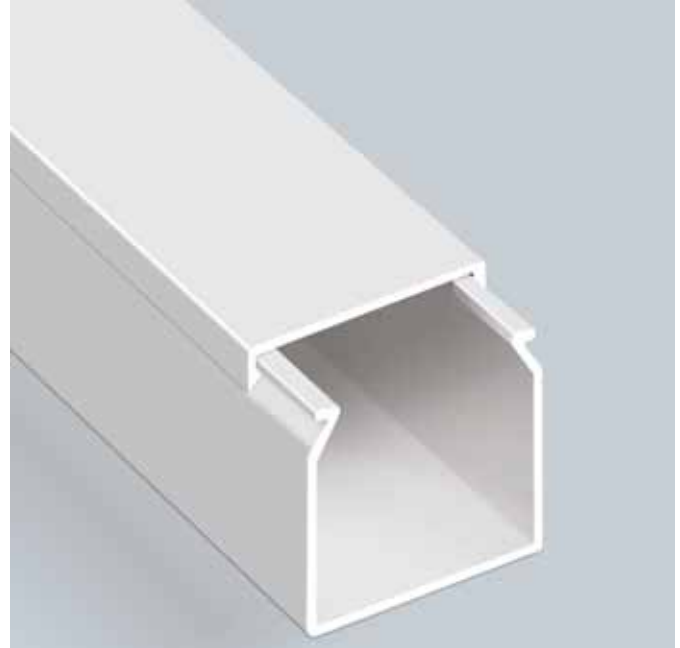

40x60

Aksesuarsız
Without Accessories

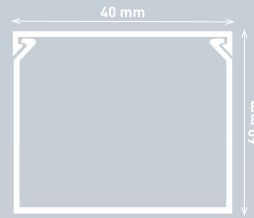

		EKO Serisi Series	MEKS Serisi Series
Ürün Kodu	Product Code	001 014 040060 20 00	001 002 040060 20 00
Ambalaj Şekli	Packing Type	Kutu - Box	Kutu - Box
Adet / m	Quantity / m	40 m	40 m
Ağırlık	Weight	21.518 kg	21.518 kg
m ³ /	Volume	0.11216	0.11216

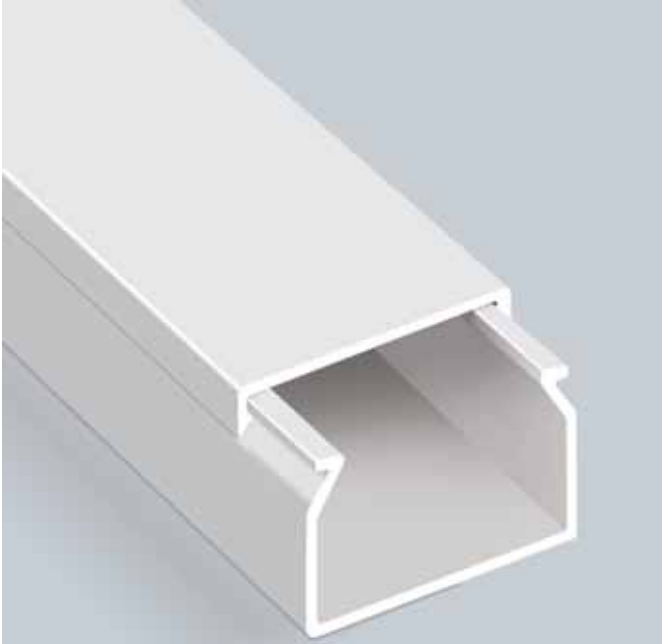
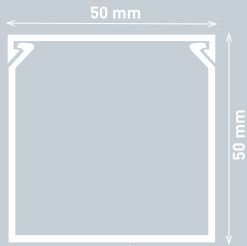

**50x50****Aksesuarsız**
Without Accessories**EKO** Serisi Series

Ürün Kodu	Product Code	001 014 050050 20 00
Ambalaj Şekli	Packing Type	Kutu - Box
Adet / m	Quantity / m	30 m
Ağırlık	Weight	13.243 kg
m ³ /	Volume	0.09663

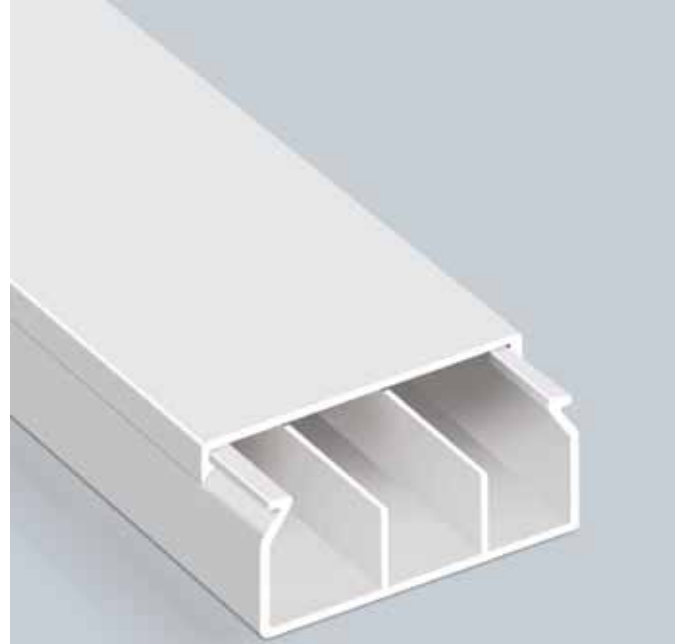
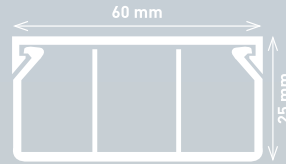
**60x25****Bölmeli**
Partitioned**EKO** Serisi Series**MEKS** Serisi Series

Ürün Kodu	Product Code	001 014 960025 20 00	001 002 960025 20 00
Ambalaj Şekli	Packing Type	Kutu - Box	Kutu - Box
Adet / m	Quantity / m	40 m	40 m
Ağırlık	Weight	17.14 kg	17.14 kg
m ³ /	Volume	0.07264	0.07264

**AKSESUARLAR - ACCESSORIES**

Kod Code	Ürün Product	Adet Quantity	Ağırlık Weight	m ³ Volume
 001 039 060025 00 00	İç Köşe Internal Corner	48	1.018 kg	0.00984
 001 040 060025 00 00	Dış Köşe External Corner	72	1.454 kg	0.00984
 001 041 060025 00 00	T Köşe T Corner	40	2.089 kg	0.00984
 001 042 060025 00 00	90° L Köşe 90° L Corner	60	2.042 kg	0.00984
 001 043 060060 00 00	Ek Parça Connector	60	0.455 kg	0.00272
 001 044 060025 00 00	Uç Tapa Blind Cap	50	0.434 kg	0.00272
 001 047 017421 00 00	PM Kasası 1'li Socket Assembly Frame Single	12	1.161 kg	0.00731



60x40



		EKO Seri Si Series	MEKS Seri Si Series	CANALEX Seri Si Series
Ürün Kodu	Product Code	001 014 060040 20 00	001 002 060040 20 00	001 156 060040 20 00
Ambalaj Şekli	Packing Type	Kutu - Box	Kutu - Box	Kutu - Box
Adet / m	Quantity / m	40 m	40 m	40 m
Ağırlık	Weight	21.118 kg	21.118 kg	15.518 kg
m ³ /	Volume	0,11084	0,11084	0,11084

AKSESUARLAR - ACCESSORIES

	Kod Code	Ürün Product	Adet Quantity	Ağırlık Weight	m ³ Volume
	001 039 060040 00 00	İç Köşe Internal Corner	26	0.441 kg	0.00985
	001 040 060040 00 00	Dış Köşe External Corner	32	0.290 kg	0.01011
	001 041 060040 00 00	T Köşe T Corner	32	1.265 kg	0.00986
	001 042 060040 00 00	90° L Köşe 90° L Corner	40	1.260 kg	0.01011
	001 043 060060 00 00	Ek Parça Connector	40	0.434 kg	0.00272
	001 044 060040 00 00	Uç Tapa Blind Cap	50	0.146 kg	0.00272



60x60

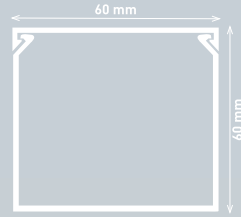

		EKO Seri Si Series	MEKS Seri Si Series	CANALEX Seri Si Series
Ürün Kodu	Product Code	001 014 060060 20 00	001 002 060060 20 00	001 156 060060 20 00
Ambalaj Şekli	Packing Type	Kutu - Box	Kutu - Box	Kutu - Box
Adet / m	Quantity / m	32 m	32 m	32 m
Ağırlık	Weight	20.957 kg	20.957 kg	18.717 kg
m ³ /	Volume	0,13590	0,13590	0,13590

AKSESUARLAR - ACCESSORIES

	Kod Code	Ürün Product	Adet Quantity	Ağırlık Weight	m ³ Volume
	001 039 060060 01 00	Hareketli İç Köşe Internal Corner Live	16	0.441 kg	0.00939
	001 040 060060 01 00	Hareketli Dış Köşe External Corner Live	16	0.290 kg	0.01011
	001 041 060060 00 00	T Köşe T Corner	20	1.265 kg	0.01044
	001 042 060060 00 00	90° L Köşe 90° L Corner	24	1.260 kg	0.01044
	001 043 060060 00 00	Ek Parça Connector	25	0.434 kg	0.01045
	001 044 060060 00 00	Uç Tapa Blind Cap	30	0.146 kg	0.01044

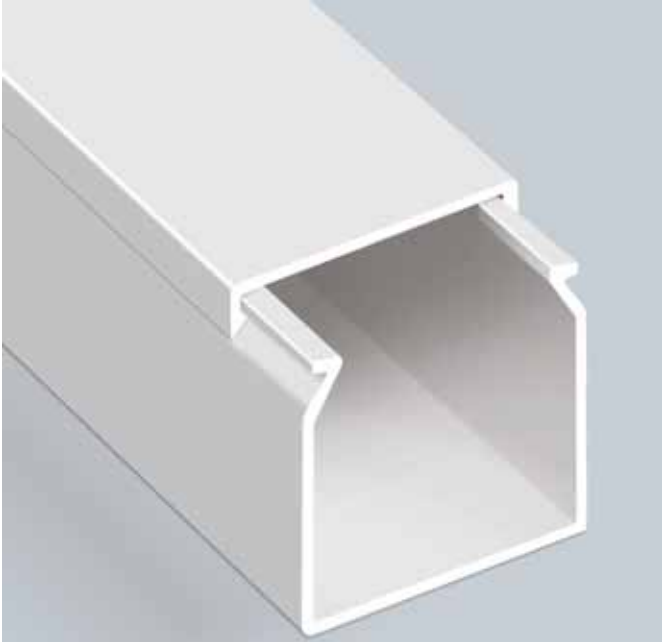
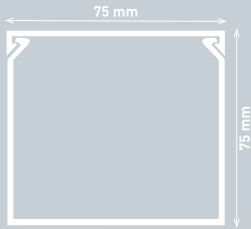



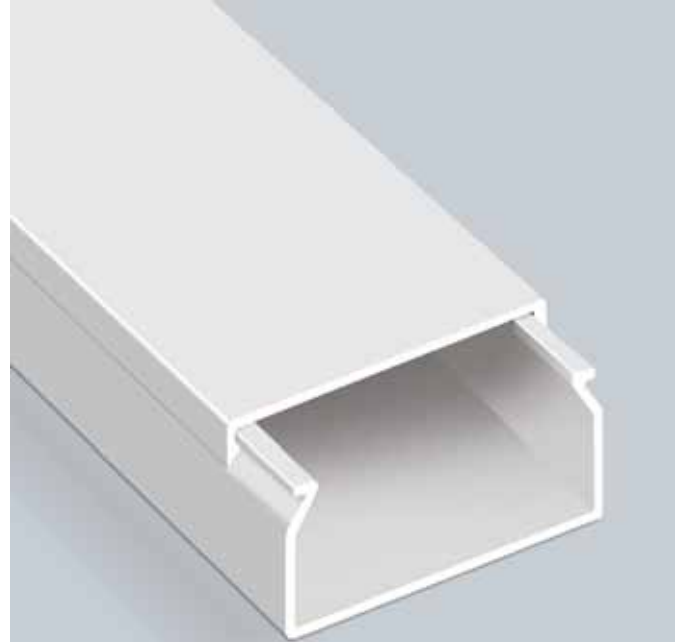

**75x75****Aksesuarsız**
Without Accessories**EKO** Serisi Series

Ürün Kodu	Product Code	001 014 075075 20 00
Ambalaj Şekli	Packing Type	Kutu - Box
Adet / m	Quantity / m	28 m
Ağırlık	Weight	25.993
m ³ /	Volume	0.17357

**80x40****EKO** Serisi Series**MEKS** Serisi Series**CANALEX** Serisi Series

Ürün Kodu	Product Code	001 014 060060 20 00	001 002 060060 20 00	001 156 060060 20 00
Ambalaj Şekli	Packing Type	Kutu - Box	Kutu - Box	Kutu - Box
Adet / m	Quantity / m	30 m	30 m	30 m
Ağırlık	Weight	19.518 kg	19.518 kg	17.118 kg
m ³ /	Volume	0,11217	0,11217	0,11217

**AKSESUARLAR - ACCESSORIES**

	Kod Code	Ürün Product	Adet Quantity	Ağırlık Weight	m ³ Volume
	001 039 080040 00 00	İç Köşe Internal Corner	18	0.441 kg	0.01046
	001 040 080040 00 00	Dış Köşe External Corner	8	0.290 kg	0.01046
	001 041 080040 00 00	T Köşe T Corner	12	1.265 kg	0.01046
	001 042 080040 00 00	90° L Köşe 90° L Corner	16	1.260 kg	0.01046
	001 043 080040 00 00	Ek Parça Connector	100	0.434 kg	0.01046
	001 044 080040 00 00	Uç Tapa Blind Cap	60	0.146 kg	0.01046



80x60

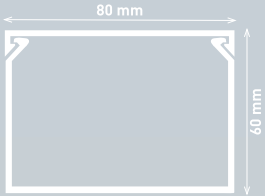

	EKO Serisi Series	MEKS Serisi Series	CANALEX Serisi Series
Ürün Kodu / Product Code	001 014 080060 20 00	001 002 080060 20 00	001 156 080060 20 00
Ambalaj Şekli / Packing Type	Kutu - Box	Kutu - Box	Kutu - Box
Adet / m	24 m	24 m	24 m
Ağırlık / Weight	18.557 kg	18.557 kg	16.157 kg
m ³ / Volume	0.13591	0.13591	0.13591

AKSESUARLAR - ACCESSORIES

Kod Code	Ürün Product	Adet Quantity	Ağırlık Weight	m ³ Volume
001 039 080060 00 00	İç Köşe Internal Corner	18	0.441 kg	0.00939
001 040 080060 00 00	Dış Köşe External Corner	8	0.290 kg	0.01045
001 041 080060 00 00	T Köşe T Corner	8	1.265 kg	0.00809
001 042 080060 00 00	90° L Köşe 90° L Corner	10	1.260 kg	0.00842
001 043 080060 00 00	Ek Parça Connector	80	0.434 kg	0.01011
001 044 080060 00 00	Uç Tapa Blind Cap	48	0.146 kg	0.01046

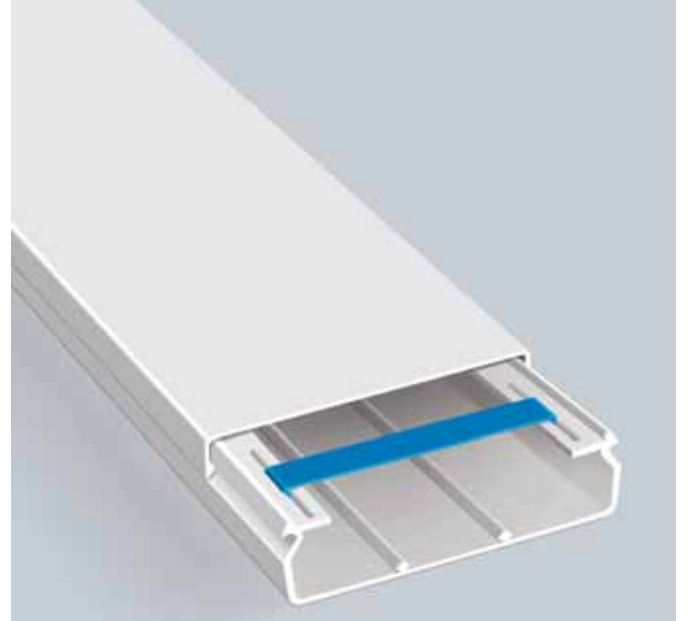

100x36

Kilitleme Aparatı
With Locking Apparatus

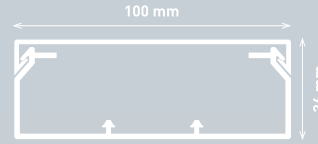

MEKS
Serisi Series

Ürün Kodu / Product Code	001 002 100036 20 00
Ambalaj Şekli / Packing Type	Kutu - Box
Adet / m	30 m
Ağırlık / Weight	31.307 kg
m ³ / Volume	0.13722

AKSESUARLAR - ACCESSORIES

Kod Code	Ürün Product	Adet Quantity	Ağırlık Weight	m ³ Volume
001 013 100036 00 00	Ara Bölme Partition	200 m	20.400 kg	0.054
001 039 100036 00 00	İç Köşe Internal Corner	8	0.583 kg	0.01045
001 039 100040 01 00	İç Köşe Hareketli Internal Corner Live	8	0.182 kg	0.01045
001 040 100040 00 00	Dış Köşe External Corner	8	0.691 kg	0.01045
001 040 100036 01 00	Dış Köşe Hareketli External Corner Live	8	0.764 kg	0.01045
001 041 100036 00 00	T Köşe T Corner	12	1.056 kg	0.01045
001 042 100036 00 00	90° L Köşe 90° L Corner	12	1.006 kg	0.01045
001 043 100060 00 00	Ek Parça Connector	100	0.899	0.01050
001 044 100060 00 00	Uç Tapa Blind Cap	20	0.5407 kg	0.01045
001 050 030004 00 00	Kilitleme Aparatı Locking Apparatus	-	-	-

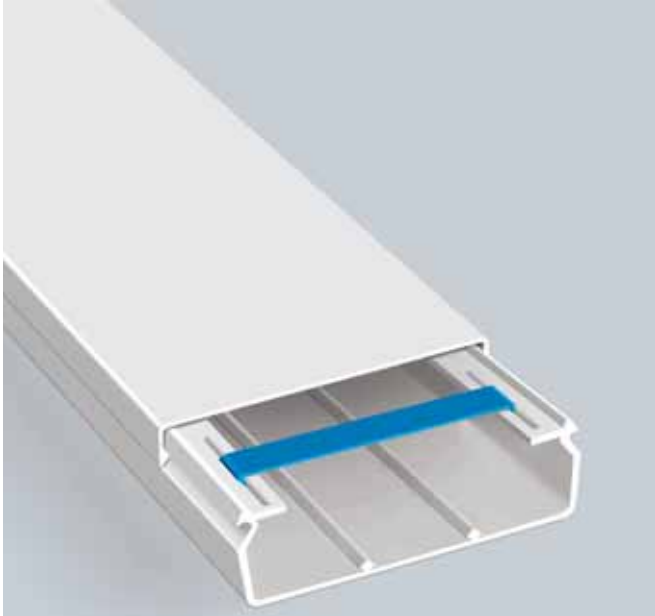
**100x40****Kilitleme Aparatı**
With Locking Apparatus

		EKO Serisi Series	MEKS Serisi Series	CANALEX Serisi Series
Ürün Kodu	Product Code	001 014 100040 20 00	001 002 100040 20 00	001 156 100040 20 00
Ambalaj Şekli	Packing Type	Kutu - Box	Kutu - Box	Kutu - Box
Adet / m	Quantity / m	24 m	24 m	24 m
Ağırlık	Weight	21.678 kg	24.318 kg	17.118 kg
m ³ /	Volume	0.11348	0.11348	0.11348

AKSESUARLAR - ACCESSORIES

	Kod Code	Ürün Product	Adet Quantity	Ağırlık Weight	m ³ Volume
	001 013 100040 00 00	Ara Bölme Partition	200 m	21.050 kg	0.054
	001 039 100040 00 00	İç Köşe Internal Corner	8	0.606 kg	0.01045
	001 039 100040 01 00	İç Köşe Hareketli Internal Corner Live	8	0.206 kg	0.00939
	001 040 100040 00 00	Dış Köşe External Corner	8	0.743 kg	0.00787
	001 040 100040 01 00	Dış Köşe Hareketli External Corner Live	8	0.599 kg	0.00629
	001 041 100040 00 00	T Köşe T Corner	12	1.150 kg	0.01045
	001 042 100040 00 00	90° L Köşe 90° L Corner	12	1.036 kg	0.01045
	001 043 100060 00 00	Ek Parça Connector	100	0.899 kg	0.01050
	001 044 100060 00 00	Uç Tapa Blind Cap	20	0.228 kg	0.00272
	001 050 030004 00 00	Kilitleme Aparatı Locking Apparatus	-	-	-

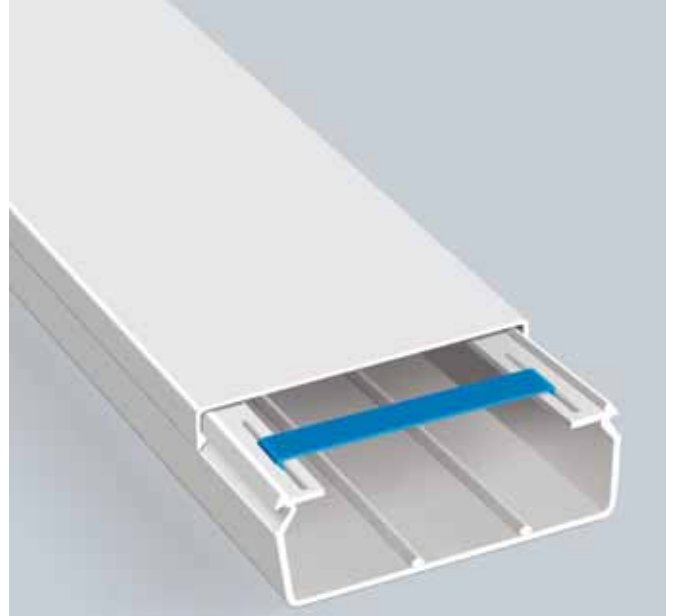
**100x48****Kilitleme Aparatı**
With Locking Apparatus

		MEKS Serisi Series
Ürün Kodu	Product Code	001 002 100048 20 00
Ambalaj Şekli	Packing Type	Kutu - Box
Adet / m	Quantity / m	24 m
Ağırlık	Weight	25.757 kg
m ³ /	Volume	0.13591

AKSESUARLAR - ACCESSORIES

	Kod Code	Ürün Product	Adet Quantity	Ağırlık Weight	m ³ Volume
	001 013 100048 00 00	Ara Bölme Partition	150 m	19.61 kg	0.07965
	001 039 100048 00 00	İç Köşe Internal Corner	8	0.749 kg	0.01045
	001 039 100060 01 00	İç Köşe Hareketli Internal Corner Live	8	0.770 kg	0.01045
	001 040 100048 00 00	Dış Köşe External Corner	8	0.808 kg	0.01045
	001 040 100060 01 00	Dış Köşe Hareketli External Corner Live	8	0.767 kg	0.01045
	001 041 100048 00 00	T Köşe T Corner	8	0.808 kg	0.01045
	001 042 100048 00 00	90° L Köşe 90° L Corner	8	0.707 kg	0.01045
	001 043 100060 00 00	Ek Parça Connector	100	0.899 kg	0.01050
	001 044 100060 00 00	Uç Tapa Blind Cap	20	0.540 kg	0.01045
	001 050 030004 00 00	Kilitleme Aparatı Locking Apparatus	-	-	-

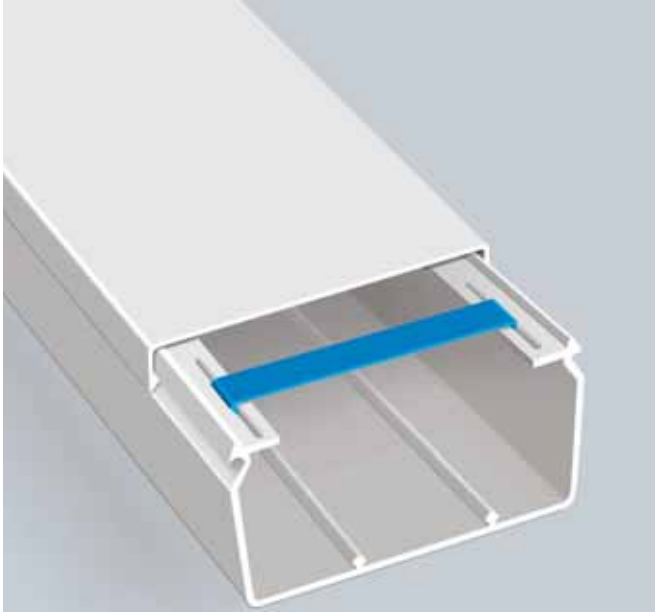

100x60

Kilitleme Aparatı
With Locking Apparatus

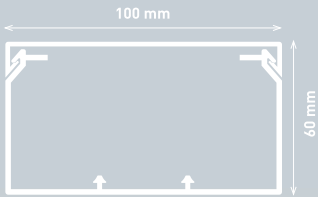

		EKO Seri Si Series	MEKS Seri Si Series	CANALEX Seri Si Series
Ürün Kodu	Product Code	001 014 100060 20 00	001 002 100060 20 00	001 156 100060 20 00
Ambalaj Şekli	Packing Type	Kutu - Box	Kutu - Box	Kutu - Box
Adet / m	Quantity / m	20 m	20 m	20 m
Ağırlık	Weight	22.757 kg	22.757 kg	18.557 kg
m ³ /	Volume	0,13590	0,13590	0,13590

AKSESUARLAR - ACCESSORIES

	Kod Code	Ürün Product	Adet Quantity	Ağırlık Weight	m ³ Volume
	001 013 100060 00 00	Ara Bölme Partition	130 m	19,36 kg	0,07956
	001 039 100060 00 00	İç Köşe Internal Corner	8	0,796 kg	0,01045
	001 039 100060 01 00	İç Köşe Hareketli Internal Corner Live	8	0,770 kg	0,00939
	001 040 100060 00 00	Dış Köşe External Corner	8	0,840 kg	0,01045
	001 040 100060 01 00	Dış Köşe Hareketli External Corner Live	10	0,958 kg	0,01045
	001 041 100060 00 00	T Köşe T Corner	8	0,890 kg	0,01045
	001 042 100060 00 00	90° L Köşe 90° L Corner	8	0,856 kg	0,01045
	001 043 100060 00 00	Ek Parça Connector	100	0,899 kg	0,01045
	001 044 100060 00 00	Uç Tapa Blind Cap	20	0,228 kg	0,00272
	001 050 030004 00 00	Kilitleme Aparatı Locking Apparatus	-	-	-



100x100

Aksesuarsız
Without Accessories

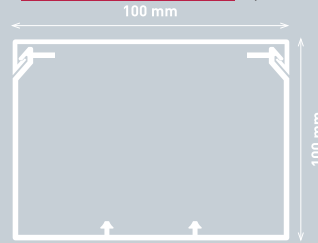

EKO Serisi Series

Ürün Kodu	Product Code	001 014 100100 20 00
Ambalaj Şekli	Packing Type	Kutu - Box
Adet / m	Quantity / m	320 m
Ağırlık	Weight	29.157 kg
m ³ /	Volume	0,13590

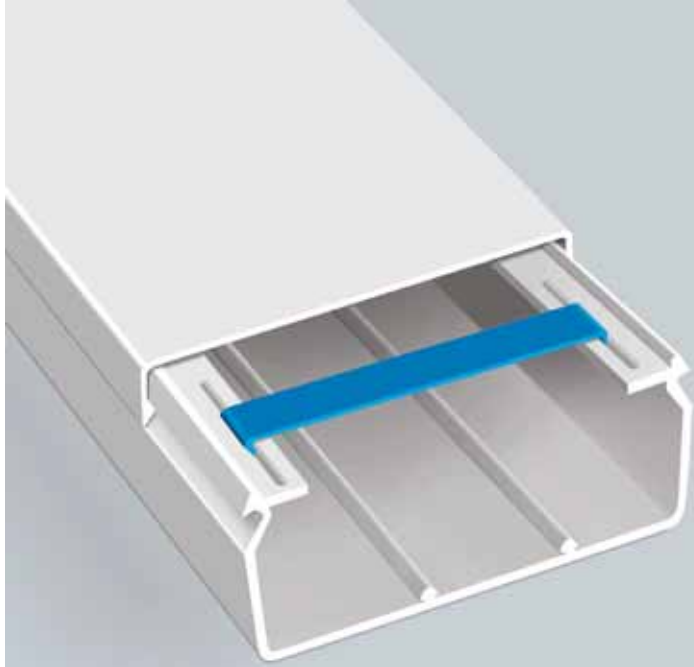
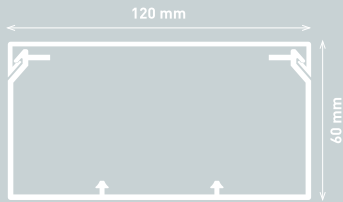

**120x60****Kilitleme Aparatı**
With Locking Apparatus

		EKO <small>Serisi Series</small>	MEKS <small>Serisi Series</small>
Ürün Kodu	Product Code	001 014 120060 20 00	001 002 120060 20 00
Ambalaj Şekli	Packing Type	Kutu - Box	Kutu - Box
Adet / m	Quantity / m	16 m	16 m
Ağırlık	Weight	23.677 kg	23.677 kg
m ³ /	Volume	0.13590	0.13590

AKSESUARLAR - ACCESSORIES

Kod Code	Ürün Product	Adet Quantity	Ağırlık Weight	m ³ Volume
 001 013 120060 20 00	Ara Bölme Partition	130 m	20.010 kg	0,07956
 001 039 120060 00 00	İç Köşe Internal Corner	8	0.749 kg	0,01045
 001 040 120060 00 00	Dış Köşe External Corner	8	0.803 kg	0,01045
 001 041 120060 00 00	T Köşe T Corner	8	0.867 kg	0,01045
 001 042 120060 00 00	90° L Köşe 90° L Corner	8	0.940 kg	0,01045
 001 043 120060 00 00	Ek Parça Connector	50	1.350 kg	0,01045
 001 044 120060 00 00	Uç Tapa Blind Cap	20	0.279 kg	0,00282
 001 050 120060 00 00	Kilitleme Aparatı Locking Apparatus	-	-	-



MEKS 100'LÜK SERİ PRİZ MONTAJ SETLERİ

Meks 100 Series Plug Socket Assembly Sets

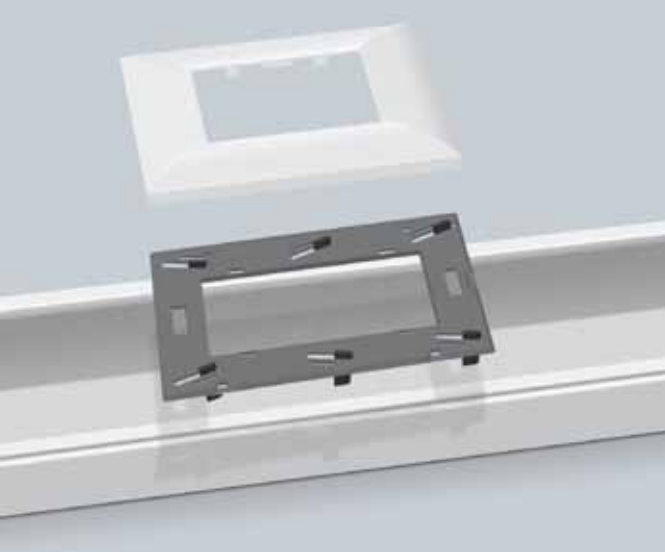

45x45
Tekli Çerçeve
Single Frame



Ürün Kodu	Product Code	001 047 040001 00 00
Ambalaj Şekli	Packing Type	Kutu - Box
Adet / m	Quantity / m	20 ad.
Ağırlık	Weight	1.216 kg
m ³ /	Volume	0.00262

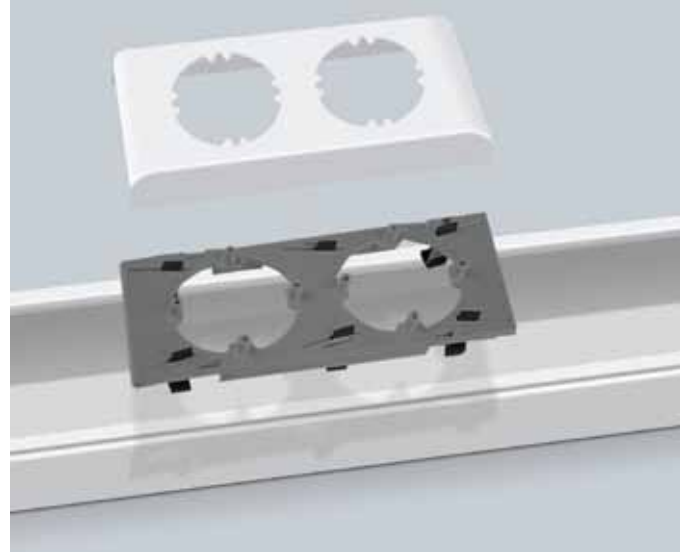

55x55
Tekli Çerçeve
Single Frame



Ürün Kodu	Product Code	001 047 020001 00 00
Ambalaj Şekli	Packing Type	Kutu - Box
Adet / m	Quantity / m	20 ad.
Ağırlık	Weight	1.216 kg
m ³ /	Volume	0.00262

45x45
İkili Çerçeve
Double Frame



Ürün Kodu	Product Code	001 047 040002 00 00
Ambalaj Şekli	Packing Type	Kutu - Box
Adet / m	Quantity / m	14 ad.
Ağırlık	Weight	1.143 kg
m ³ /	Volume	0.00536

55x55
İkili Çerçeve
Double Frame

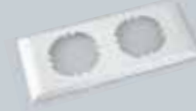

Ürün Kodu	Product Code	001 047 020002 00 00
Ambalaj Şekli	Packing Type	Kutu - Box
Adet / m	Quantity / m	14 ad.
Ağırlık	Weight	1.143 kg
m ³ /	Volume	0.00536

45x45
Üçlü Çerçeve
Triple Frame



Ürün Kodu	Product Code	001 047 040003 00 00
Ambalaj Şekli	Packing Type	Kutu - Box
Adet / m	Quantity / m	14 ad.
Ağırlık	Weight	1.417 kg
m ³ /	Volume	0.00793

55x55
Üçlü Çerçeve
Triple Frame



Ürün Kodu	Product Code	001 047 020003 00 00
Ambalaj Şekli	Packing Type	Kutu - Box
Adet / m	Quantity / m	14 ad.
Ağırlık	Weight	1.417 kg
m ³ /	Volume	0.00793

45x45
Dörtlü Çerçeve
Quartet Frame



Ürün Kodu	Product Code	001 047 980002 00 00
Ambalaj Şekli	Packing Type	Kutu - Box
Adet / m	Quantity / m	10 ad.
Ağırlık	Weight	1.21 kg
m ³ /	Volume	0.01104



45x22.5 Data
Priz Kapağı

45x22.5 Data
Socket Frame

888 049 050012



Data Konnektörü
1x8 CAT6

Data Connector
1x8 CAT 6

888 049 050032

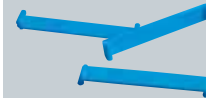

Kanal Kilitleme
Aparatı
Trunking Locking
Apparatus

001 050 030004 00 00

Kanalda zamanla oluşabilecek esnemelerin önüne geçer.

Prevents back last that could occur in the trunking.

İNGİLİZ NORMU PRİZ MONTAJ SETLERİ

BRITISH NORM PLUG SOCKET ASEMBLY SETS



İngiliz Normu Tekli Priz Tabanı

British Norm Single Socket Base

Ürün Kodu	Product Code	001 047 980002 0000
Ambalaj Şekli	Packing Type	Kutu - Box
Adet / m	Quantity / m	200
Ağırlık	Weight	3.85 kg
m ³ /	Volume	0.04



İngiliz Normu İkili Priz Tabanı

British Norm Double Socket Base

Ürün Kodu	Product Code	001 047 980002 0000
Ambalaj Şekli	Packing Type	Kutu - Box
Adet / m	Quantity / m	100
Ağırlık	Weight	2.475 kg
m ³ /	Volume	0.037



İngiliz Normu İkili Yüksek Tip Priz Tabanı

British Norm Double High Type Socket Base

Ürün Kodu	Product Code	001 047 990002 00 00
Ambalaj Şekli	Packing Type	Kutu - Box
Adet / m	Quantity / m	94
Ağırlık	Weight	5.076 kg
m ³ /	Volume	0.0017



Sivaaltı Anahtar Kasası (Kare Buat)

Flush Mounted Switch Casing (Square Junction Box)

Ürün Kodu	Product Code	001 166 000001 00 00
Ambalaj Şekli	Packing Type	Kutu - Box
Adet / m	Quantity / m	28
Ağırlık	Weight	1.18 kg
m ³ /	Volume	0.011

MEKSPLUS SERİSİ İÇTEN KAPAKLI KANALLAR

MEKSPLUS SERIES WITH INTRINSIC COVER TRUNKING

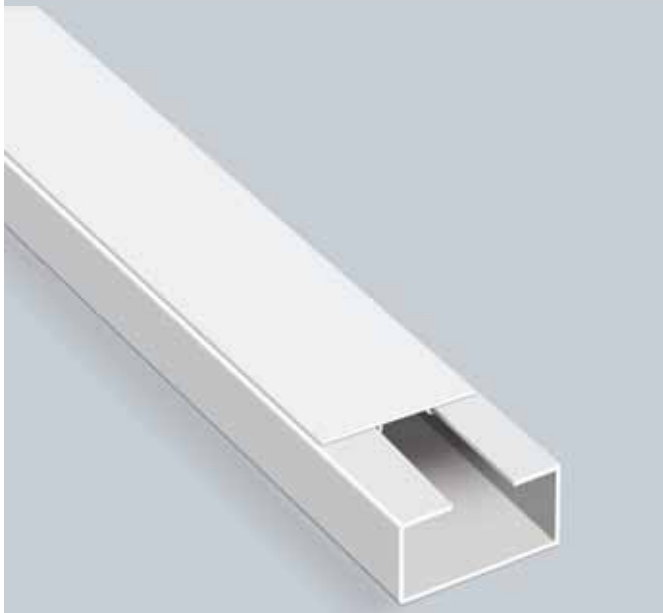
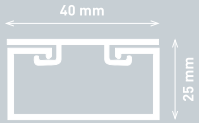

İçten Kapaklı
Intrinsic Cover

**40x25****Aksesuarsız**
Without Accessories**MEKSPLUS** Serisi - Series

Ürün Kodu	Product Code	001 003 040025 20 00
Ambalaj Şekli	Packing Type	Kutu - Box
Adet / m	Quantity / m	80 m
Ağırlık	Weight	26.843 kg
m ³ /	Volume	0.09592

**Koruma Bantlı**
Protecting Foil**100x37****EKO** Serisi - Series**MEKS** Serisi - Series**MEKSPLUS** Serisi - Series

Ürün Kodu	Product Code	001 014 100037 20 00	001 002 100037 20 00	001 003 100037 20 00
Ambalaj Şekli	Packing Type	Kutu - Box	Kutu - Box	Kutu - Box
Adet / m	Quantity / m	30 m	30 m	30 m
Ağırlık	Weight	29.067 kg	29.067 kg	29.067 kg
m ³ /	Volume	0.12546	0.12546	0.12546

AKSESUARLAR - ACCESSORIES

	Kod Code	Ürün Product	Adet Quantity	Ağırlık Weight	m ³ Volume
	001 013 100037 00 00	Ara Bölme Partition	200 m	19.65 kg	0.054
	001 039 100037 00 00	İç Köşe Internal Corner	12	0.927 kg	0.00984
	001 039 100050 01 00	İç Köşe Hareketli Internal Corner Live	12	0.696 kg	0.00984
	001 040 100037 00 00	Dış Köşe External Corner	8	0.570 kg	0.00984
	001 040 100050 01 00	Dış Köşe Hareketli External Corner Live	10	0.895 kg	0.01011
	001 041 100037 00 00	T Köşe T Corner	12	0.990 kg	0.01011
	001 042 100037 00 00	90° L Köşe 90° L Corner	12	0.856 kg	0.00984
	001 043 100050 00 00	Ek Parça Connector	100	1.5 kg	0.01050
	001 044 100037 00 00	Uç Tapa Blind Cap	50	0.702 kg	0.00272



Koruma Bantlı
Protecting Foil

100x41



Ürün Kodu	Product Code	MEKS	MEKSPLUS
		Serisi - Series	Serisi - Series
		001 002 100041 20 00	001 003 100041 20 00
Ambalaj Şekli	Packing Type	Kutu - Box	Kutu - Box
Adet / m	Quantity / m	324 m	324 m
Ağırlık	Weight	21.918 kg	21.918 kg
m ³ /	Volume	0.12221	0.12221

AKSESUARLAR - ACCESSORIES

Kod Code	Ürün Product	Adet Quantity	Ağırlık Weight	m ³ Volume
001 013 100040 20 00	Ara Bölme Partition	200 m	21.05 kg	0.054
001 039 100050 00 00	İç Köşe Internal Corner	8	0.443 kg	0.00984
001 039 100050 01 00	İç Köşe Hareketli Internal Corner Live	12	0.847 kg	0.00984
001 040 100050 00 00	Dış Köşe External Corner	8	0.722 kg	0.00984
001 040 100050 01 00	Dış Köşe Hareketli External Corner Live	10	0.895 kg	0.01011
001 041 100050 00 00	T Köşe T Corner	8	0.647 kg	0.00984
001 042 100050 00 00	90° L Köşe 90° L Corner	8	0.611 kg	0.00984
001 043 100050 00 00	Ek Parça Connector	100	1.394 kg	0.01011
001 044 100050 00 00	Uç Tapa Blind Cap	40	0.711 kg	0.00984



Koruma Bantlı
Protecting Foil

100x50



Kanal İçi Küp Buat
Duct Junction Cube



Ürün Kodu	Product Code	CANALEX	EKO	MEKS	MEKSPLUS
		Serisi - Series	Serisi - Series	Serisi - Series	Serisi - Series
		001 156 100050 20 00	001 014 100050 20 00	001 002 100050 20 00	001 003 100050 20 00
Ambalaj Şekli	Packing Type	Kutu Box	Kutu Box	Kutu Box	Kutu Box
Adet / m	Quantity / m	20 m	20 m	20 m	20 m
Ağırlık	Weight	17.79 kg	19.37 kg	21.46 kg	22.31 kg
m ³ /	Volume	0.127	0.127	0.127	0.127

AKSESUARLAR - ACCESSORIES

Kod Code	Ürün Product	Adet Quantity	Ağırlık Weight	m ³ Volume
001 013 100048 20 00	Ara Bölme Partition	150 m	19.61 kg	0.075
001 039 100050 00 00	İç Köşe Internal Corner	8	0.443 kg	0.00984
001 039 100050 01 00	İç Köşe Hareketli Internal Corner Live	12	0.847 kg	0.00984
001 040 100050 00 00	Dış Köşe External Corner	8	0.722 kg	0.00984
001 040 100050 01 00	Dış Köşe Hareketli External Corner Live	10	0.895 kg	0.01011
001 041 100050 00 00	T Köşe T Corner	8	0.647 kg	0.00984
001 042 100050 00 00	90° L Köşe 90° L Corner	8	0.611 kg	0.00984
001 043 100050 00 00	Ek Parça Connector	100	1.394 kg	0.01011
001 044 100050 00 00	Uç Tapa Blind Cap	40	0.711 kg	0.00984
001 043 100050 01 00	Ek parça (3'lü Set) Connector (3 set)	100	1.430 kg	0.00987
001 046 195100 00 00	Kanal İçi Küp Buat Duct Junction Cube	25	1.180 kg	0.0086



Koruma Bantlı
Protecting Foil

100x50

Kaidesiz
Compatible With Mounting
Without Base

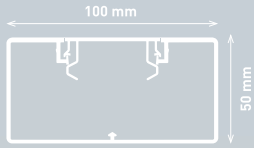

MEKPLUS Serisi Series

Ürün Kodu	Product Code	001 006 100050 20 00
Ambalaj Şekli	Packing Type	Kutu - Box
Adet / m	Quantity / m	20 m
Ağırlık	Weight	22.17 kg
m ³ /	Volume	0.120

AKSESUARLAR - ACCESSORIES

Kod Code	Ürün Product	Adet Quantity	Ağırlık Weight	m ³ Volume
 001 013 100048 20 00	Ara Bölme Partition	150 m	19.61 kg	0.075
 001 039 100051 00 00	İç Köşe Internal Corner	8	0.443 kg	0.00984
 001 040 100051 00 00	Dış Köşe External Corner	8	0.722 kg	0.00984
 001 041 100051 00 00	T Köşe T Corner	8	0.647 kg	0.01011
 001 042 100051 00 00	90° L Köşe 90° L Corner	8	0.611 kg	0.00984
 001 043 100051 00 00	Ek Parça Connector	100	1.394 kg	0.01011
 001 044 100051 00 00	Uç Tapa Blind Cap	40	0.711 kg	0.00984
 001 888 100050 00 00	Kilitleme Aparatı Locking Apparatus	50	-	-



120x70

Aksesuarsız
Without Accessories



MEKPLUS Serisi Series

Ürün Kodu	Product Code	001 003 120070 20 00
Ambalaj Şekli	Packing Type	Kutu - Box
Adet / m	Quantity / m	16 m
Ağırlık	Weight	25.673 kg
m ³ /	Volume	0.18189

AKSESUARLAR - ACCESSORIES

Kod Code	Ürün Product	Adet Quantity	Ağırlık Weight	m ³ Volume
 001 013 120070 20 00	Ara Bölme Partition	60 m	10.16 kg	0.080

NEW YENİ

100x50

Kaidesiz
Compatible With Mounting
Without Base





Koruma Bantlı
Protecting Foil



170x50



MEKSPLUS Serisi Series

Ürün Kodu	Product Code	001 003 170050 20 00
Ambalaj Şekli	Packing Type	Kutu - Box
Adet / m	Quantity / m	12 m
Ağırlık	Weight	19.23 kg
m ³ /	Volume	0.174

AKSESUARLAR - ACCESSORIES

Kod Code	Ürün Product	Adet Quantity	Ağırlık Weight	m ³ Volume
001 013 170070 20 00	Ara Bölme Partition	60 m	10.16 kg	0.080



170x70

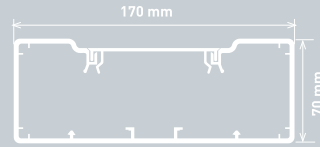

Aksesuarsız
Without Accessories

MEKSPLUS Serisi Series

Ürün Kodu	Product Code	001 003 170070 20 00
Ambalaj Şekli	Packing Type	Kutu - Box
Adet / m	Quantity / m	12 m
Ağırlık	Weight	29.23 kg
m ³ /	Volume	0.174

AKSESUARLAR - ACCESSORIES

Kod Code	Ürün Product	Adet Quantity	Ağırlık Weight	m ³ Volume
001 013 170070 20 00	Ara Bölme Partition	60 m	10.16 kg	0.080

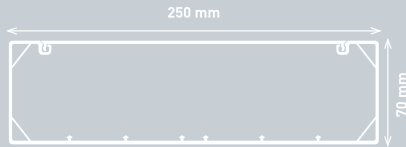
**250x70****Aksesuarsız**
Without Accessories**MEKPLUS** Serisi Series

Ürün Kodu	Product Code	001 003 250070 20 00
Ambalaj Şekli	Packing Type	Kutu - Box
Adet / m	Quantity / m	8 m
Ağırlık	Weight	24.073 kg
m ³ /	Volume	0.17357

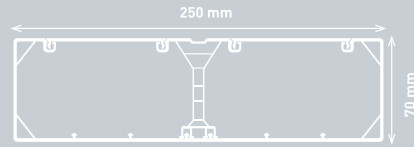
Priz Montaj Setsiz
Without Plug Socket Assembly Set**250x70****Bölmeli - Partitioned**
Aksesuarsız - Without Accessories**MEKPLUS** Serisi Series

Ürün Kodu	Product Code	001 003 250970 20 00
Ambalaj Şekli	Packing Type	Kutu - Box
Adet / m	Quantity / m	8 m
Ağırlık	Weight	28.713 kg
m ³ /	Volume	0.17357

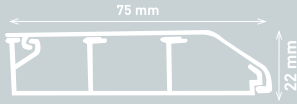

75x22

MEKS Serisi Series

Ürün Kodu	Product Code	001 002 075022 20 00
Ambalaj Şekli	Packing Type	Kutu - Box
Adet / m	Quantity / m	50 m
Ağırlık	Weight	33.743 kg
m ³ /	Volume	0.09685

AKSESUARLAR - ACCESSORIES

Kod Code	Ürün Product	Adet Quantity	Ağırlık Weight	m ³ Volume
001 039 075022 00 00	İç Köşe Internal Corner	1	0.015 kg.	0.00009
001 040 075022 00 00	Dış Köşe External Corner	1	0.016 kg.	0.00008
001 043 075022 00 00	Ek Parça Connector	1	0.004 kg.	0.00003
001 044 075022 01 00	Sağ Uç Tapa Blind Cap Right	1	0.004 kg.	0.00003
001 044 075022 02 00	Sol Uç Tapa Blind Cap Left	1	0.004 kg.	0.00003



74x20

Tam Kapaklı Bölmeli
Full Cover And Partitioned

EKO Serisi Series

MEKS Serisi Series

Ürün Kodu	Product Code	001 014 974020 20 00	001 002 974020 20 00
Ambalaj Şekli	Packing Type	Kutu - Box	Kutu - Box
Adet / m	Quantity / m	50 m	50 m
Ağırlık	Weight	27.493 kg	27.493 kg
m ³ /	Volume	0.0938	0.0938

AKSESUARLAR - ACCESSORIES

Kod Code	Ürün Product	Adet Quantity	Ağırlık Weight	m ³ Volume
001 039 074020 00 00	İç Köşe Internal Corner	20	0.250 kg	0.00262
001 040 074020 00 00	Dış Köşe External Corner	20	0.299 kg	0.00730
001 041 074020 00 00	T Köşe T Corner	30	1.182 kg	0.00730
001 042 074020 01 00	90° L Köşe 90° L Corner	40	1.260 kg	0.00730
001 043 074020 00 00	Ek Parça Connector	50	0.350 kg	0.00730
001 044 074020 00 00	Uç Tapa Blind Cap	50	0.505 kg	0.00730
001 047 0117420 00 00	P. M Kasası Socket Assembly Frame	6	0.574 kg	-
001 047 017421 00 00	P. M Kasası 1'li Socket Assembly Frame Single	12	1.161 kg	0.00731
001 043 017422 00 00	P. M Kasası 2'li Socket Assembly Frame Double	-	-	-
001 043 017423 00 00	P. M Kasası 3'lü Socket Assembly Frame Triple	-	-	-

MEKSPLUS SERİ PRİZ MONTAJ SETLERİ

Plug Socket Assembly Sets for Meksplus Series

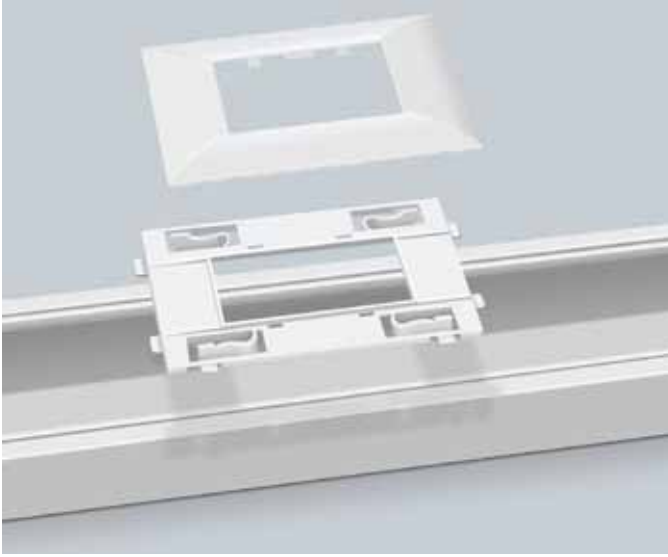

45x45 Tekli Çerçeve Single Frame



Ürün Kodu	Product Code	001 047 070001 00 00
Ambalaj Şekli	Packing Type	Kutu - Box
Adet / m	Quantity / m	20 ad.
Ağırlık	Weight	0.99 kg
m ³ /	Volume	0.00566

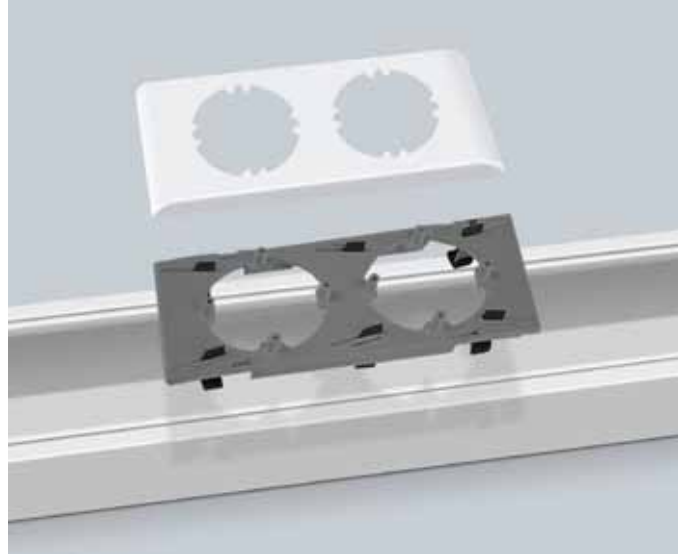

55x55 Tekli Çerçeve Single Frame



Ürün Kodu	Product Code	001 047 080001 00 00
Ambalaj Şekli	Packing Type	Kutu - Box
Adet / m	Quantity / m	20 ad.
Ağırlık	Weight	1.145 kg
m ³ /	Volume	0.0063

45x45 İkili Çerçeve Double Frame



Ürün Kodu	Product Code	001 047 070002 00 00
Ambalaj Şekli	Packing Type	Kutu - Box
Adet / m	Quantity / m	14 ad.
Ağırlık	Weight	0.923 kg
m ³ /	Volume	0.00566

55x55 İkili Çerçeve Double Frame



Ürün Kodu	Product Code	001 047 080002 00 00
Ambalaj Şekli	Packing Type	Kutu - Box
Adet / m	Quantity / m	14 ad.
Ağırlık	Weight	1.12 kg
m ³ /	Volume	0.0063

45x45 Üçlü Çerçeve Triple Frame



Ürün Kodu	Product Code	001 047 070003 00 00
Ambalaj Şekli	Packing Type	Kutu - Box
Adet / m	Quantity / m	12 ad.
Ağırlık	Weight	0.947 kg
m ³ /	Volume	0.0068

55x55 Üçlü Çerçeve Triple Frame



Ürün Kodu	Product Code	001 047 080003 00 00
Ambalaj Şekli	Packing Type	Kutu - Box
Adet / m	Quantity / m	10 ad.
Ağırlık	Weight	1.113 kg
m ³ /	Volume	0.0063

45x45 Dörtlü Çerçeve Quartet Frame



Ürün Kodu	Product Code	001 047 070004 00 00
Ambalaj Şekli	Packing Type	Kutu - Box
Adet / m	Quantity / m	10 ad.
Ağırlık	Weight	1.18 kg
m ³ /	Volume	0.0062

001 052 300001 00 00
45x45 Topraklı
Priz Çekirdekleri 45°
45x45 Earthed Socket Cores 45°



001 052 300002 00 00
45x45 UPS
Priz Çekirdekleri 45°
45x45 UPS Socket Cores 45°



001 052 200005 00 00
45x45 UPS ve Topraklı
Priz Birleştirme Aparatı
45x45 UPS and Grounded
Socket Joining Apparatus



888 049 050013
45x45 Data Priz Kapağı
45x45 Data Socket Cover





001 050 030003 00 00
100x37/50
Kanal Kilitleme Aparatı
Trunking Locking Apparatus

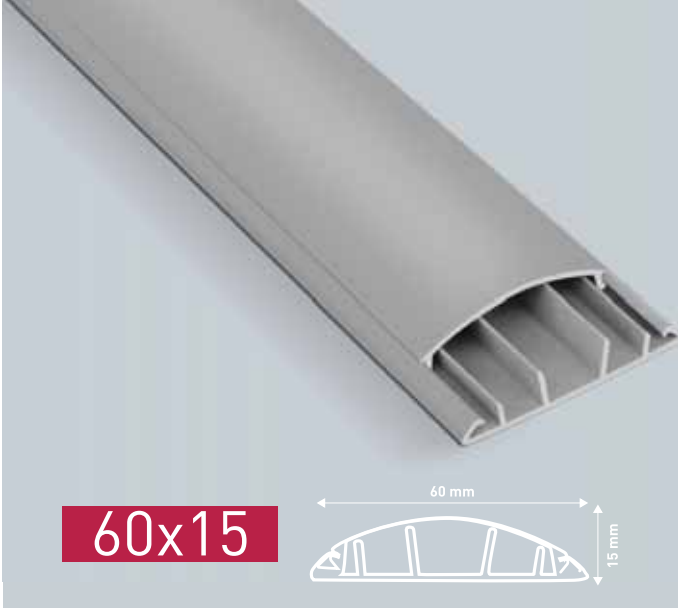



Ürün Kodu	Product Code	001 002 060015 20 17
Ambalaj Şekli	Packing Type	Kutu - Box
Adet / m	Quantity / m	500 m
Ağırlık	Weight	18,4 kg
m ³ /	Volume	0,0435





AKSESUARLAR - ACCESSORIES

Kod Code	Ürün Product	Adet Quantity	Ağırlık Weight	m ³ Volume
 001 041 060015 00 17	T Köşe T Corner	10	0,414 kg	0,00234
 001 042 060015 00 17	L Köşe L Corner	24	0,429 kg	0,00272
 001 043 060015 00 17	Ek Parça Connector	50	0,187 kg	0,00130
 001 044 060015 00 17	Uç Tapa Blind Cap	50	0,197 kg	0,00130



Ürün Kodu	Product Code	001 002 075018 20 17
Ambalaj Şekli	Packing Type	Kutu - Box
Adet / m	Quantity / m	60 m
Ağırlık	Weight	37,76 kg
m ³ /	Volume	0,0828





AKSESUARLAR - ACCESSORIES

Kod Code	Ürün Product	Adet Quantity	Ağırlık Weight	m ³ Volume
 001 041 075018 00 17	T Köşe T Corner	8	0,454 kg	0,00279
 001 042 075018 00 17	L Köşe L Corner	20	0,524 kg	0,00279
 001 043 075018 00 17	Ek Parça Connector	50	0,200 kg	0,00131
 001 044 075018 00 17	Uç Tapa Blind Cap	50	0,273 kg	0,00134



Ürün Kodu	Product Code	001 002 090020 20 17
Ambalaj Şekli	Packing Type	Kutu - Box
Adet / m	Quantity / m	40 m
Ağırlık	Weight	33,16 kg
m ³ /	Volume	0,07956

AKSESUARLAR - ACCESSORIES

Kod Code	Ürün Product	Adet Quantity	Ağırlık Weight	m ³ Volume
 001 041 090020 00 17	T Köşe T Corner	10	0,851 kg	0,00842
 001 042 090020 00 17	L Köşe L Corner	20	0,778 kg	0,00653
 001 043 090020 00 17	Ek Parça Connector	50	0,215 kg	0,00134
 001 044 090020 00 17	Uç Tapa Blind Cap	50	0,275 kg	0,00134

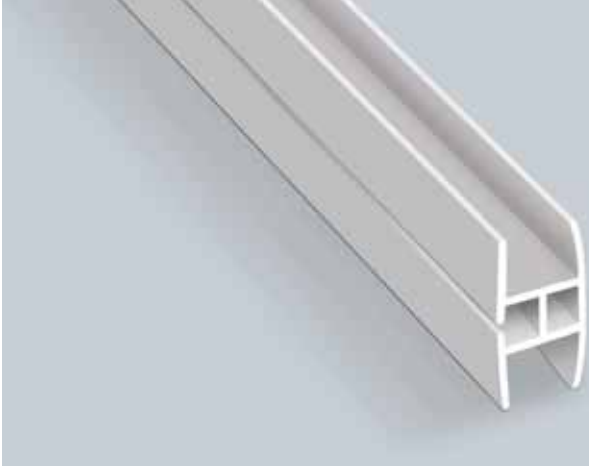

H Profil 8

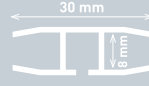

Ürün Kodu	Product Code	001 015 008000 20 00
Ambalaj Şekli	Packing Type	Kutu - Box
Adet / m	Quantity / m	100 m
Ağırlık	Weight	16.5 kg
m ³ /	Volume	0.03121

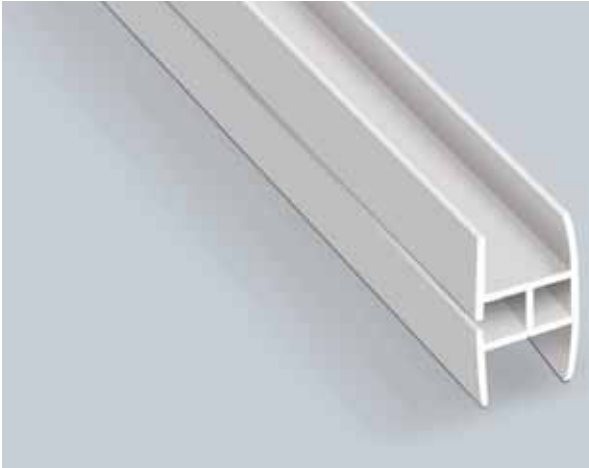

H Profil 10

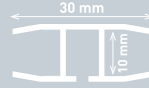

Ürün Kodu	Product Code	001 015 010000 20 00
Ambalaj Şekli	Packing Type	Kutu - Box
Adet / m	Quantity / m	100 m
Ağırlık	Weight	18 kg
m ³ /	Volume	0.03745

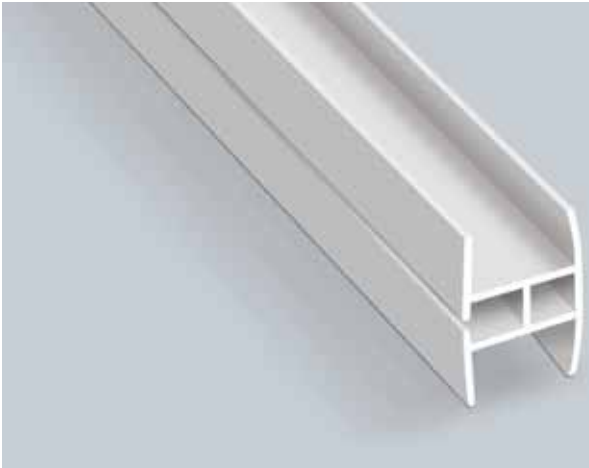

H Profil 12

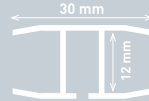

Ürün Kodu	Product Code	001 015 012000 20 00
Ambalaj Şekli	Packing Type	Kutu - Box
Adet / m	Quantity / m	100 m
Ağırlık	Weight	19.5 kg
m ³ /	Volume	0.04369



9.5x7



Seffaf Mini Kanal
(Kapaksız - Yapışkanlı)
Transparent Mini Trunking
(Without Cover - With Adhesive)

Ürün Kodu	Product Code	001 004 010007 20 44
Ambalaj Şekli	Packing Type	Kutu - Box
Adet / m	Quantity / m	500 m
Ağırlık	Weight	16.45 kg
m ³ /	Volume	0.0435

KLİMA KANALI

AIR CONDITIONING TRUNKING



Dış Uç Tapa
External Blind Cap

Ek Parça
Connector

İç Köşe
Internal Corner



90° L Köşe
90° L Corner

Kablo Tutucu
Cable Holder

Dış Köşe
External Corner

Duvar Geçisi
Wall Penetration

MEKS Serisi Series

Ürün Kodu	Product Code	001 002 075060 20 00
Ambalaj Şekli	Packing Type	Kutu - Box
Adet / m	Quantity / m	30 m
Ağırlık	Weight	19.543 kg
m ³ /	Volume	0.09663

AKSESUARLAR - ACCESSORIES

Kod Code	Ürün Product	Adet Quantity	Ağırlık Weight	m ³ Volume
 001 039 075060 00 00	İç Köşe Internal Corner	24	2.485 kg	0.00732
 001 040 075060 00 00	Dış Köşe External Corner	24	0.897 kg	0.00984
 001 042 075060 00 00	90° L Köşe 90° L Corner	18	1.040 kg	0.00984
 001 043 075060 00 00	Ek Parça Connector	40	0.440 kg	0.00280
 001 044 075060 01 00	İç Uç Tapa Internal Blind Cap	30	0.870 kg	0.01045
 001 044 075060 02 00	Dış Uç Tapa External Blind Cap	18	0.684 kg	0.01045
 001 050 030001 00 00	Duvar Geçişli Wall Penetration	-	-	-
 001 050 030002 00 00	Kablo Tutucu Cable Holder	-	-	-

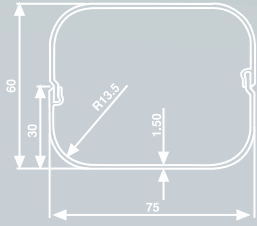
75x60

SİDEM SERİSİ KABLO KANALLARI

SIDEM SERIES CABLE TRUNKING



SİDEM

Tüm ebatlardaki kablo kanallarımız ve aksesuarları bu bölümdeki renk seçenekleri ile boyanabilir özelliklerdedir.

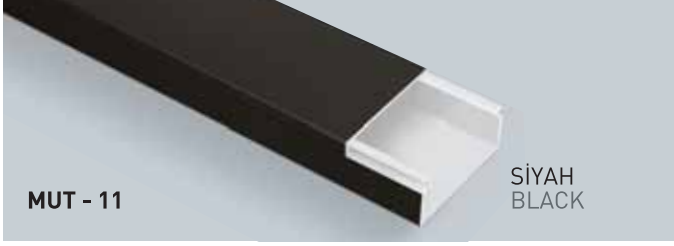
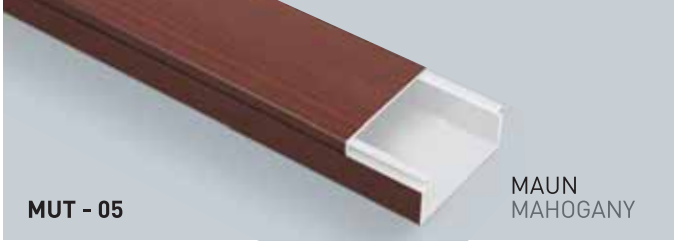
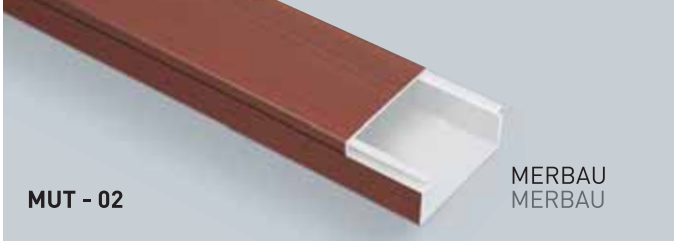

The cable trunking and accessories of all sizes can be painted with the available color options presented in this chapter.

RENK SEÇENEKLERİ COLOR OPTIONS**AHŞAP RENK SEÇENEKLERİ** WOOD COLOR OPTIONS**AKSESUARLAR** ACCESSORIES

Delikli Kablo Kanallarımızın Teknik Özellikleri

Technical Specifications Perforated Cable Trunking



Ultraviyole ışınlarına
karşı dayanıklıdır.
Resistance to
UV Light



Aşit buharına
dayanıklılıdır
Resistance to
acidic vapor

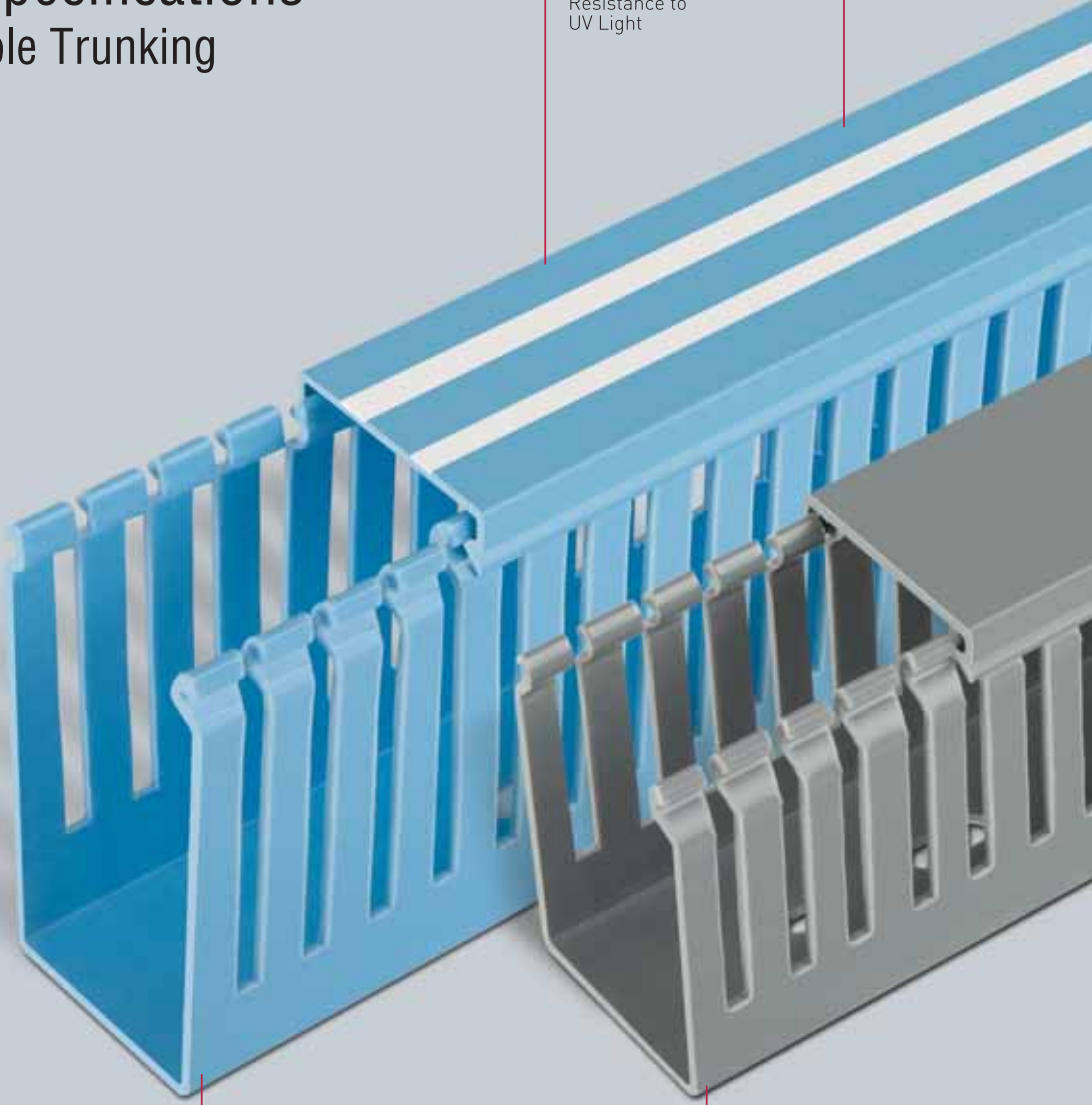

Daha pratik ve kolay montaj
için tüm kanallarımız çift
tarafli yapışkanlı bant ile
kullanılabilir

Adhesive models
are easy to install

-25°C+60°C

Aşırı soğuğa ve sicağa
karşı dayanıklı

Resistant to extreme
cold and heat

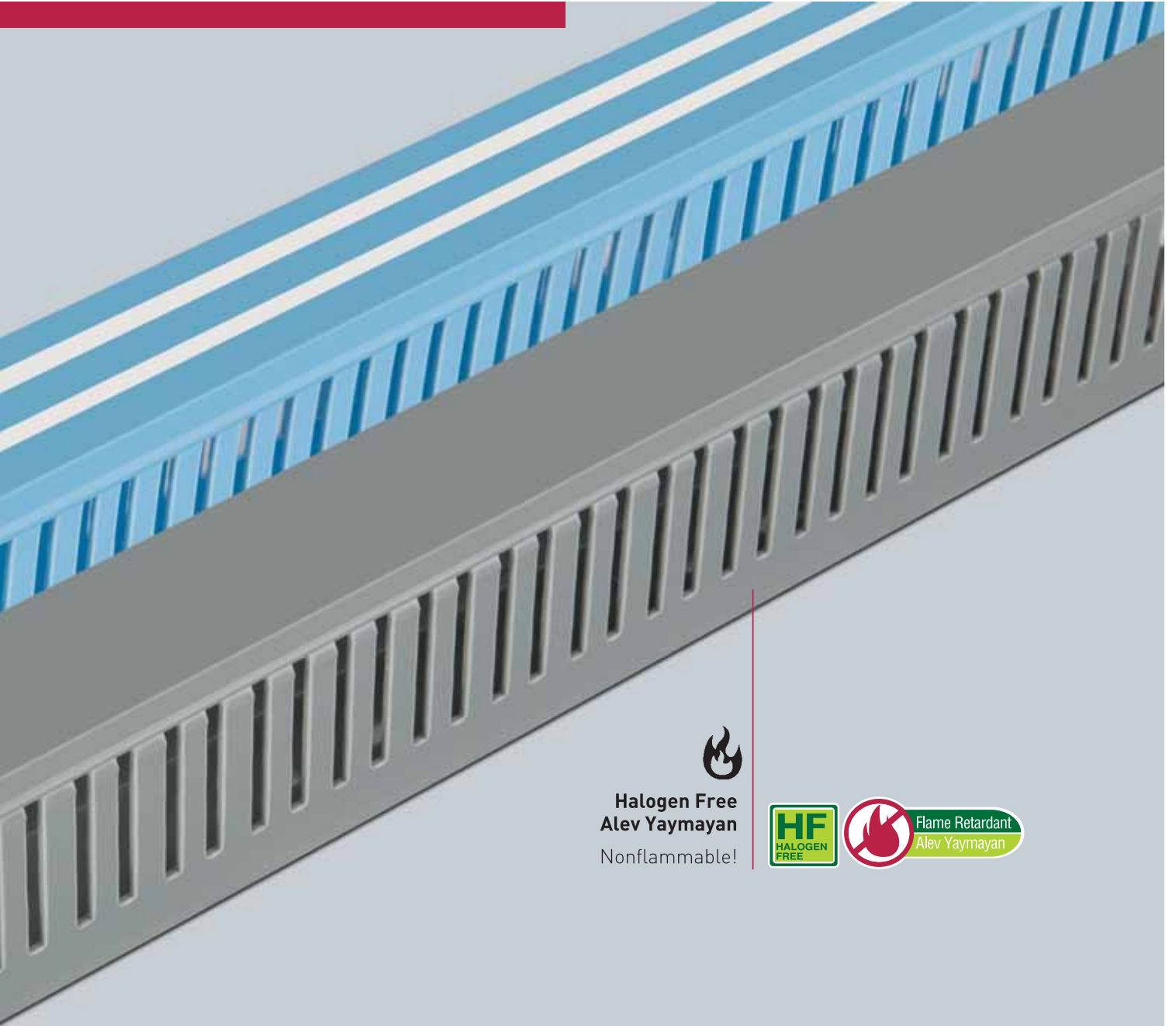

Halogen Free
Alev Yaymayan
Nonflammable!



Flame Retardant
Alev Yaymayan

**Kolay yapışmayı sağlayan,
Çift taraflı bant kullanılabilir.**

Double sided adhesive
Tape assuring easy fixation
Can be used

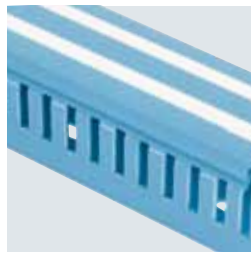
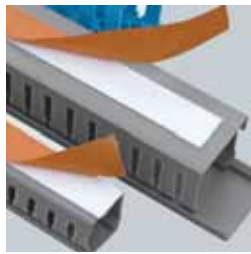

**Yazı yazmayı kolaylaştıran
beyaz bant**

Easy-to-write
white strips

**Kablo çıkışları için
belirli aralıklar**

Regular intervals for
cable outlets

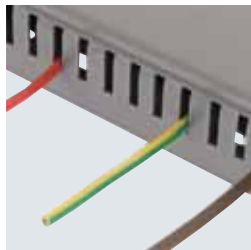

**Düzenli aralıklarla
montaj delikleri**

Assembly holes with
regular intervals

HALOGEN FREE DELİKLİ KABLO KANALI

HALOGEN FREE PERFORATED CABLE TRUNKING



Flame Retardant
Alev Yaymayan

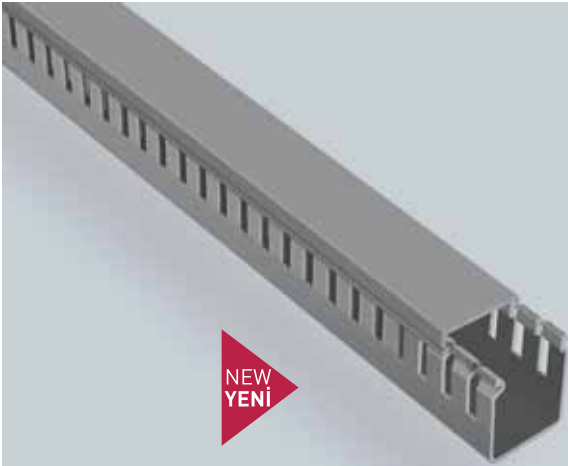

NEW
YENI



Flame Retardant
Alev Yaymayan

25x25

Gri
Grey

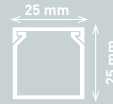

Ürün Kodu	Product Code	001 005 025025 20 17
Ambalaj Şekli	Packing Type	Kutu - Box
Adet / m	Quantity / m	128 m
Ağırlık	Weight	26.865 kg
m ³ /	Volume	0.0992

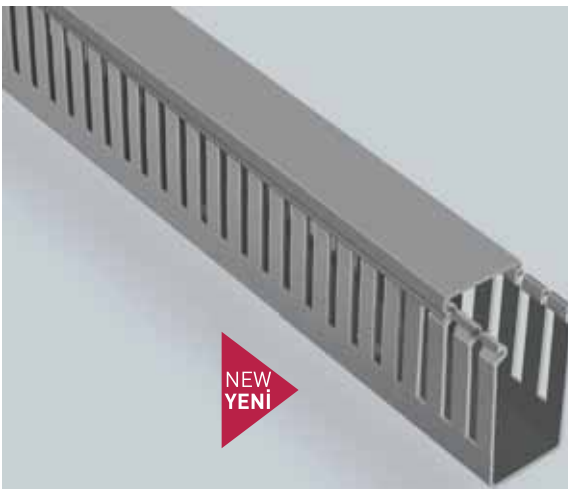

NEW
YENI



Flame Retardant
Alev Yaymayan

25x40

Gri
Grey

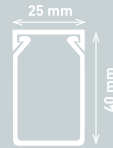

Ürün Kodu	Product Code	001 005 025040 20 17
Ambalaj Şekli	Packing Type	Kutu - Box
Adet / m	Quantity / m	80 m
Ağırlık	Weight	23,665 kg
m ³ /	Volume	0,0992

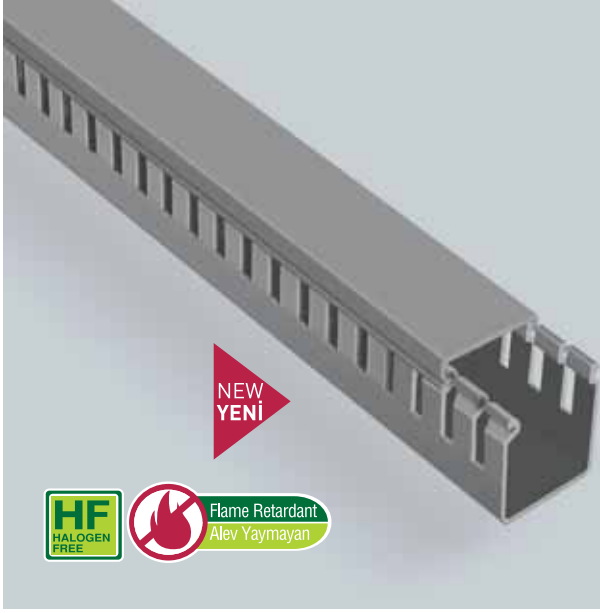
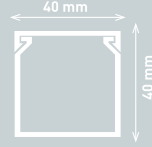
**40x40****Gri**
Grey

Ürün Kodu	Product Code	001 005 040040 20 17
Ambalaj Şekli	Packing Type	Kutu - Box
Adet / m	Quantity / m	50 m
Ağırlık	Weight	18.765 kg
m ³ /	Volume	0.0992

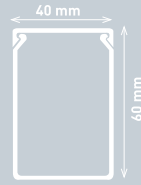
**40x60****Gri**
Grey

Ürün Kodu	Product Code	001 005 040060 20 17
Ambalaj Şekli	Packing Type	Kutu - Box
Adet / m	Quantity / m	48 m
Ağırlık	Weight	23.11 kg
m ³ /	Volume	0.1439

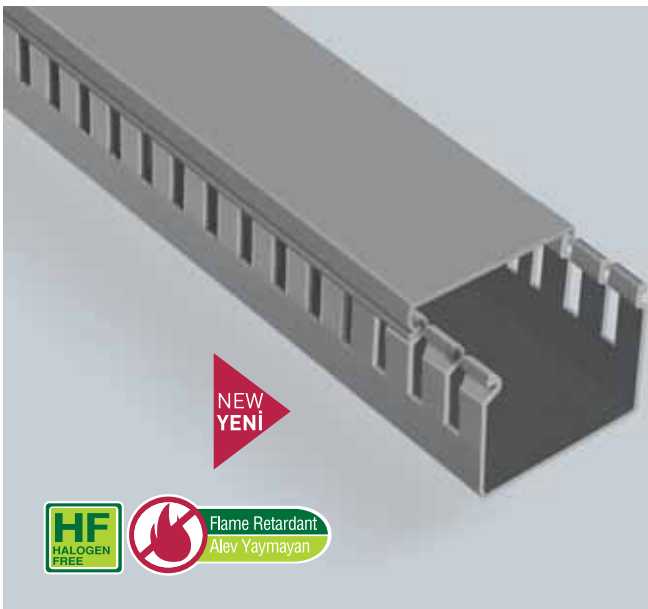
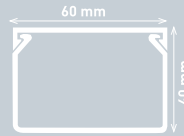
**60x40****Gri**
Grey

Ürün Kodu	Product Code	001 005 060040 20 17
Ambalaj Şekli	Packing Type	Kutu - Box
Adet / m	Quantity / m	48 m
Ağırlık	Weight	25.51 kg
m ³ /	Volume	0.1439

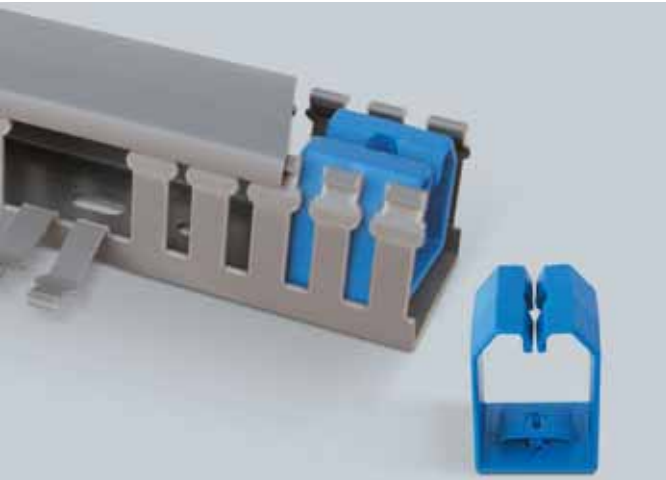
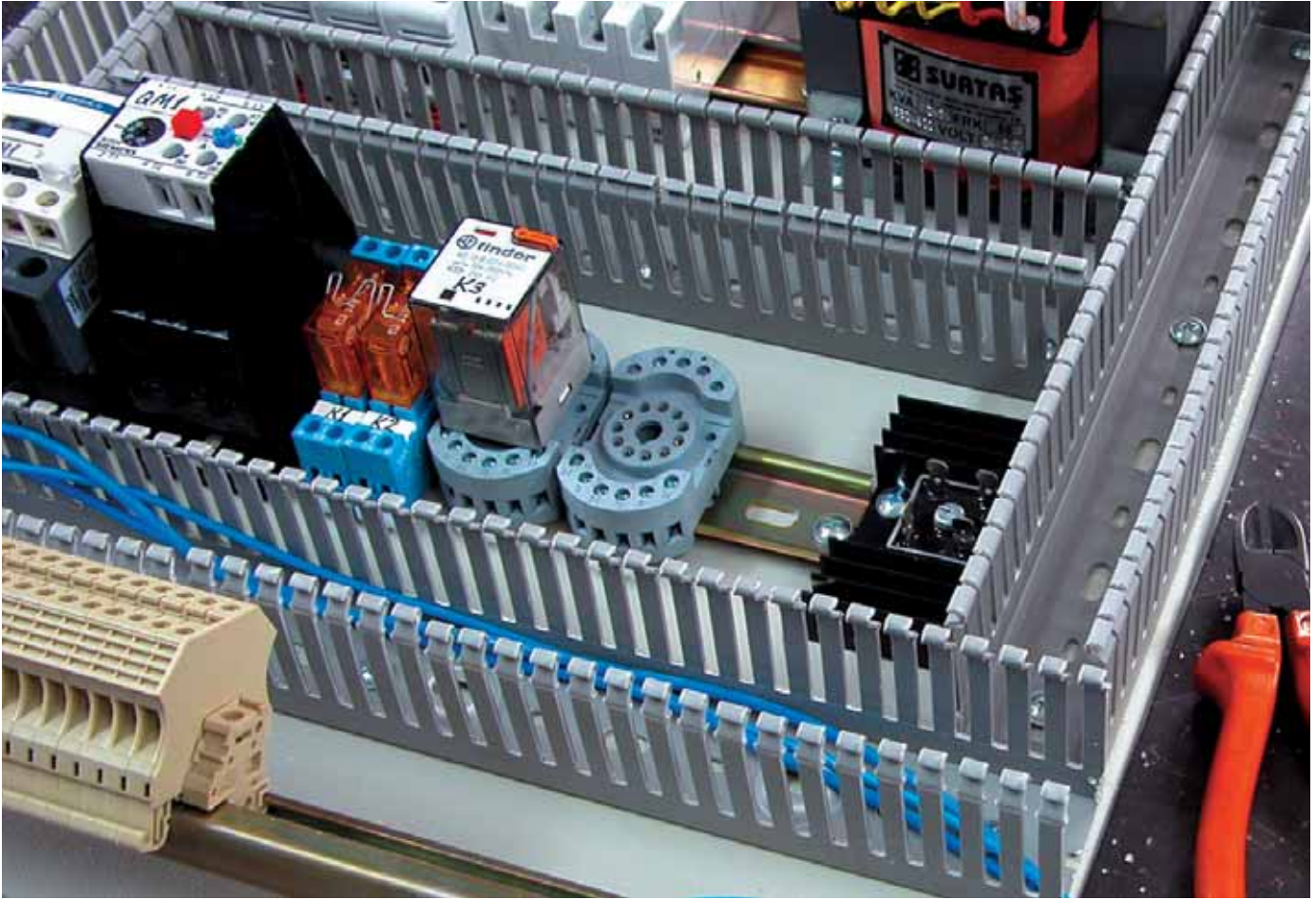

Kablo Tutucu Aparatı
Cable Holder Apparatus

		25x40	40x40	60x40
Ürün Kodu	Product Code	001 050 010001 00 00	001 050 010002 00 00	001 050 010003 00 00
Ambalaj Şekli	Packing Type	Kutu - Box	Kutu - Box	Kutu - Box
Adet / m	Quantity / m	- m	- m	- m
Ağırlık	Weight	- kg	- kg	- kg
m ³ /	Volume	-	-	-

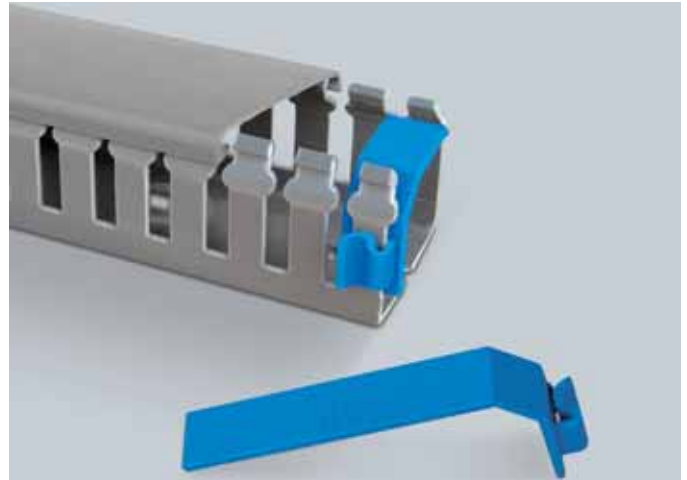

Kablo Tutucu Yan Aparatı
Cable Holder Side Apparatus

		40x40/60	60x40/60	80x60	100x60
Ürün Kodu	Product Code	001 050 020001 00 00	001 050 020002 00 00	001 050 020003 00 00	001 050 020004 00 00
Ambalaj Şekli	Packing Type	Kutu - Box	Kutu - Box	Kutu - Box	Kutu - Box
Adet / m	Quantity / m	- m	- m	- m	- m
Ağırlık	Weight	- kg	- kg	- kg	- kg
m ³ /	Volume	-	-	-	-

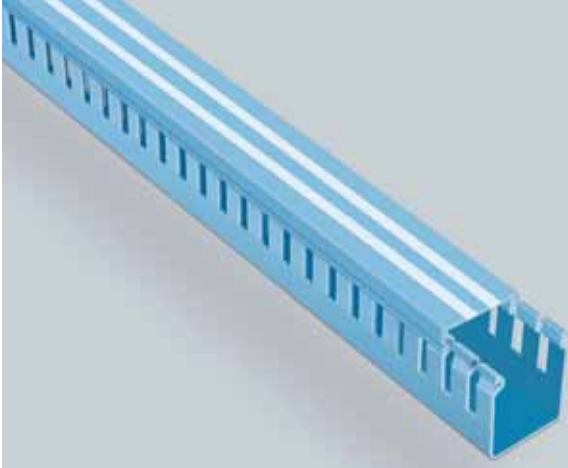
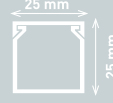
**25x25****Mavi**
Blue

Ürün Kodu	Product Code	001 005 025025 20 13
Ambalaj Şekli	Packing Type	Kutu - Box
Adet / m	Quantity / m	128 m
Ağırlık	Weight	26.865 kg
m ³ /	Volume	0.0992

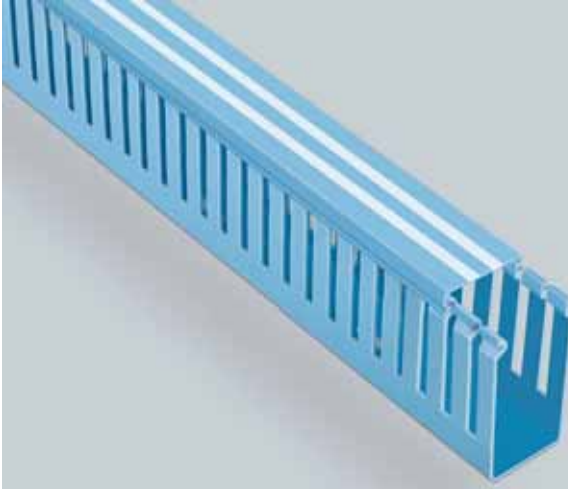
**25x40****Mavi**
Blue

Ürün Kodu	Product Code	001 005 025040 20 13
Ambalaj Şekli	Packing Type	Kutu - Box
Adet / m	Quantity / m	80 m
Ağırlık	Weight	23,665 kg
m ³ /	Volume	0.0992

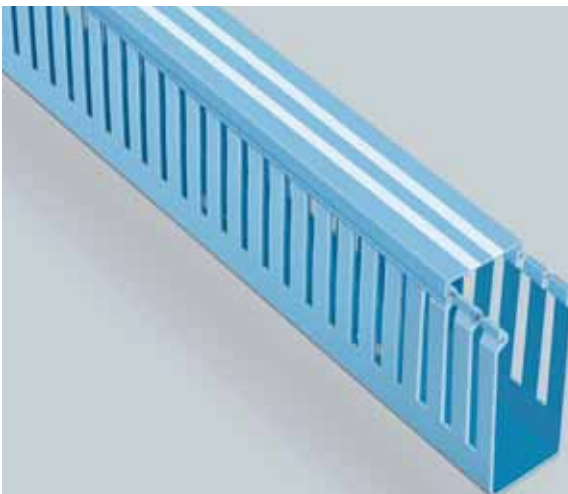
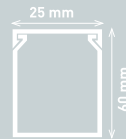
**25x60****Mavi**
Blue

Ürün Kodu	Product Code	001 005 025060 20 13
Ambalaj Şekli	Packing Type	Kutu - Box
Adet / m	Quantity / m	80 m
Ağırlık	Weight	33.51 kg
m ³ /	Volume	0.14392

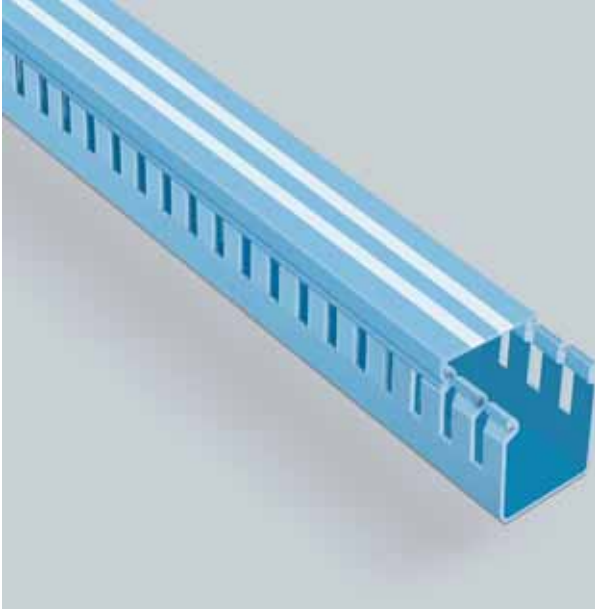
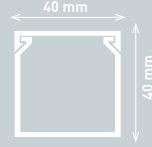
**40x40****Mavi**
Blue

Ürün Kodu	Product Code	001 005 040040 20 13
Ambalaj Şekli	Packing Type	Kutu - Box
Adet / m	Quantity / m	50 m
Ağırlık	Weight	18.765 kg
m ³ /	Volume	0.0992

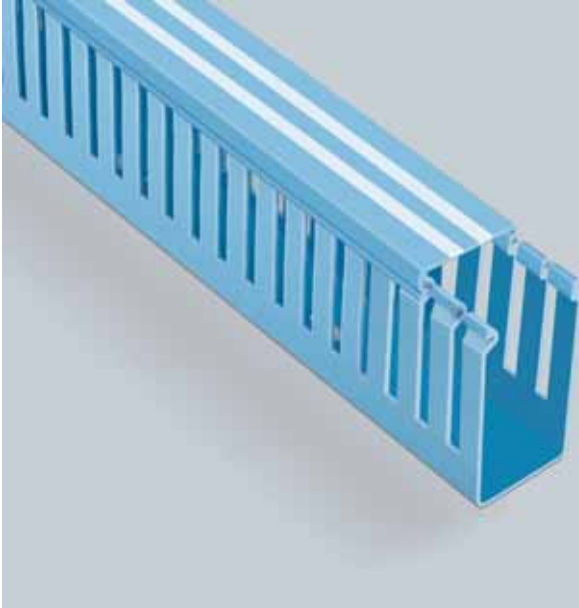
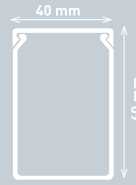
**40x60****Mavi**
Blue

Ürün Kodu	Product Code	001 005 040060 20 13
Ambalaj Şekli	Packing Type	Kutu - Box
Adet / m	Quantity / m	48 m
Ağırlık	Weight	23.11 kg
m ³ /	Volume	0.1439

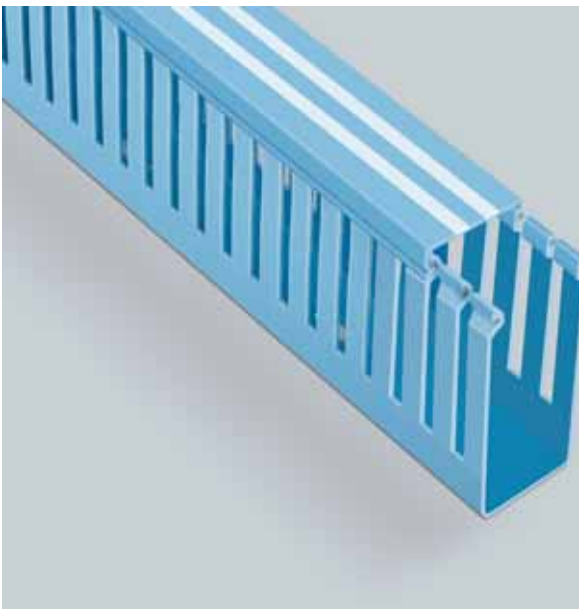
**40x80****Mavi**
Blue

Ürün Kodu	Product Code	001 005 040080 20 13
Ambalaj Şekli	Packing Type	Kutu - Box
Adet / m	Quantity / m	36 m
Ağırlık	Weight	20.23 kg
m ³ /	Volume	0.14393

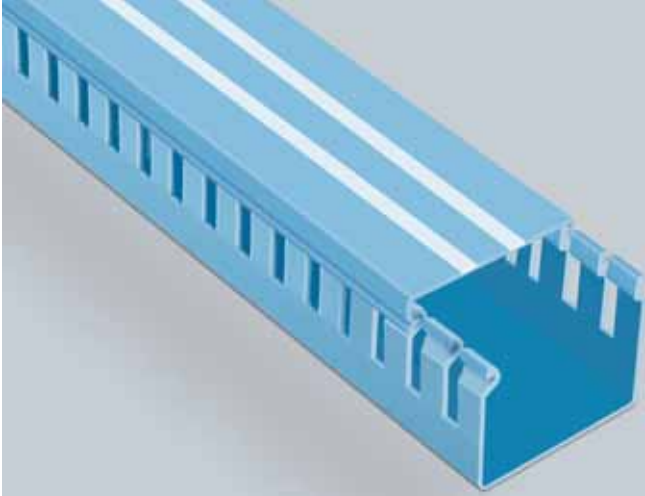
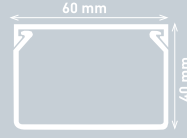
**60x40****Mavi**
Blue

Ürün Kodu	Product Code	001 005 060040 20 13
Ambalaj Şekli	Packing Type	Kutu - Box
Adet / m	Quantity / m	48 m
Ağırlık	Weight	25.51 kg
m ³ /	Volume	0.1439

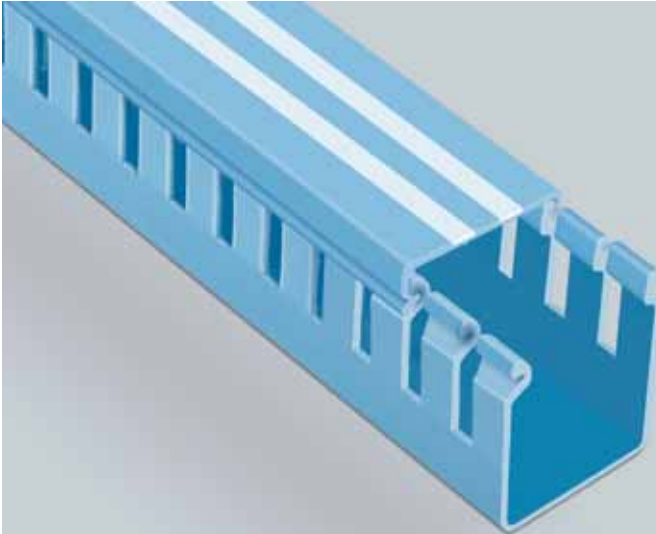
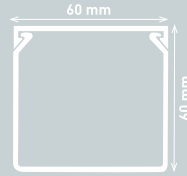
**60x60****Mavi**
Blue

Ürün Kodu	Product Code	001 005 060060 20 13
Ambalaj Şekli	Packing Type	Kutu - Box
Adet / m	Quantity / m	32 m
Ağırlık	Weight	19.11 kg
m ³ /	Volume	0.1439

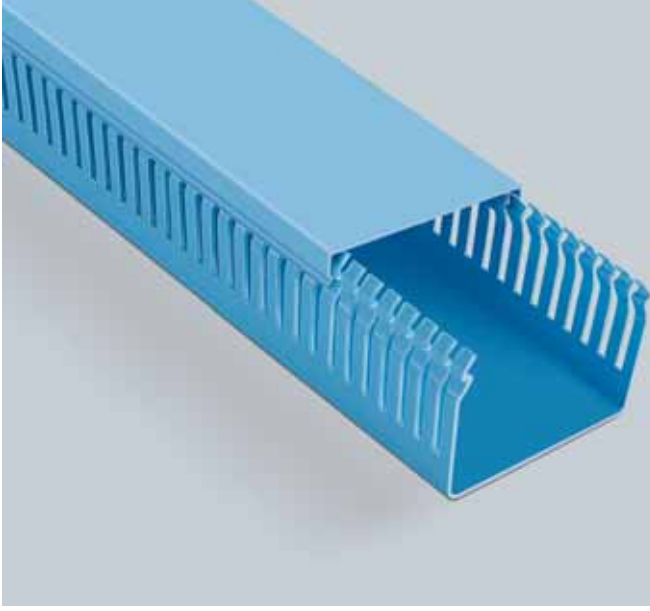
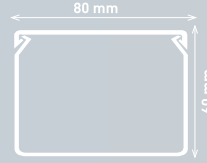

**80x60****Mavi**
Blue

Ürün Kodu	Product Code	001 005 080060 20 13
Ambalaj Şekli	Packing Type	Kutu - Box
Adet / m	Quantity / m	24 m
Ağırlık	Weight	16.63 kg
m ³ /	Volume	0.1439

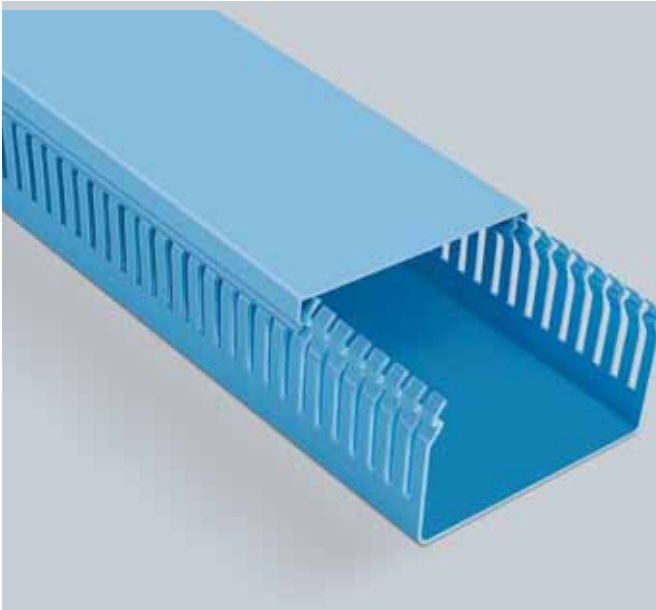
**100x60****Mavi**
Blue

Ürün Kodu	Product Code	001 005 100060 20 13
Ambalaj Şekli	Packing Type	Kutu - Box
Adet / m	Quantity / m	16 m
Ağırlık	Weight	14.31 kg
m ³ /	Volume	0.1439

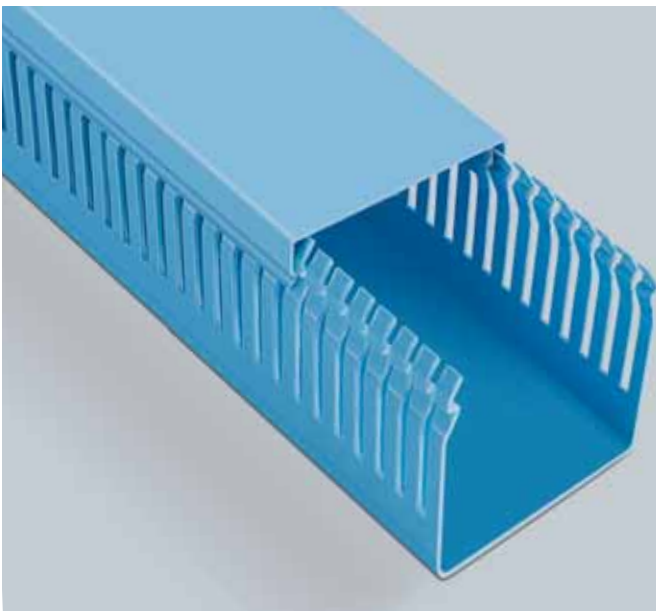
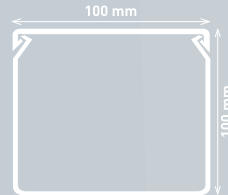
**100x100****Mavi**
Blue

Ürün Kodu	Product Code	001 005 100100 20 13
Ambalaj Şekli	Packing Type	Kutu - Box
Adet / m	Quantity / m	8 m
Ağırlık	Weight	10.55 kg
m ³ /	Volume	0.1439

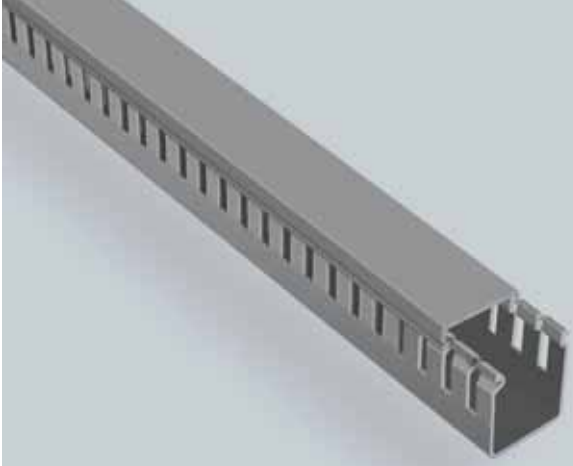
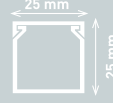
**25x25****Gri**
Grey

Ürün Kodu	Product Code	001 005 025025 20 17
Ambalaj Şekli	Packing Type	Kutu - Box
Adet / m	Quantity / m	128 m
Ağırlık	Weight	26.865 kg
m ³ /	Volume	0.0992

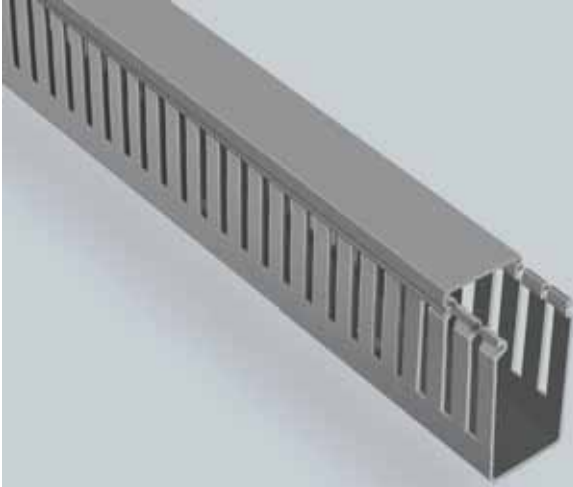
**25x40****Gri**
Grey

Ürün Kodu	Product Code	001 005 025040 20 17
Ambalaj Şekli	Packing Type	Kutu - Box
Adet / m	Quantity / m	80 m
Ağırlık	Weight	23,665 kg
m ³ /	Volume	0.0992

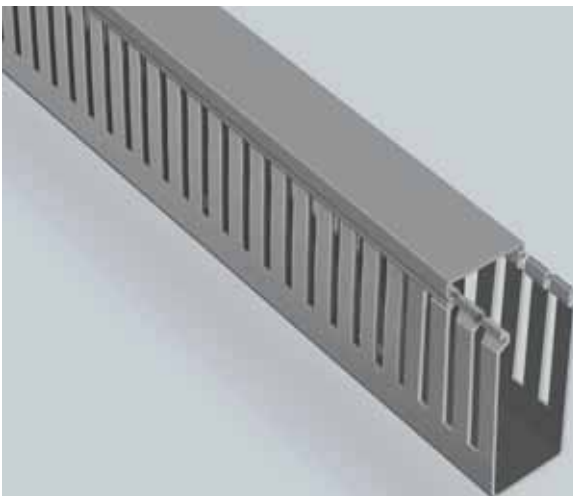
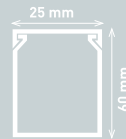
**25x60****Gri**
Grey

Ürün Kodu	Product Code	001 005 025060 20 17
Ambalaj Şekli	Packing Type	Kutu - Box
Adet / m	Quantity / m	80 m
Ağırlık	Weight	33.51 kg
m ³ /	Volume	0.14392

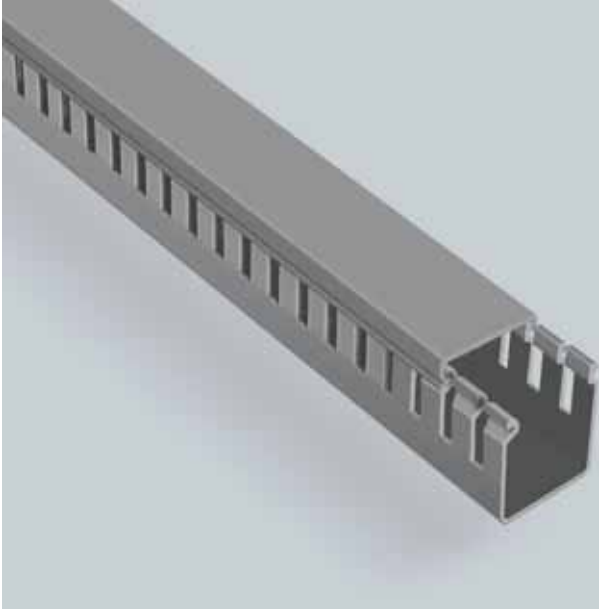
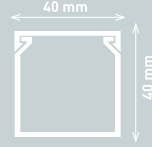
**40x40****Gri**
Grey

Ürün Kodu	Product Code	001 005 040040 20 17
Ambalaj Şekli	Packing Type	Kutu - Box
Adet / m	Quantity / m	50 m
Ağırlık	Weight	18.765 kg
m ³ /	Volume	0.0992

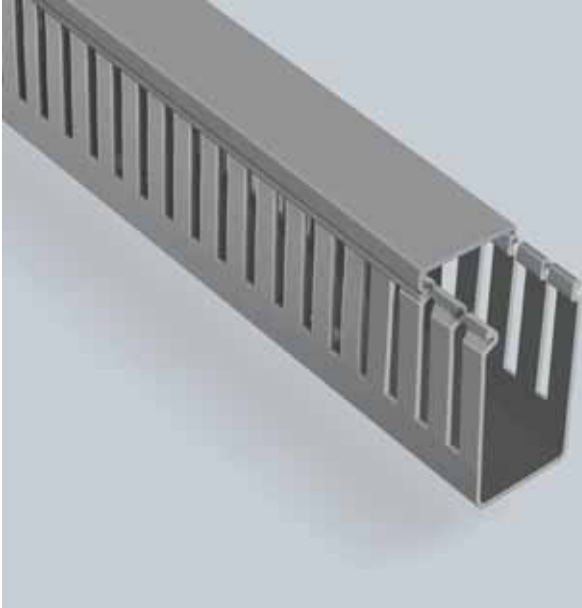
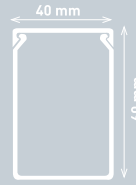
**40x60****Gri**
Grey

Ürün Kodu	Product Code	001 005 040060 20 17
Ambalaj Şekli	Packing Type	Kutu - Box
Adet / m	Quantity / m	48 m
Ağırlık	Weight	23.11 kg
m ³ /	Volume	0.1439

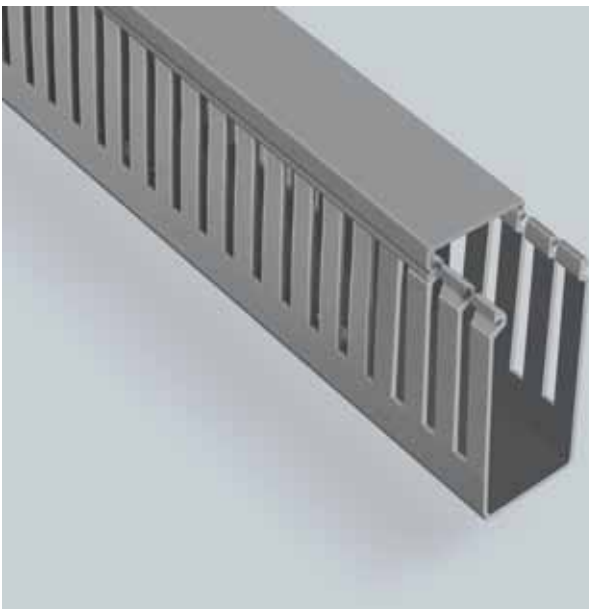
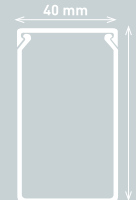
**40x80****Gri**
Grey

Ürün Kodu	Product Code	001 005 040080 20 17
Ambalaj Şekli	Packing Type	Kutu - Box
Adet / m	Quantity / m	36 m
Ağırlık	Weight	20.23 kg
m ³ /	Volume	0.14393

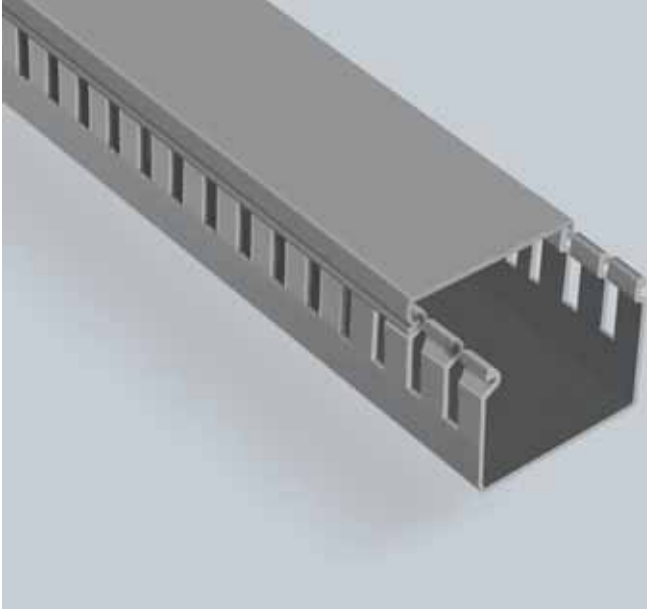
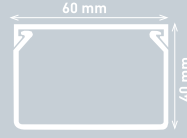
**60x40****Gri**
Grey

Ürün Kodu	Product Code	001 005 060040 20 17
Ambalaj Şekli	Packing Type	Kutu - Box
Adet / m	Quantity / m	48 m
Ağırlık	Weight	25.51 kg
m ³ /	Volume	0.1439

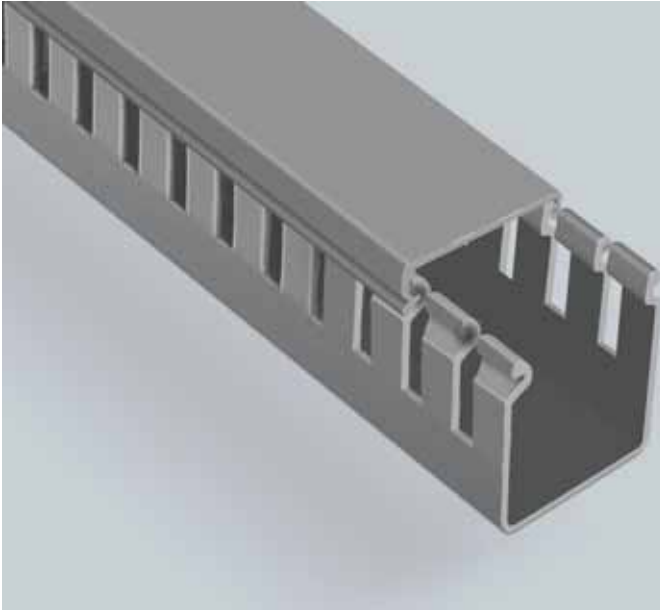
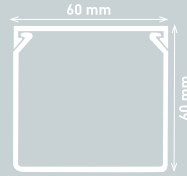
**60x60****Gri**
Grey

Ürün Kodu	Product Code	001 005 060060 20 17
Ambalaj Şekli	Packing Type	Kutu - Box
Adet / m	Quantity / m	32 m
Ağırlık	Weight	19.11 kg
m ³ /	Volume	0.1439

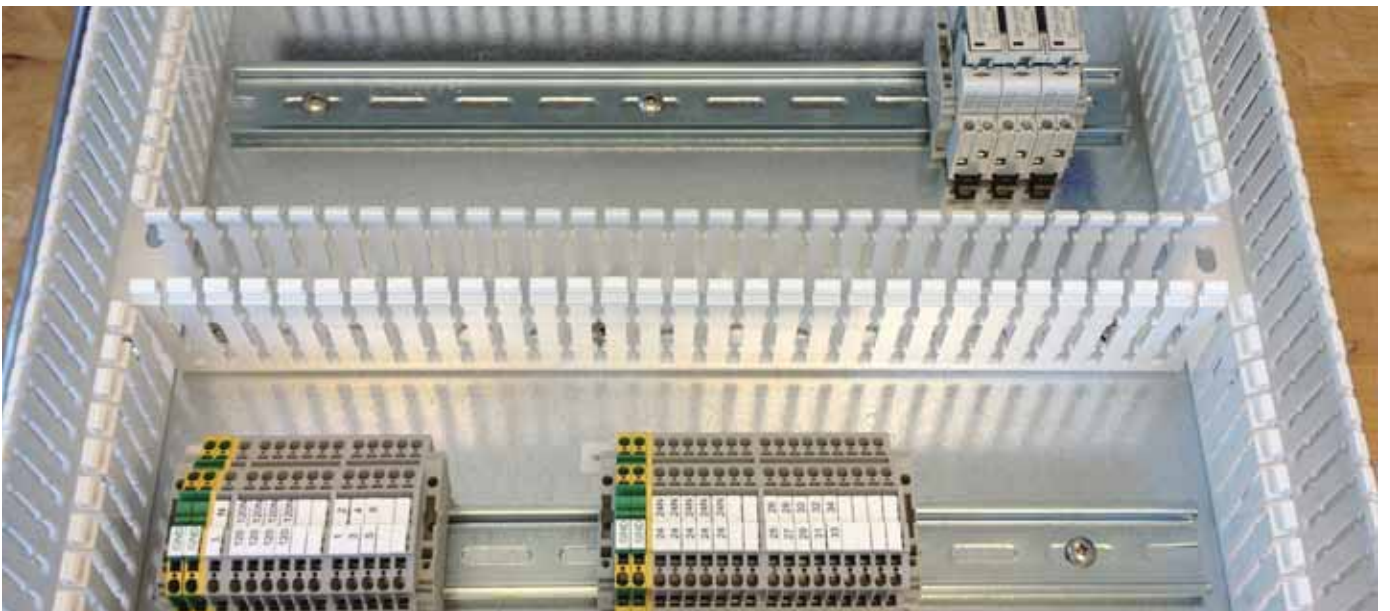

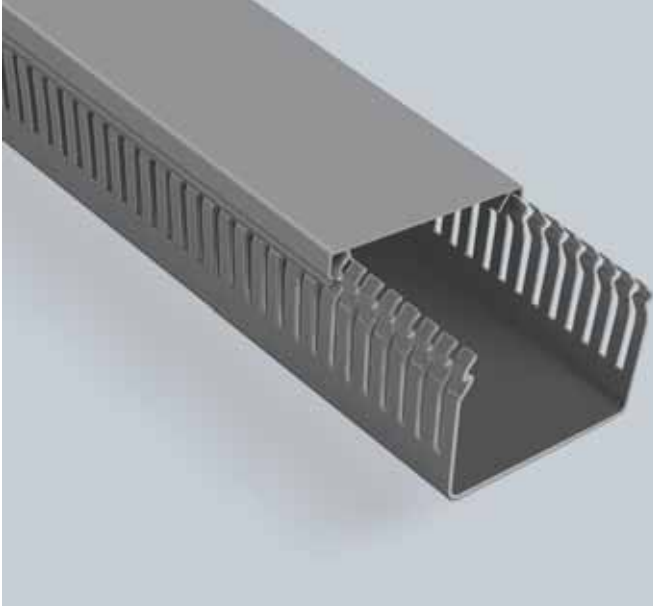
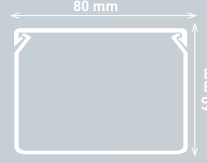
**80x60****Gri**
Grey

Ürün Kodu	Product Code	001 005 080060 20 17
Ambalaj Şekli	Packing Type	Kutu - Box
Adet / m	Quantity / m	24 m
Ağırlık	Weight	16.63 kg
m ³ /	Volume	0.1439

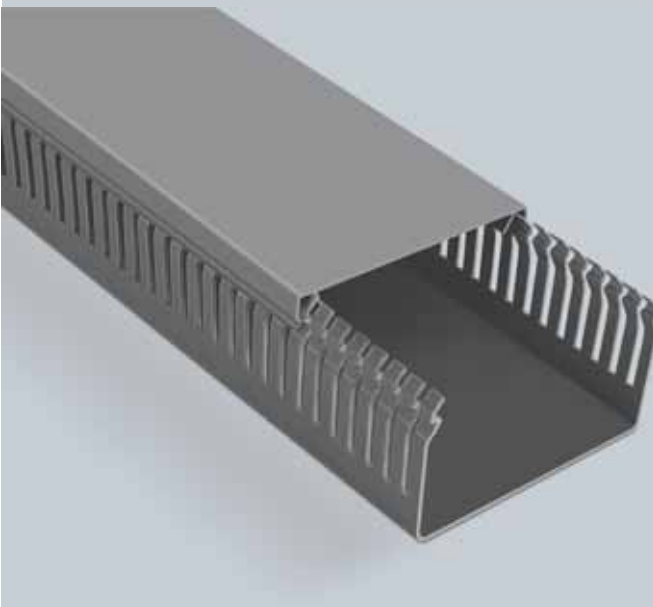
**100x60****Gri**
Grey

Ürün Kodu	Product Code	001 005 100060 20 17
Ambalaj Şekli	Packing Type	Kutu - Box
Adet / m	Quantity / m	16 m
Ağırlık	Weight	14.31 kg
m ³ /	Volume	0.1439

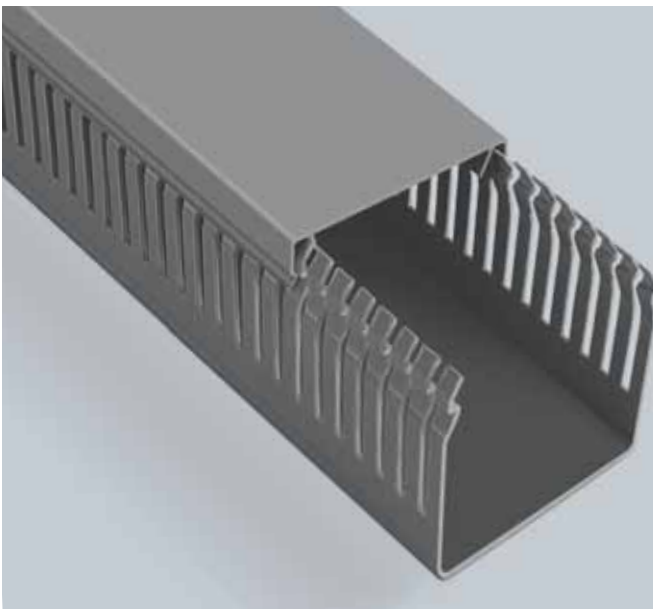
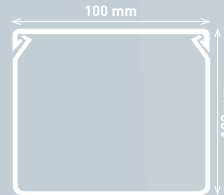
**100x100****Gri**
Grey

Ürün Kodu	Product Code	001 005 100100 20 17
Ambalaj Şekli	Packing Type	Kutu - Box
Adet / m	Quantity / m	8 m
Ağırlık	Weight	10.55 kg
m ³ /	Volume	0.1439

OTOMASYON

AUTOMATION



SANAYİ FİŞ - PRİZ GRUBU

PLUG - SOCKET GROUP

1x16A MONOFAZE	Kod Code	Açıklama Description	Ambalaj Packing	Adet Quantity	Ağırlık Weight	Hacim Volume
	010 083 300028	MUT-28 1x16 A. MONOFAZE TOPRAKLI ERKEK FİŞ (DÜZ) 1x16 A. MON.PHASE EARTHED PLUG	Kutu Pack	50	3.355 Kg	7.5
	010 083 300029	MUT-29 1x16 A. MONOFAZE TOPRAKLI DIŞI FİŞ 1x16 A. MON.PHASE EARTHED SOCKET	Kutu Pack	30	3.655 Kg	7.5
	010 083 500296	MUT-296 1x16 A. MONOFAZE TOPRAKLI DUVAR PRİZİ 1x16 A. MON.PHASE EARTHED WALL SOCKET	Kutu Pack	24	3.355 Kg	7.5
	010 083 500292	MUT-292 1x16 A. MONOFAZE 2'Lİ TOPRAKLI GRUP RİZ 1x16 A. MON.PHASE 2 GANG EARTHED GROUP SOCKET	Kutu Pack	12	3.850 Kg	7.5
	010 083 501292	MUT-292A 1x16 A. MONOFAZE 2'Lİ TOPRAKLI GRUP PRİZ ANAHTARLI 1x16 A. MON.PHASE 2 GANG EARTHED GROUP SOCKET (WITH SWITCH)	Kutu Pack	12	3.900 Kg	7.5
	010 083 500293	MUT-293 1x16 A. MONOFAZE 3'LÜ TOPRAKLI GRUP RİZ 1x16 A. MON.PHASE 3 GANG EARTHED GROUP SOCKET	Kutu Pack	10	4.110 Kg	7.5
	010 083 500298	MUT-298 MONOFAZE TOPRAKLI PANO PRİZİ MON.PHASE EARTHED PANEL SOCKET	Kutu Pack	40	2.160 Kg	7.5
	010 083 501297	MUT-298U MONOFAZE UPS TOPRAKLI PANO PRİZİ MON.PHASE EARTHED UPS PANEL SOCKET	Kutu Pack	40	2.200 Kg	7.5

SANAYİ FİŞ - PRİZ GRUBU

PLUG - SOCKET GROUP

1x16A MONOFAZE	Kod Code	Açıklama Description	Ambalaj Packing	Adet Quantity	Ağırlık Weight	Hacim Volume
	010 083 500297	MUT-297 MONOFAZE DUVAR PRİZİ (PLASTİK) MON.PHASE WALL SOCKET (PLASTIC)	Kutu Pack	30	2.000 Kg	7.5
	010 083 500299	MUT-299 MONOFAZE MAKİNA PRİZİ MON.PHASE AUTOMATION SOCKET	Kutu Pack	20	2.400 Kg	7.5
	010 083 502910	MUT-2910 MONOFAZE DUVAR PRİZİ MON.PHASE WALL SOCKET	Kutu Pack	15	2.650 Kg	7.5
3x16A TRİFAZE	Kod Code	Açıklama Description	Ambalaj Packing	Adet Quantity	Ağırlık Weight	Hacim Volume
	010 083 400060	MUT-60 3x16 A. TRİFAZE ERKEK FİŞ 3x16 A. THREE PHASE PLUG	Kutu Pack	30	3.700 Kg	7.5
	010 083 400061	MUT-61 3x16 A. TRİFAZE SEYYAR DIŞI FİŞ 3x16 A. THREE PHASE PORTABLE SOCKET	Kutu Pack	25	4.500 Kg	7.5
	010 083 400062	MUT-62 3x16 A. TRİFAZE DUVAR PRİZİ 3x16 A. THREE PHASE WALL SOCKET	Kutu Pack	20	4.600 Kg	7.5
	010 083 400063	MUT-63 3x16 A. TRİFAZE DUVAR PRİZİ (PLASTİK) 3x16 A. THREE PHASE WALL SOCKET (PLASTIC)	Kutu Pack	12	2.750 Kg	7.5
	010 083 400064	MUT-64 3x16 A. TRİFAZE MAKİNA PRİZİ (PLASTİK) 3x16 A. THREE PHASE AUTOMATION SOCKET (PLASTIC)	Kutu Pack	20	2.500 Kg	7.5

SANAYİ FİŞ - PRİZ GRUBU

PLUG - SOCKET GROUP

3x25A TRİFAZE	Kod Code	Açıklama Description	Ambalaj Packing	Adet Quantity	Ağırlık Weight	Hacim Volume
	010 083 400030	MUT-30 3x25 A. TRİFAZE ERKEK FİŞ 3x25 A. THREE PHASE PLUG	Kutu Pack	30	3.250 Kg	7.5
	010 083 400031	MUT-31 3x25 A. TRİFAZE SEYAR DİŞİ FİŞ 3x25 A. THREE PHASE PORTABLE SOCKET	Kutu Pack	25	4.605 Kg	7.5
	010 083 600315	MUT-315 3x25 A. TRİFAZE DUVAR PRİZİ 3x25 A. THREE PHASE WALL SOCKET	Kutu Pack	24	4.800 Kg	7.5
	010 083 400319	MUT-19 3x25 A. TRİFAZE DUVAR PRİZİ (PLASTİK) 3x25 A. THREE PHASE WALL SOCKET (PLASTIC)	Kutu Pack	15	3.000 Kg	7.5
	010 083 400318	MUT-318 3x25 A. TRİFAZE MAKİNA PRİZİ (PLASTİK) 3x25 A. THREE PHASE AUTOMATION SOCKET (PLASTIC)	Kutu Pack	20	2.500 Kg	7.5
	010 083 600311	MUT-311 1 TRİFAZE + 1 MONOFAZE 2'Lİ GRUP PRİZ 1 THREE PHASE + 1 MON.PHASE 2 GANG GROUP SOCKET	Kutu Pack	10	3.650 Kg	7.5
	010 083 600312	MUT-312 TRİFAZE 2'Lİ GRUP PRİZ THREE PHASE 2 GANG GROUP SOCKET	Kutu Pack	10	3.750 Kg	7.5
	010 083 600313	MUT-313 TRİFAZE 3'LÜ GRUP PRİZ THREE PHASE 3 GANG GROUP SOCKET	Kutu Pack	8	4.160 Kg	7.5





SANAYİ FİŞ - PRİZ GRUBU

PLUG - SOCKET GROUP

1x16A MONOFAZE	Kod Code	Açıklama Description	Ambalaj Packing	Adet Quantity	Ağırlık Weight	Hacim Volume
	010 083 600316	MUT-316 2 TRİFAZE + 1 MONOFAZE 3'LÜ GRUP PRİZ 2 THREE PHASE + 1 MON.PHASE 3 GANG GROUP SOCKET	Kutu Pack	8	3.950 Kg	7.5
	010 083 600317	MUT-317 1 TRİFAZE + 2 MONOFAZE 3'LÜ GRUP PRİZ 1 THREE PHASE + 2 MON.PHASE 3 GANG GROUP SOCKET	Kutu Pack	8	3.750 Kg	7.5
3x32A TRİFAZE	Kod Code	Açıklama Description	Ambalaj Packing	Adet Quantity	Ağırlık Weight	Hacim Volume
	010 083 400070	MUT-70 3x32 A. TRİFAZE ERKEK FİŞ 3x32 A. THREE PHASE PLUG	Kutu Pack	20	4.650 Kg	7.5
	010 083 400071	MUT-71 3x32 A. TRİFAZE SEYYAR DİŞİ FİŞ 3x32 A. THREE PHASE PORTABLE SOCKET	Kutu Pack	20	4.800 Kg	7.5
	010 083 400072	MUT-72 3x32 A. TRİFAZE DUVAR PRİZİ 3x32 A. THREE PHASE WALL SOCKET	Kutu Pack	20	4.800 Kg	7.5
	010 083 400073	MUT-73 3x32 A. TRİFAZE DUVAR PRİZİ (PLASTİK) 3x32 A. THREE PHASE WALL SOCKET (PLASTIC)	Kutu Pack	12	2.750 Kg	7.5
	010 083 400074	MUT-374 3x32 A. TRİFAZE MAKİNA PRİZİ (PLASTİK) 3x32 A. THREE PHASE AUTOMATION SOCKET (PLASTIC)	Kutu Pack	20	2.500 Kg	7.5

SİNYAL VE KUMANDA BUTONLARI

SIGNAL AND CONTROL BUTTONS

	Kod Code	Açıklama Description	Ambalaj Packing	Adet Quantity	Ağırlık Weight	Hacim Volume	Renk Color
	010 090 010001	10mm Sinyal Armatürü 10mm Signal Luminaire Neon Lamp - 220V Silikon Kablo / Silicon Cable	Kutu Pack	100	0.30 Kg	0.001	<ul style="list-style-type: none"> ● Kırmızı / Red ● Yeşil / Green ● Sarı / Yellow ● Mavi / Blue ● Beyaz / White
	010 090 010005	14mm Sinyal Armatürü 14mm Signal Luminaire 12 V - Neon Lamp	Kutu Pack	50	0.340 Kg	0.001	<ul style="list-style-type: none"> ● Kırmızı / Red ● Yeşil / Green ● Sarı / Yellow ● Mavi / Blue ● Beyaz / White
	010 090 010006	24 V					
	010 090 010007	220 V					
	010 090 010008	22mm Sinyal Armatürü 22mm Signal Luminaire 12 V - Neon Lamp	Kutu Pack	24	0.46 Kg	0.001	<ul style="list-style-type: none"> ● Kırmızı / Red ● Yeşil / Green ● Sarı / Yellow ● Mavi / Blue ● Beyaz / White
	010 090 010009	24 V					
	010 090 010010	220 V					
	010 090 010002	Ba9s Duylu Ledli 22mm Sinyal Armatürü (24V-220V) 22 mm Ba9s Signal Luminaire with lamp base and LED light (24V-220V)	Kutu Pack	24	0.55 Kg	0.001	<ul style="list-style-type: none"> ● Kırmızı / Red ● Yeşil / Green ● Sarı / Yellow ● Mavi / Blue ● Beyaz / White
	010 090 010003	Ba9s Duylu Neon 22mm Sinyal Armatürü (24V-220V) 22 mm Ba9s Signal Luminaire with lamp base and Neon light (24V-220V)					
	010 111 070002	Led'li Buzzer Buzzer with LED 24 V	Kutu Pack	-	-	-	
	010 111 070001	220 V					
	010 111 070004	Buzzer Buzzer 24 V					
	010 111 070003	220 V					
	010 090 010004	Ba9s Duylu Ledli Işık Soketli Adaptörlü 22mm Sinyal Armatürü 22 mm Ba9s Signal Luminaire with lamp base, LED light socket	Kutu Pack	20	0.60 Kg	0.002	<ul style="list-style-type: none"> ● Kırmızı / Red ● Yeşil / Green ● Sarı / Yellow ● Mavi / Blue ● Beyaz / White
	010 090 040001	Yaylı Start Butonu Spring Start Button	Kutu Pack	20	0.56 Kg	0.002	<ul style="list-style-type: none"> ● Yeşil / Green ● Sarı / Yellow ● Mavi / Blue ● Beyaz / White
	010 090 040002	Yaylı Stop Butonu Spring Start Button					

SİNYAL VE KUMANDA BUTONLARI

SIGNAL AND CONTROL BUTTONS

	Açıklama Description	Kontakt Contact	Devre Circuit	Ambalaj Packing	Adet Quantity	Ağırlık Weight	Hacim Volume	Renk Color
	Ba9s Neon Ampüllü Yaylı Işıklı Start Butonu Ba9s Illuminated Spring Loaded Start Button with Neon Lamp	1 N / A 1 N/O		Kutu Pack	20	0.80 Kg	0.003	● Yeşil / Green ● Sarı / Yellow ● Mavi / Blue ● Beyaz / White
	Ba9s Neon Ampüllü Yaylı Işıklı Stop Butonu Ba9s Illuminated Spring Loaded Stop Button with Neon Lamp	1 N / A 1 N/O		Kutu Pack	20	0.82 Kg	0.002	● Kırmızı / Red
	Ba9s Ledli Yaylı Işıklı Start Butonu Ba9s Illuminated Spring Loaded Start Button with LED	1 N / A 1 N/O		Kutu Pack	20	0.80 Kg	0.001	● Yeşil / Green ● Sarı / Yellow ● Mavi / Blue ● Beyaz / White
	Ba9s Ledli Yaylı Işıklı Stop Butonu Ba9s Illuminated Spring Loaded Stop Button with LED	1 N / A 1 N/O		Kutu Pack	20	0.80 Kg	0.001	
	Yaylı Mantar Kafa Buton Start Spring Loaded Mushroom Shaped Start Button			Kutu Pack	12	0.53 Kg	0.001	● Yeşil / Green
	Yaylı Mantar Kafa Buton Stop Spring Loaded Mushroom Shaped Stop Button				12	0.54 Kg	0.001	● Siyah / Black ● Kırmızı / Red
	Ba9s Ledli Işıklı Seçici Buton 0-1 Ba9s Illuminated Selector Button with LED 0-1			Kutu Pack	12	0.52 Kg	0.001	● Yeşil / Green
	Ba9s Ledli Işıklı Seçici Buton 11-0-1 Ba9s Illuminated Spring Loaded Stop Button with LED 11-0-1				12	0.60Kg	0.001	● Yeşil / Green
	Eski Tip Start-Stop Butonu Çift Kontak Vintage Start-Stop Button Double Contact			Kutu Pack	20	0.80 Kg	0.002	● Kırmızı / Red ● Yeşil / Green ● Sarı / Yellow ● Mavi / Blue ● Beyaz / White

SİNYAL VE KUMANDA BUTONLARI

SIGNAL AND CONTROL BUTTONS

	Açıklama Description	Kontakt Contact	Devre Circuit	Ambalaj Packing	Adet Quantity	Ağırlık Weight	Hacim Volume	Renk Color
 010 090 020001	Eski Tip Start Butonu Tek Kontakt Vintage Start Button Single Contact			Kutu Pack	20	0.80 Kg	0.002	<ul style="list-style-type: none"> ● Yeşil / Green ● Sarı / Yellow ● Mavi / Blue ● Beyaz / White
 010 090 020003	Eski Tip Stop Butonu Tek Kontakt Vintage Stop Button Single Contact			Kutu Pack	20	0.70 Kg	0.002	<ul style="list-style-type: none"> ● Kırmızı / Red
 010 090 050001	Acil Stop Butonu Emergency Stop Button Ø30	1 N / K 1 N / C		Kutu Pack	12	0.50 Kg	0.001	<ul style="list-style-type: none"> ● Kırmızı / Red
 010 090 050002	Acil Stop Butonu Emergency Stop Button Ø40			Kutu Pack	12	0.54 Kg	0.001	<ul style="list-style-type: none"> ● Kırmızı / Red
 010 090 050007	Anahtarlı Acil Stop Butonu Emergency Stop Button with key Ø40	1 N / K 1 N / C		Kutu Pack	12	0.88 Kg	0.001	<ul style="list-style-type: none"> ● Kırmızı / Red
 010 090 040007	Yaylı İkiz Buton Spring-Loaded Double Button	1 N / A 1 N / 0 1 N / K 1 N / C		Kutu Pack	14	0.59 Kg	0.002	<ul style="list-style-type: none"> ● Kırmızı / Red ● Yeşil / Green

SİNYAL VE KUMANDA BUTONLARI

SIGNAL AND CONTROL BUTTONS

	Açıklama Description	Kontakt Contact	Devre Circuit	Ambalaj Packing	Adet Quantity	Ağırlık Weight	Hacim Volume	Renk Color
	Yaylı Işıklı İkiz Buton Spring-Loaded Illuminated Double Button	1 N / A 1 N / O 1 N / K 1 N / C	$\begin{array}{ c} 4 \\ \hline 2 \\ \hline 3 \\ \hline 1 \end{array}$	Kutu Pack	14	0.56 Kg	0.001	● Kırmızı / Red ● Yeşil / Green
010 090 040006								
	Seçici Buton Selector Button O-I O-I	1 N / A 1 N / O	$\begin{array}{ c} 4 \\ \hline 3 \end{array}$	Kutu Pack	12	0.39 Kg	0.001	● Siyah / Black
010 090 030001								
	Anahtarlı Seçici Buton Selector Button with Key O-I O-I	1 N / A 1 N / O	$\begin{array}{ c} 4 \\ \hline 3 \end{array}$	Kutu Pack	12	0.65 Kg	0.001	● Siyah / Black
010 090 030007								
	Seçici Buton Selector Button II-O-I II-O-I	2 N / A 2 N / O	$\begin{array}{ c} 4 \\ \hline 3 \end{array}$	Kutu Pack	12	0.52 Kg	0.001	● Siyah / Black
010 090 030002								
	Anahtarlı Seçici Buton Selector Button with Key II-O-I II-O-I	2 N / A 2 N / O	$\begin{array}{ c} 4 \\ \hline 3 \end{array}$	Kutu Pack	12	0.77 Kg	0.001	● Siyah / Black
010 090 030008								
	Ba9s Neon Ampullü Işıklı Seçici Buton Illuminated Selector Button with Ba9s Neon Lamp O-I O-I	1 N / A 1 N / O	$\begin{array}{ c} 4 \text{ } \circ \text{ X1} \\ \hline \text{ } \circ \text{ X2} \\ \hline 3 \end{array}$	Kutu Pack	12	0.52 Kg	0.001	● Yeşil / Green
010 090 030005								

SİNYAL VE KUMANDA BUTONLARI

SIGNAL AND CONTROL BUTTONS

	Açıklama Description	Kontakt Contact	Devre Circuit	Ambalaj Packing	Adet Quantity	Ağırlık Weight	Hacim Volume	Renk Color
 010 090 030006	Işıklı Seçici Buton Illuminated Selector Button II-O-I II-Ö-I	2 N / A 2 N / O		Kutu Pack	12	0.62 Kg	0.001	● Yeşil / Green
 010 091 020002	Yön İşaretili Start Butonu Start Button With Direction Marker			Kutu Pack	20	0.58 Kg	0.002	
 010 093 000003	Acil Durdurma Etiket Emergency Stop Tag Ø60mm			Kutu Pack	50	0.07 Kg	0.0001	● Sarı / Yellow
 010 093 000001	Silikon Toz Kılıfı Silicon Dustsheet			Kutu Pack	50	0.10 Kg	0.001	● Şeffaf / Lens
 010 090 050008	Emniyet Basma Düğmesi Muhafazası Safety Push Button Housing			Kutu Pack	50	0.23 Kg	0.002	● Sarı / Yellow
 010 093 000002	Buton Etiket Button Tag			Kutu Pack	50	0.08Kg	0.004	● Siyah / Black
 010 093 000004	Yedek Kontakt Blok Reserve Contact Block			Kutu Pack	50	0.55 Kg	0.002	● Kırmızı / Red ● Yeşil / Green
 010 093 000005	Işık Soketi Light Socket			Kutu Pack	50	0.47 Kg	0.002	

ETANJ BUTON KUTULARI

WATERPROOF BUTTON BOXES

	Açıklama Description	Ambalaj Packing	Adet Quantity	Ağırlık Weight	Hacim Volume	Renk Color
 010 091 010001	1'li Etanj Buton Kutusu Water Proof Button Box, Single (New Model) Ø 22mm IP 54 Ø 25mm	Kutu Pack	24	1.99 Kg	0.008	 Sarı-Siyah / Yellow-Black  Gri-Siyah / Grey-Black
 010 091 010002	2'li Etanj Buton Kutusu Water Proof Button Box, Double (New Model) Ø 22mm IP 54 Ø 25mm	Kutu Pack	16	1.94 Kg	0.008	 Sarı-Siyah / Yellow-Black  Gri-Siyah / Grey-Black
 010 091 010003	3'lü Etanj Buton Kutusu Water Proof Button Box, Triple (New Model) Ø 22mm IP 54 Ø 25mm	Kutu Pack	8	1.30 Kg	0.007	 Sarı-Siyah / Yellow-Black  Gri-Siyah / Grey-Black
 010 091 010004	4'lü Etanj Buton Kutusu Water Proof Button Box, Quadruple (New Model) Ø 22mm IP 54 Ø 25mm	Kutu Pack	8	1.50 Kg	0.007	 Sarı-Siyah / Yellow-Black  Gri-Siyah / Grey-Black
 010 091 020001	Asansör Revizyon Kutusu Elevator Revision Box	Kutu Pack	6	1.94 Kg	0.007	 Sarı-Siyah / Yellow-Black  Gri-Siyah / Grey-Black
 010 090 050009	Tekli Acil Stoplu Kutu Box Emergency Stop, Single	Kutu Pack	18	2.25 Kg	0.007	 Sarı-Siyah / Yellow-Black  Gri-Siyah / Grey-Black

VİNÇ KUMANDA BUTONLARI

CRANE CONTROL BUTTONS

	Açıklama Description	Kontakt Contact	Ambalaj Packing	Adet Quantity	Ağırlık Weight	Hacim Volume
 010 092 000001	2'li Vinç Kutusu (Tek Hızlı) Crane Box, Double (Single Speed) IP 65	1 N / A 1 N / 0 1 N / K 1 N / C	Kutu Pack	1	0.53 Kg	0.003
 010 092 000002	3'lü Vinç Kutusu (Tek Hızlı) Crane Box, Triple (Single Speed) IP 65	1 N / A 1 N / 0 1 N / K 1 N / C	Kutu Pack	1	0.56 Kg	0.003
 010 092 000003	4'lü Vinç Kutusu (Tek Hızlı) Crane Box, Quadruple (Single Speed) IP 65	1 N / A 1 N / 0 1 N / K 1 N / C	Kutu Pack	1	0.66 Kg	0.003
 010 092 000004	5'li Vinç Kutusu (Tek Hızlı) Crane Box, Quintet (Single Speed) IP 65	1 N / A 1 N / 0 1 N / K 1 N / C	Kutu Pack	1	0.66 Kg	0.003
 010 092 000005	6'li Vinç Kutusu (Tek Hızlı) Crane Box, Sextet (Single Speed) IP 65	1 N / A 1 N / 0 1 N / K 1 N / C	Kutu Pack	1	0.81 Kg	0.003
 010 092 000006	7'li Vinç Kutusu (Tek Hızlı) Crane Box, Septet (Single Speed) IP 65	1 N / A 1 N / 0 1 N / K 1 N / C	Kutu Pack	1	0.88 Kg	0.003







SÜPER ETANJ RAKORLAR

SUPER WATERPROOF CABLE GLANDS

	Kod Code	Açıklama Description	Kablo Çapı (min.-max.) Cable Diameter (min.-max.)	Ambalaj Packing	Adet Quantity	Ağırlık Weight	Hacim Volume
	010 097 000007	PG-7	3,0 mm - 6,5 mm	Kutu Pack	450	2.48 Kg	0.007
	010 097 000009	PG-9	4,0 mm - 8,0 mm	Kutu Pack	300	2.10 Kg	0.006
	010 097 000011	PG-11	5,0 mm - 10,0 mm	Kutu Pack	200	2 Kg	0.006
	010 097 000135	PG-13,5	6,0 mm - 12,0 mm	Kutu Pack	175	2.10 Kg	0.006
	010 097 000016	PG-16	10,0 mm - 14,0 mm	Kutu Pack	125	2.03 Kg	0.006
	010 097 000021	PG-21	13,0 mm - 18,0 mm	Kutu Pack	75	1.73 Kg	0.006
	010 097 000029	PG-29	18,0 mm - 25,0 mm	Kutu Pack	40	1.68 Kg	0.006
	010 097 000036	PG-36	22,0 mm - 32,0 mm	Kutu Pack	20	1.60 Kg	0.006
	010 097 000042	PG-42	32,0 mm - 38,0 mm	Kutu Pack	15	1.40 Kg	0.006
	010 097 000048	PG-48	34,0 mm - 44,0 mm	Kutu Pack	12	1.36 Kg	0.006



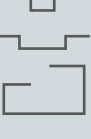

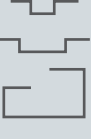

RAY KLEMENSLER

RAIL TERMINAL BLOCKS

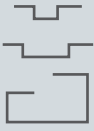

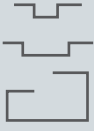

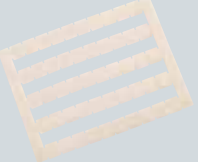





	Açıklama Description	Devre Circuit	Ambalaj Packing	Adet Quantity	Ağırlık Weight	Hacim Volume	Renk Color
 010 094 000025	2.5mm² Ray Klemens 2.5mm ² Rail Terminal Blocks Polyamid 66 Polyamide 66		Kutu Pack	100	0.75 Kg	0.002	<ul style="list-style-type: none"> ● Kırmızı / Red ● Yeşil / Green ● Sarı / Yellow ● Mavi / Blue ● Gri / Grey ● Siyah / Black
 010 094 000004	4mm² Ray Klemens 4mm ² Rail Terminal Blocks Polyamid 66 Polyamide 66		Kutu Pack	100	1.40 Kg	0.002	<ul style="list-style-type: none"> ● Kırmızı / Red ● Yeşil / Green ● Sarı / Yellow ● Mavi / Blue ● Gri / Grey ● Siyah / Black
 010 094 000006	6mm² Ray Klemens 6mm ² Rail Terminal Blocks Polyamid 66 Polyamide 66		Kutu Pack	100	1.60 Kg	0.002	<ul style="list-style-type: none"> ● Kırmızı / Red ● Yeşil / Green ● Sarı / Yellow ● Mavi / Blue ● Gri / Grey ● Siyah / Black
 010 094 000010	10mm² Ray Klemens 10mm ² Rail Terminal Blocks Polyamid 66 Polyamide 66		Kutu Pack	100	2 Kg	0.003	<ul style="list-style-type: none"> ● Kırmızı / Red ● Yeşil / Green ● Sarı / Yellow ● Mavi / Blue ● Gri / Grey ● Siyah / Black
 010 094 000016	16mm² Ray Klemens 16mm ² Rail Terminal Blocks Polyamid 66 Polyamide 66		Kutu Pack	30	0.99 Kg	0.001	<ul style="list-style-type: none"> ● Kırmızı / Red ● Yeşil / Green ● Sarı / Yellow ● Mavi / Blue ● Gri / Grey ● Siyah / Black

RAY KLEMENSLER

RAIL TERMINAL BLOCKS

	Açıklama Description	Devre Circuit	Ambalaj Packing	Adet Quantity	Ağırlık Weight	Hacim Volume	Renk Color
 010 094 000035	35mm² Ray Klemens 35mm ² Rail Terminal Blocks Polyamid 66 Polyamide 66		Kutu Pack	20	1.20 Kg	0.001	<ul style="list-style-type: none"> ● Kırmızı / Red ● Yeşil / Green ● Sarı / Yellow ● Mavi / Blue ● Gri / Grey ● Siyah / Black
 010 094 010001	Durdurucu Stopper Polyamid 66 Polyamide 66		Kutu Pack	100	0.90 Kg	0.002	<ul style="list-style-type: none"> ● Gri / Grey
 010 094 010006	Yazılı Dekafix Dekafix with inscriptions		Kutu Pack	-	-	-	
 010 094 010007	Yazısız Dekafix Dekafix without inscriptions		Kutu Pack	-	-	-	
	Topraklama Ray Klemensi Grounding Rail Terminal Block 010 094 010003 2,5/4 mm 010 094 010004 6/10 mm 010 094 010005 16/35 mm		Kutu Pack	-	-	-	<ul style="list-style-type: none"> ● Yeşil / Green ● Sarı / Yellow

SIKMALI TİP KABLO PAPUÇLARI (EKO SERİ) CLAMPING TYPE CABLE TERMINAL LUGS (ECO SERIES)

	Kod Code	Açıklama Description	Ambalaj Packing	Adet Quantity	Ağırlık Weight	Hacim Volume
	123 037 000006	6 mm ²	Kutu Pack	1000	1.72 Kg	0.0023
	123 037 000010	10 mm ²	Kutu Pack	800	2.01 Kg	0.0023
	123 037 000016	16 mm ²	Kutu Pack	500	1.68 Kg	0.0023
	123 037 000025	25 mm ²	Kutu Pack	350	1.97 Kg	0.0023
	123 037 000035	35 mm ²	Kutu Pack	200	1.33 Kg	0.0023
	123 037 000050	50 mm ²	Kutu Pack	150	1.78 Kg	0.0023
	123 037 000070	70 mm ²	Kutu Pack	100	1.73 Kg	0.0023
	123 037 000095	95 mm ²	Kutu Pack	70	1.80 Kg	0.0023
	123 037 000120	120 mm ²	Kutu Pack	50	2.04 Kg	0.0023
	123 037 000150	150 mm ²	Kutu Pack	40	1.94 Kg	0.0023
	123 037 000185	185 mm ²	Kutu Pack	30	2.00 Kg	0.0023
	123 037 000240	240 mm ²	Kutu Pack	24	2.21 Kg	0.0023

SIRA KLEMENSLER

WIRE CONNECTORS

	Kod Code	Açıklama Description	Ambalaj Packing	Adet Quantity	Ağırlık Weight	Hacim Volume
	888 094 260802	2'li Geçmeli Buat Klemensi Junction Box Connector, Clickfit, Double	Kutu Pack	1	0.0033 Kg	0.000013
	888 094 260803	3'lü Geçmeli Buat Klemensi Junction Box Connector, Clickfit, Triple	Kutu Pack	1	0.0055 Kg	0.000022
	888 094 260804	4'lü Geçmeli Buat Klemensi Junction Box Connector, Clickfit, Quadruple	Kutu Pack	1	0.0066 Kg	0.000026
	888 094 260805	5'li Geçmeli Buat Klemensi Junction Box Connector, Clickfit, Quintet	Kutu Pack	1	0.0088 Kg	0.000037
	015 094 160001	Zeytin Klemens No:2 (4-6mm ²) Olive - Shaped Wire Connector No: 2 (4-6 mm ²)	Kutu Pack	1	0.018 Kg	0.000005
		<ul style="list-style-type: none"> ● Kırmızı / Red ● Yeşil / Green ● Sarı / Yellow ● Mavi / Blue ● Gri / Grey ● Siyah / Black 				
	015 094 150001	Plastik Sıra Klemens No:2 (2.5-4mm ²) Plastic Wire Connector No: 2 (2.5-4 mm ²)	Kutu Pack	50	1.5 Kg	0.002
	015 094 150002	Plastik Sıra Klemens No:2 (4-6mm ²) Plastic Wire Connector No: 2 (4-6 mm ²)	Kutu Pack	50	2.2 Kg	0.0027
	015 094 150003	Plastik Sıra Klemens No:3 (10-16mm ²) Plastic Wire Connector No: 2 (10-16 mm ²)	Kutu Pack	50	3 Kg	0.0035
	015 094 150004	Plastik Sıra Klemens No:4 (16-25mm ²) Plastic Wire Connector No: 2 (16-25 mm ²)	Kutu Pack	50	3.65 Kg	0.0050
	015 094 170001	Isıya Dayanıklı Sıra Klemens No:1 (2.5-4mm ²) Fire-Proof Wire Connector No: 2 (2.5-4 mm ²)	Kutu Pack	50	1.6 Kg	0.002
	015 094 170002	Isıya Dayanıklı Sıra Klemens No:2 (4-6mm ²) Fire-Proof Wire Connector No: 2 (4-6 mm ²)	Kutu Pack	50	2.3 Kg	0.0031
	015 094 170003	Isıya Dayanıklı Sıra Klemens No:3 (10-16mm ²) Fire-Proof Wire Connector No: 2 (10-16 mm ²)	Kutu Pack	50	3.15 Kg	0.0038
	015 094 170004	Isıya Dayanıklı Sıra Klemens No:4 (16-25mm ²) Fire-Proof Wire Connector No: 2 (16-25 mm ²)	Kutu Pack	50	4 Kg	0.0050

RAYLAR, TOPRAKLAMA ÇUBUĞU VE BARALAR

RAILS, GROUNDING ROD AND BUSBARS

	Kod Code	Açıklama Description	Ambalaj Packing	Adet Quantity	Ağırlık Weight	Hacim Volume
	014 094 020001	Ray Taşıyıcısı Rail Carrier	Kutu Pack	150	2.7 Kg	0.006
	001 025 020100 00 00	Klemens Rayı 1 mt. Wire Connector Rail, 1 m	Kutu Pack	25	13.38 Kg	0.006
	001 025 900100 00 00	W Otomat Rayı 1 mt. Fuse Box Rail, 1 m	Kutu Pack	50	16.5 Kg	0.013
	001 025 000033 00 00	W Otomat Rayı 33 cm. Fuse Box Rail, 33 cm	Kutu Pack	50	6.36 Kg	0.004
	001 025 900100 00 00	W Otomat Rayı (Delikli) 1 mt. Fuse Box Rail (Slotted) 1 m	Kutu Pack	50	15.75 Kg	0.013
	001 025 900099 99 00	W Otomat Rayı (Delikli) (Özel Boy) Fuse Box Rail (Slotted) (Custom Size)	Kutu Pack	1 mt.	0.315 Kg	0.00026
	034 025 040001	Topraklama Barası 1 mt. Grounding Busbar 1 m	Kutu Pack	10	3.6 Kg	0.0031
	091 025 010001	Topraklama Çubuğu 1 mt. (Piyasa) Grounding Rod 1 m (Commercial)	Kutu Pack	1	0.705 Kg	0.0001
	034 025 040004	Trif. Müşterek Bara İğne Uçlu 50 cm. Three-phase Common Busbar, Pintle Type, 50 cm.	Kutu Pack	25	6.69 Kg	0.0072
	034 025 040002	Mon. Müşterek Bara İğne Uçlu 1 mt. Three-phase Common Busbar, Pintle Type, 1 m	Kutu Pack	10	2.18 Kg	0.0020

DÖNER LAMBA, FLAŞÖRLÜ LAMBA VE SİRENLER

ROTATING BEACON, BLINKER BEACON AND SIRENS

	Kod Code	Açıklama Description	Renk Color
	888 111 050004	MS190 Mini Siren MS190 Mini Siren	
	888 111 050005	MS290P Plastik Siren 220V MS290P Plastic Siren 220V	
	888 111 050006	MS290M Metal Siren 220V MS290M Metallic Siren 220V	
	026 111 000001	Uçak İkaz Lambası (Ampullü) Aircraft Warning Light (with lamp)	
	026 111 000002	Uçak İkaz Lamba Sehpası Aircraft Warning Light Stand	
	026 111 010001	AS. 1 Motorlu Siren (Plastik Gövdeli) 220V, 150W AS. 1 Motorized Siren (Plastic Body) 220V, 150W	
	026 111 010002	AS. 2 Motorlu Siren (Plastik Gövdeli) 220V, 200W AS. 2 Motorized Siren (Plastic Body) 220V, 200W	
	026 111 010003	AS. 1 Motorlu Siren (Döküm Gövdeli) 220V, 150W AS. 1 Motorized Siren (Casting Body) 220V, 150W	
	026 111 010004	AS. 2 Motorlu Siren (Döküm Gövdeli) 220V, 200W AS. 2 Motorized Siren (Casting Body) 220V, 200W	
	001 111 020004 00 00	Döner Lamba 220 V Rotating Beacon, 220V	
	001 111 020001 00 00	Döner Lamba 12 V AC Rotating Beacon, 12 V AC	● Kırmızı / Red ● Sarı / Yellow ● Yeşil / Green ● Mavi / Blue
	001 111 020002 00 00	Döner Lamba 24 V AC Rotating Beacon, 24 V AC	● Kırmızı / Red ● Sarı / Yellow ● Yeşil / Green ● Mavi / Blue
	001 111 030001 00 00	Flaşörlü Lamba 12 V Blinker 12 V	● Kırmızı / Red ● Sarı / Yellow ● Yeşil / Green ● Mavi / Blue
	001 111 030002 00 00	Flaşörlü Lamba 24 V Blinker 24 V	● Kırmızı / Red ● Sarı / Yellow ● Yeşil / Green ● Mavi / Blue
	001 111 030003 00 00	Flaşörlü Lamba 220 V Blinker 220 V	● Kırmızı / Red ● Sarı / Yellow ● Yeşil / Green ● Mavi / Blue
	001 111 030003 00 11	Sabit Lamba 220 V AC Stationary Beacon 220 V AC	● Kırmızı / Red ● Sarı / Yellow ● Yeşil / Green ● Mavi / Blue

İKAZ LAMBALARI

WARNING LIGHTS

	Kod Code	Model Models
--	-------------	-----------------

GÜNEŞ ENERJİLİ SOLAR PANEL İKAZ LAMBALARI

SOLAR WARNING LIGHTS



1 007 087 400106
İL-XSLM-912V-TMK

2 007 087 400107
İL-XSL20M-TMK

3 007 087 400108
İL-XSL20M-KMK

Kod Code	Model Models
007 087 400106 İL-XSLM-912V-TMK	T90 Solar İkaz Lambası ÇAKAR 12V T90 Solar Warning Lights BEACON 12 V
007 087 400107 İL-XSL20M-TMK	T90 Solar Kule İkaz Lambası Seti ÇAKAR 12V T90 Solar Tower Warning Lights BEACON 12 V
007 087 400108 İL-XSL20M-KMK	T90 Solar Ayaklı İkaz Lambası Seti ÇAKAR 12V T90 Solar Footed Warning Lights BEACON 12 V

- Rf dalgaya yaymaz
- No RF radiation
- Stabilize ışık çıkışı
- Stabilized light output
- 12 yıl uzun ömürlü
- 12 year long life
- UV ışınlarına karşı dayanıklı
- Resistant to UV rays
- Görülebilirlik mesafesi 10 km
- Visibility distance of 10 km
- Her türlü yüzeye kolay montaj
- Easy installation on any surface
- Sabit, flaşör, çakar ve döner çalışma fonksiyonları
- Continuous, flashing, strobe signal type
- Foto sensör yardımıyla gece ve gündüz algılama
- Photo help night and sensor day detection

MULTİ VE ŞARJLI İKAZ LAMBALARI

CHARGEABLE WARNING LIGHTS



T90 MULTİ SERİ TEK GÖVDE DÖRT FARKLI ÇALIŞMA ÖZELLİĞİ
T90 MULTI SERIES ONE BODY FEATURE FOUR DIFFERENT WORK

007 087 400101 İL-XLM-VT9-24K	Multi 24 VDC
007 087 400102 İL-XLM-VT9-220K	Multi 220 VAC
007 087 400103 İL-XLMB-VT9-24K	Multi + Buzzer 24 VAC
007 087 400104 İL-XLMB-VT9-220K	Multi + Buzzer 220 VAC

T90 MULTİ SERİ TEK GÖVDE DÖRT FARKLI ÇALIŞMA ÖZELLİĞİ
T90 MULTI SERIES ONE BODY FEATURE FOUR DIFFERENT WORK

007 087 400105 İL-XJM-912V-TMK	Şarjlı, Multi + Buzzer 12 V
-----------------------------------	------------------------------------

Renk Seçenekleri
Color Options



-20° +50°
Temperature



High IP value



Shock /
Vibration
resistant





Magnetic
field proof



Power
LED Light

- Stabilize ışık çıkışı
- Stabilized light output
- Her türlü yüzeye kolay montaj
- Easy installation on any surface
- Sabit, flaşör, çakar ve döner çalışma fonksiyonları
- Continuous, flashing, strobe signal type

İKAZ LAMBALARI WARNING LIGHTS



	Kod Code	Model Models
VT6 SERİSİ TEK GÖVDEDE 5 RENK İKAZ LAMBALARI VT6 SERIES ONE BODY 5 COLOR WARNING LIGHTS		
<p>TEK GÖVDEDE 5 RENK ONE BODY 5 COLORS</p>  <p>ÖZEL TASARIM ALÜMİNYUM GÖVDEDE POWER LED SPECIAL DESIGN ALUMINIUM BODY POWER LED</p>  	129 087 000431 IL-XPS-VT6-243-A2	Sabit Işıklı 24 VDC With Stationary Light 24 VAC
	129 087 000432 IL-XPS-VT6-2203-A2	Sabit Işıklı 220 VAC With Stationary Light 220 VAC
	129 087 000433 IL-XPf-VT6-243-A2	Flaşörlü 24 VDC With Blinker 24 VDC
	129 087 000434 IL-XPf-VT6-2203-A2	Flaşörlü 220 VAC With Blinker 220 VDC
	129 087 000435 IL-XPÇ-VT6-243-A2	Çakar 24 VDC Beacon 24 VDC
	129 087 000436 IL-XPÇ-VT6-2203-A2	Çakar 220 VAC Beacon 220 VAC
	129 087 000412 IL-XPSB-VT6-243-A2	Sabit Işıklı + Buzzer 24 VDC With Stationary Light + Buzzer 24 VDC
	129 087 000413 IL-XPSB-VT6-2203-A2	Sabit Işıklı + Buzzer 220 VAC With Stationary Light + Buzzer 220 VAC
	129 087 000414 IL-XPfB-VT6-243-A2	Flaşörlü + Buzzer 24 VDC With Blinker + Buzzer 24 VDC
	129 087 000415 IL-XPfB-VT6-2203-A2	Flaşörlü + Buzzer 220 VAC With Blinker + Buzzer 220 VDC
	129 087 000416 IL-XPÇB-VT6-243-A2	Çakar + Buzzer 24 VDC Beacon + Buzzer 24 VDC
	129 087 000417 IL-XPÇB-VT6-2203-A2	Çakar + Buzzer 220 VAC Beacon + Buzzer 220 VAC
	129 087 000418 IL-XM125	Güç Konnektörü Power Connector

F7 SERİSİ 12-80 VDC MOBİL UYGULAMA İÇİN İKAZ LAMBALARI

ORANGE JUNCTION BOXES AND CASINGS



<p>GENİŞ ÇALIŞMA AKIMI 12 VDC - 80 VDC EXTENSIVE WORK FLOW 12 VDC - 80 VDC</p> 	129 087 000419 IL-XS-F7-80-A2	Sabit Işıklı 12-80 VDC With Stationary Light 12-80 VAC
	129 087 000420 IL-XS-F7-220-A2	Sabit Işıklı 220 VAC With Stationary Light 220 VAC
	129 087 000421 IL-XF-F7-80-A2	Flaşörlü 12-80 VDC With Blinker 12-80 VDC
	129 087 000422 IL-XF-F7-220-A2	Flaşörlü 220 VAC With Blinker 220 VDC
	129 087 000423 IL-XÇ-F7-80-A2	Çakar 12-80 VDC Beacon 12-80 VDC
	129 087 000424 IL-XÇ-F7-220-A2	Çakar 220 VAC Beacon 220 VAC
	129 087 000425 IL-XSB-F7-80-A2	Sabit Işıklı + Buzzer 12-80 VDC With Stationary Light + Buzzer 12-80 VDC
	129 087 000426 IL-XSB-F7-220-A2	Sabit Işıklı + Buzzer 220 VAC With Stationary Light + Buzzer 220 VAC
	129 087 000427 IL-XFB-F7-80-A2	Flaşörlü + Buzzer 12-80 VDC With Blinker + Buzzer 12-80 VDC
	129 087 000428 IL-XFB-F7-220-A2	Flaşörlü + Buzzer 220 VAC With Blinker + Buzzer 220 VDC
	129 087 000429 IL-XÇB-F7-80-A2	Çakar + Buzzer 12-80 VDC Beacon + Buzzer 12-80 VDC
	129 087 000430 IL-XÇB-F7-220-A2	Çakar + Buzzer 220 VAC Beacon + Buzzer 220 VAC

İKAZ LAMBALARI (TABANA MONTAJ) WARNING LIGHTS (FLOOR-MOUNTED)

	Kod Code	Model Models	Voltaj Voltage	Tüketim Consumptive	Ampul Lamp	Çap Diameter	Montaj Assembly	
 Lens	129 087 000014	IL-XM67S-12	Sabit Işıklı With Stationary Light	12 VAC/DC	0.9A	12 VAC/DC	67 mm	Tabana Montaj Floor Mounted
	129 087 000015	IL-XM67S-24	Sabit Işıklı With Stationary Light	24 VAC/DC	0.9A	24 VAC/DC	67 mm	Tabana Montaj Floor Mounted
	129 087 000016	IL-XM67S-48	Sabit Işıklı With Stationary Light	48 VAC/DC	0.9A	48 VAC/DC	67 mm	Tabana Montaj Floor Mounted
	129 087 000017	IL-XM67S-110	Sabit Işıklı With Stationary Light	110 VAC/DC	0.9A	110 VAC/DC	67 mm	Tabana Montaj Floor Mounted
	129 087 000018	IL-XM67S-220	Sabit Işıklı With Stationary Light	220 VAC	0.9A	220 VAC	67 mm	Tabana Montaj Floor Mounted
 Lens	129 087 000019	IL-XM67F-12	Flaşörlü With Blinker	12 VAC/DC	0.9A	12 VAC/DC	67 mm	Tabana Montaj Floor Mounted
	129 087 000020	IL-XM67F-24	Flaşörlü With Blinker	24 VAC/DC	0.9A	24 VAC/DC	67 mm	Tabana Montaj Floor Mounted
	129 087 000021	IL-XM67F-48	Flaşörlü With Blinker	48 VAC/DC	0.9A	48 VAC/DC	67 mm	Tabana Montaj Floor Mounted
	129 087 000022	IL-XM67F-110	Flaşörlü With Blinker	110 VAC/DC	0.9A	110 VAC/DC	67 mm	Tabana Montaj Floor Mounted
	129 087 000023	IL-XM67F-220	Flaşörlü With Blinker	220 VAC	0.9A	220 VAC	67 mm	Tabana Montaj Floor Mounted
 Lens	129 087 000024	IL-XM67Ç-12	Çakar Beacon	12 VAC/DC	0.9A	12 VAC/DC	67 mm	Tabana Montaj Floor Mounted
	129 087 000025	IL-XM67Ç-24	Çakar Beacon	24 VAC/DC	0.9A	24 VAC/DC	67 mm	Tabana Montaj Floor Mounted
	129 087 000026	IL-XM67Ç-48	Çakar Beacon	48 VAC/DC	0.9A	48 VAC/DC	67 mm	Tabana Montaj Floor Mounted
	129 087 000027	IL-XM67Ç-110	Çakar Beacon	110 VAC/DC	0.9A	110 VAC/DC	67 mm	Tabana Montaj Floor Mounted
	129 087 000028	IL-XM67Ç-220	Çakar Beacon	220 VAC	0.9A	220 VAC	67 mm	Tabana Montaj Floor Mounted

İKAZ LAMBALARI (TABANA MONTAJ)

WARNING LIGHTS (FLOOR-MOUNTED)

	Kod Code	Model Models	Voltaj Voltage	Tüketim Consumptive	Ampul Lamp	Çap Diameter	Montaj Assembly	
	129 087 000039	IL-XLS-VT6-12K	Sabit Işıklı With Stationary Light	12V DC	0.9A	12V 5W	60 mm	Tabana Montaj Floor Mounted
	129 087 000040	IL-XLS-VT6-24K	Sabit Işıklı With Stationary Light	24V DC	0.5A	24V 5W	60 mm	Tabana Montaj Floor Mounted
	129 087 000041	IL-XLS-VT6-220K	Sabit Işıklı With Stationary Light	220V AC	0.05A	220V 5W	60 mm	Tabana Montaj Floor Mounted
IL-X...-VT8 Serisi	129 087 000042	IL-XLF-VT6-12K	Flaşörlü With Blinker	12V DC	0.9A	12V 5W	60 mm	Tabana Montaj Floor Mounted
	129 087 000043	IL-XLF-VT6-24K	Flaşörlü With Blinker	24V DC	0.5A	24V 5W	60 mm	Tabana Montaj Floor Mounted
	129 087 000044	IL-XLF-VT6-220K	Flaşörlü With Blinker	220V AC	0.05A	220V 5W	60 mm	Tabana Montaj Floor Mounted
	129 087 000045	IL-XÇ-VT6-12K	Çakar Beacon	12V DC	0.9A	12V 5W	60 mm	Tabana Montaj Floor Mounted
	129 087 000046	IL-XÇ-VT6-24K	Çakar Beacon	24V DC	0.5A	24V 5W	60 mm	Tabana Montaj Floor Mounted
	129 087 000047	IL-XÇ-VT6-220K	Çakar Beacon	220V AC	0.05A	220V 5W	60 mm	Tabana Montaj Floor Mounted
	129 087 000048	IL-XÇ2-VT6-220K	Çift Çakar Double Beacon	220V AC	0.05A	220V 5W	60 mm	Tabana Montaj Floor Mounted
IL-X...-VT8 Serisi	129 087 000049	IL-XLD-VT6-12K	Ledli Döner Rotary With LED	12V DC	0.9A	12V 5W	60 mm	Tabana Montaj Floor Mounted
	129 087 000050	IL-XLD-VT6-24K	Ledli Döner Rotary With LED	24V DC	0.5A	24V 5W	60 mm	Tabana Montaj Floor Mounted
	129 087 000051	IL-XLD-VT6-220K	Ledli Döner Rotary With LED	220V AC	0.05A	220V 5W	60 mm	Tabana Montaj Floor Mounted
	129 087 000052	IL-XLSB-VT6-12K	Sabit Işıklı+Buzzer With Stationary Light + Buzzer	12V DC	0.9A	12V 5W	60 mm	Tabana Montaj Floor Mounted
	129 087 000053	IL-XLSB-VT6-24K	Sabit Işıklı+Buzzer With Stationary Light + Buzzer	24V DC	0.5A	24V 5W	60 mm	Tabana Montaj Floor Mounted
	129 087 000054	IL-XLSB-VT6-220K	Sabit Işıklı+Buzzer With Stationary Light + Buzzer	220V AC	0.05A	220V 5W	60 mm	Tabana Montaj Floor Mounted
IL-X...-VT8 Serisi	129 087 000055	IL-XLFB-VT6-12K	Flaşörlü+Buzzer With Blinker + Buzzer	12V DC	0.9A	12V 5W	60 mm	Tabana Montaj Floor Mounted
	129 087 000056	IL-XLFB-VT6-24K	Flaşörlü+Buzzer With Blinker + Buzzer	24V DC	0.5A	24V 5W	60 mm	Tabana Montaj Floor Mounted
	129 087 000057	IL-XLFB-VT6-220K	Flaşörlü+Buzzer With Blinker + Buzzer	220V AC	0.05A	220V 5W	60 mm	Tabana Montaj Floor Mounted
Renk Seçenekleri / Color Options: IL-XLS-VT6-12K ● IL-XLS-VT6-12S ● IL-XM67S-12Y ● IL-XLS-VT6-12M ● IL-XLS-VT6-12B ○								

İKAZ LAMBALARI (VİDA BAĞLANTILI)

WARNING LIGHTS (SCREW CONNECTION)

	Kod Code	Model Models	Voltaj Voltage	Tüketim Consumptive	Ampul Lamp	Çap Diameter	Montaj Assembly
 IL-X...-VT8 Serisi	129 087 000058	IL-XÇB-VT6-12K Çakar + Buzzer Beacon + Buzzer	12 VAC/DC	0.9A	12 VAC/DC	84 mm	Vida Bağlantı Screw Connection
	129 087 000059	IL-XÇB-VT6-24K Çakar + Buzzer Beacon + Buzzer	24 VAC/DC	0.9A	24 VAC/DC	84 mm	Vida Bağlantı Screw Connection
	129 087 000060	IL-XÇB-VT6-220K Çakar + Buzzer Beacon + Buzzer	48 VAC/DC	0.9A	48 VAC/DC	84 mm	Vida Bağlantı Screw Connection
	129 087 000061	IL-XLDB-VT6-12K Ledli Döner + Buzzer Rotary with LED + Buzzer	12 VAC/DC	0.9A	12 VAC/DC	84 mm	Vida Bağlantı Screw Connection
	129 087 000062	IL-XLDB-VT6-24K Ledli Döner + Buzzer Rotary with LED + Buzzer	24 VAC/DC	0.9A	24 VAC/DC	84 mm	Vida Bağlantı Screw Connection
	129 087 000063	IL-XLDB-VT6-220K Ledli Döner + Buzzer Rotary with LED + Buzzer	48 VAC/DC	0.9A	48 VAC/DC	84 mm	Vida Bağlantı Screw Connection
 IL-X...-V8 Serisi	129 087 000064	IL-XLS-V8-12K Sabit Işıklı With Stationary Light	12V DC	0.9A	12V 5W	84 mm	Vida Bağlantı Screw Connection
	129 087 000065	IL-XLS-V8-24K Sabit Işıklı With Stationary Light	24V DC	0.5A	24V 5W	84 mm	Vida Bağlantı Screw Connection
	129 087 000066	IL-XLS-V8-220K Sabit Işıklı With Stationary Light	220V AC	0.05A	220V 5W	84 mm	Vida Bağlantı Screw Connection
	129 087 000067	IL-XLF-V8-12K Flaşörlü With Blinker	12V DC	0.9A	12V 5W	84 mm	Vida Bağlantı Screw Connection
	129 087 000068	IL-XLF-V8-24K Flaşörlü With Blinker	24V DC	0.5A	24V 5W	84 mm	Vida Bağlantı Screw Connection
	129 087 000069	IL-XLF-V8-220K Flaşörlü With Blinker	220V AC	0.05A	220V 5W	84 mm	Vida Bağlantı Screw Connection
	129 087 000070	IL-XÇ-V8-12K Çakar Beacon	12V DC	0.9A	12V 5W	84 mm	Vida Bağlantı Screw Connection
	129 087 000071	IL-XÇ-V8-24K Çakar Beacon	24V DC	0.5A	24V 5W	84 mm	Vida Bağlantı Screw Connection
	129 087 000072	IL-XÇ-V8-220K Çakar Beacon	220V AC	0.05A	220V 5W	84 mm	Vida Bağlantı Screw Connection
	129 087 000073	IL-XÇ2-V8-220K Çift Çakar Double Beacon	220V AC	0.05A	220V 5W	84 mm	Vida Bağlantı Screw Connection
	129 087 000074	IL-XLD-V8-12K Ledli Döner Rotary With LED	12V DC	0.9A	12V 5W	84 mm	Vida Bağlantı Screw Connection
	129 087 000075	IL-XLD-V8-24K Ledli Döner Rotary With LED	24V DC	0.5A	24V 5W	84 mm	Vida Bağlantı Screw Connection
129 087 000076	IL-XLD-V8-220K Ledli Döner Rotary With LED	220V AC	0.05A	220V 5W	84 mm	Vida Bağlantı Screw Connection	
 IL-X...-V8 Serisi	129 087 000077	IL-XLSB-V8-12K Sabit Işıklı+Buzzer With Stationary Light + Buzzer	12V DC	0.9A	12V 5W	84 mm	Vida Bağlantı Screw Connection
	129 087 000078	IL-XLSB-V8-24K Sabit Işıklı+Buzzer With Stationary Light + Buzzer	24V DC	0.5A	24V 5W	84 mm	Vida Bağlantı Screw Connection
	129 087 000079	IL-XLSB-V8-220K Sabit Işıklı+Buzzer With Stationary Light + Buzzer	220V AC	0.05A	220V 5W	84 mm	Vida Bağlantı Screw Connection
	129 087 000080	IL-XLFB-V8-12K Flaşörlü+Buzzer With Blinker + Buzzer	12V DC	0.9A	12V 5W	84 mm	Vida Bağlantı Screw Connection
	129 087 000081	IL-XLFB-V8-24K Flaşörlü+Buzzer With Blinker + Buzzer	24V DC	0.5A	24V 5W	84 mm	Vida Bağlantı Screw Connection
	129 087 000082	IL-XLFB-V8-220K Flaşörlü+Buzzer With Blinker + Buzzer	220V AC	0.05A	220V 5W	84 mm	Vida Bağlantı Screw Connection
	129 087 000083	IL-XÇB-V8-12K Çakar + Buzzer Beacon + Buzzer	12 VAC/DC	0.9A	12 VAC/DC	84 mm	Vida Bağlantı Screw Connection
	129 087 000084	IL-XÇB-V8-24K Çakar + Buzzer Beacon + Buzzer	24 VAC/DC	0.9A	24 VAC/DC	84 mm	Vida Bağlantı Screw Connection
	129 087 000085	IL-XÇB-V8-220K Çakar + Buzzer Beacon + Buzzer	48 VAC/DC	0.9A	48 VAC/DC	84 mm	Vida Bağlantı Screw Connection
	129 087 000086	IL-XLDB-V8-12K Ledli Döner + Buzzer Rotary with LED + Buzzer	12 VAC/DC	0.9A	12 VAC/DC	84 mm	Vida Bağlantı Screw Connection
	129 087 000087	IL-XLDB-V8-24K Ledli Döner + Buzzer Rotary with LED + Buzzer	24 VAC/DC	0.9A	24 VAC/DC	84 mm	Vida Bağlantı Screw Connection
	129 087 000088	IL-XLDB-V8-220K Ledli Döner + Buzzer Rotary with LED + Buzzer	48 VAC/DC	0.9A	48 VAC/DC	84 mm	Vida Bağlantı Screw Connection
Renk Seçenekleri / Color Options: IL-XLS-V8-12K ● IL-XLS-V8-12S ● IL-XLS-V8-12Y ● IL-XLS-V8-12M ● IL-XLS-V8-12B ○							

İKAZ LAMBALARI (VİDA BAĞLANTILI)

WARNING LIGHTS (SCREW CONNECTION)

	Kod Code	Model Models	Voltaj Voltage	Tüketim Consumptive	Ampul Lamp	Çap Diameter	Montaj Assembly
 <p>IL-X...-T8 Serisi</p>	129 087 000089	IL-XLS-T8-12K Sabit Işıklı With Stationary Light	12V DC	0.9A	12V 5W	84 mm	Tabana Montaj Floor-mounted
	129 087 000090	IL-XLS-T8-24K Sabit Işıklı With Stationary Light	24V DC	0.5A	24V 5W	84 mm	Tabana Montaj Floor-mounted
	129 087 000091	IL-XLS-T8-220K Sabit Işıklı With Stationary Light	220V AC	0.05A	220V 5W	84 mm	Tabana Montaj Floor-mounted
	129 087 000092	IL-XLF-T8-12K Flaşörlü With Blinker	12V DC	0.9A	12V 5W	84 mm	Tabana Montaj Floor-mounted
	129 087 000093	IL-XLF-T8-24K Flaşörlü With Blinker	24V DC	0.5A	24V 5W	84 mm	Tabana Montaj Floor-mounted
	129 087 000094	IL-XLF-T8-220K Flaşörlü With Blinker	220V AC	0.05A	220V 5W	84 mm	Tabana Montaj Floor-mounted
	129 087 000095	IL-XÇ-T8-12K Çakar Beacon	12V DC	0.9A	12V 5W	84 mm	Tabana Montaj Floor-mounted
	129 087 000096	IL-XÇ-T8-24K Çakar Beacon	24V DC	0.5A	24V 5W	84 mm	Tabana Montaj Floor-mounted
	129 087 000097	IL-XÇ-T8-220K Çakar Beacon	220V AC	0.05A	220V 5W	84 mm	Tabana Montaj Floor-mounted
	129 087 000098	IL-XÇ2-T8-220K Çift Çakar Double Beacon	220V AC	0.05A	220V 5W	84 mm	Tabana Montaj Floor-mounted
	129 087 000099	IL-XLD-T8-120K Ledli Döner Rotary With LED	12V DC	0.9A	12V 5W	84 mm	Tabana Montaj Floor-mounted
	129 087 000100	IL-XLD-T8-24K Ledli Döner Rotary With LED	24V DC	0.5A	24V 5W	84 mm	Tabana Montaj Floor-mounted
129 087 000101	IL-XLD-T8-220K Ledli Döner Rotary With LED	220V AC	0.05A	220V 5W	84 mm	Tabana Montaj Floor-mounted	
 <p>IL-X...-T8 Serisi</p>	129 087 000102	IL-XLSB-T8-12K Sabit Işıklı + Buzzer With Stationary Light + Buzzer	12V DC	0.9A	12V 5W	84 mm	Tabana Montaj Floor-mounted
	129 087 000103	IL-XLSB-T8-24K Sabit Işıklı + Buzzer With Stationary Light + Buzzer	24V DC	0.5A	24V 5W	84 mm	Tabana Montaj Floor-mounted
	129 087 000104	IL-XLSB-T8-220K Sabit Işıklı + Buzzer With Stationary Light + Buzzer	220V AC	0.05A	220V 5W	84 mm	Tabana Montaj Floor-mounted
	129 087 000105	IL-XLFB-T8-12K Flaşörlü + Buzzer With Blinker + Buzzer	12V DC	0.9A	12V 5W	84 mm	Tabana Montaj Floor-mounted
	129 087 000106	IL-XLFB-T8-24K Flaşörlü + Buzzer With Blinker + Buzzer	24V DC	0.5A	24V 5W	84 mm	Tabana Montaj Floor-mounted
	129 087 000107	IL-XLFB-T8-220K Flaşörlü + Buzzer With Blinker + Buzzer	220V AC	0.05A	220V 5W	84 mm	Tabana Montaj Floor-mounted
	129 087 000108	IL-XÇB-T8-12K Çakar + Buzzer Beacon + Buzzer	12 VAC/DC	0.9A	12 VAC/DC	84 mm	Tabana Montaj Floor-mounted
	129 087 000109	IL-XÇB-T8-24K Çakar + Buzzer Beacon + Buzzer	24 VAC/DC	0.9A	24 VAC/DC	84 mm	Tabana Montaj Floor-mounted
	129 087 000110	IL-XÇB-T8-220K Çakar + Buzzer Beacon + Buzzer	48 VAC/DC	0.9A	48 VAC/DC	84 mm	Tabana Montaj Floor-mounted
	129 087 000111	IL-XLDB-T8-12K Ledli Döner + Buzzer Rotary with LED + Buzzer	12 VAC/DC	0.9A	12 VAC/DC	84 mm	Tabana Montaj Floor-mounted
	129 087 000112	IL-XLDB-T8-24K Ledli Döner + Buzzer Rotary with LED + Buzzer	24 VAC/DC	0.9A	24 VAC/DC	84 mm	Tabana Montaj Floor-mounted
	129 087 000113	IL-XLDB-T8-220K Ledli Döner + Buzzer Rotary with LED + Buzzer	48 VAC/DC	0.9A	48 VAC/DC	84 mm	Tabana Montaj Floor-mounted

Renk Seçenekleri / Color Options: IL-XLS-T8-12K ● IL-XLS-T8-12S ● IL-XLS-T8-12Y ● IL-XLS-T8-12M ● IL-XLS-T8-12B ○

İKAZ LAMBALARI (TABANA MONTAJ)

WARNING LIGHTS (FLOOR-MOUNTED)

	Kod Code	Model Models	Voltaj Voltage	Tüketim Consumptive	Ampul Lamp	Çap Diameter	Montaj Assembly
 <p>IL-X...-VT8 Serisi</p>	129 087 000114	IL-XLS-VT8-12K Sabit Işıklı With Stationary Light	12V DC	0.9A	12V 5W	84 mm	Tabana Montaj Floor-mounted
	129 087 000115	IL-XLS-VT8-24K Sabit Işıklı With Stationary Light	24V DC	0.5A	24V 5W	84 mm	Tabana Montaj Floor-mounted
	129 087 000116	IL-XLS-VT8-220K Sabit Işıklı With Stationary Light	220V AC	0.05A	220V 5W	84 mm	Tabana Montaj Floor-mounted
	129 087 000117	IL-XLF-VT8-12K Flaşörlü With Blinker	12V DC	0.9A	12V 5W	84 mm	Tabana Montaj Floor-mounted
	129 087 000118	IL-XLF-VT8-24K Flaşörlü With Blinker	24V DC	0.5A	24V 5W	84 mm	Tabana Montaj Floor-mounted
	129 087 000119	IL-XLF-VT8-220K Flaşörlü With Blinker	220V AC	0.05A	220V 5W	84 mm	Tabana Montaj Floor-mounted
	129 087 000120	IL-XÇ-VT8-12K Çakar Beacon	12V DC	0.9A	12V 5W	84 mm	Tabana Montaj Floor-mounted
	129 087 000121	IL-XÇ-VT8-24K Çakar Beacon	24V DC	0.5A	24V 5W	84 mm	Tabana Montaj Floor-mounted
	129 087 000122	IL-XÇ-VT8-220K Çakar Beacon	220V AC	0.05A	220V 5W	84 mm	Tabana Montaj Floor-mounted
	129 087 000123	IL-XÇ2-VT8-220K Çift Çakar Double Beacon	220V AC	0.05A	220V 5W	84 mm	Tabana Montaj Floor-mounted
	129 087 000124	IL-XLD-VT8-12K Ledli Döner Rotary With LED	12V DC	0.9A	12V 5W	84 mm	Tabana Montaj Floor-mounted
	129 087 000125	IL-XLD-VT8-24K Ledli Döner Rotary With LED	24V DC	0.5A	24V 5W	84 mm	Tabana Montaj Floor-mounted
129 087 000126	IL-XLD-VT8-220K Ledli Döner Rotary With LED	220V AC	0.05A	220V 5W	84 mm	Tabana Montaj Floor-mounted	
 <p>IL-X...-VT8 Serisi</p>	129 087 000127	IL-XLSB-VT8-12K Sabit Işıklı + Buzzer With Stationary Light + Buzzer	12V DC	0.9A	12V 5W	84 mm	Tabana Montaj Floor-mounted
	129 087 000128	IL-XLSB-VT8-24K Sabit Işıklı + Buzzer With Stationary Light + Buzzer	24V DC	0.5A	24V 5W	84 mm	Tabana Montaj Floor-mounted
	129 087 000129	IL-XLSB-VT8-220K Sabit Işıklı + Buzzer With Stationary Light + Buzzer	220V AC	0.05A	220V 5W	84 mm	Tabana Montaj Floor-mounted
	129 087 000130	IL-XLFB-VT8-12K Flaşörlü + Buzzer With Blinker + Buzzer	12V DC	0.9A	12V 5W	84 mm	Tabana Montaj Floor-mounted
	129 087 000131	IL-XLFB-VT8-24K Flaşörlü + Buzzer With Blinker + Buzzer	24V DC	0.5A	24V 5W	84 mm	Tabana Montaj Floor-mounted
	129 087 000132	IL-XLFB-VT8-220K Flaşörlü + Buzzer With Blinker + Buzzer	220V AC	0.05A	220V 5W	84 mm	Tabana Montaj Floor-mounted
	129 087 000133	IL-XÇB-VT8-12K Çakar + Buzzer Beacon + Buzzer	12 VAC/DC	0.9A	12 VAC/DC	84 mm	Tabana Montaj Floor-mounted
	129 087 000134	IL-XÇB-VT8-24K Çakar + Buzzer Beacon + Buzzer	24 VAC/DC	0.9A	24 VAC/DC	84 mm	Tabana Montaj Floor-mounted
	129 087 000135	IL-XÇB-VT8-220K Çakar + Buzzer Beacon + Buzzer	48 VAC/DC	0.9A	48 VAC/DC	84 mm	Tabana Montaj Floor-mounted
	129 087 000136	IL-XLDB-VT8-12K Ledli Döner + Buzzer Rotary with LED + Buzzer	12 VAC/DC	0.9A	12 VAC/DC	84 mm	Tabana Montaj Floor-mounted
	129 087 000137	IL-XLDB-VT8-24K Ledli Döner + Buzzer Rotary with LED + Buzzer	24 VAC/DC	0.9A	24 VAC/DC	84 mm	Tabana Montaj Floor-mounted
	129 087 000138	IL-XLDB-VT8-220K Ledli Döner + Buzzer Rotary with LED + Buzzer	48 VAC/DC	0.9A	48 VAC/DC	84 mm	Tabana Montaj Floor-mounted
Renk Seçenekleri / Color Options: IL-XLS-VT8-12K ● IL-XLS-VT8-12S ● IL-XLS-VT8-12Y ● IL-XLS-VT8-12M ● IL-XLS-VT8-12B ○							

İKAZ LAMBALARI (TABANA MONTAJ)

WARNING LIGHTS (FLOOR-MOUNTED)

	Kod Code	Model Models	Voltaj Voltage	Tüketim Consumptive	Ampul Lamp	Çap Diameter	Montaj Assembly	
 IL-X...-VT10 Serisi	129 087 000139	IL-XLS-VT10-12K Sabit Işıklı With Stationary Light	12V DC	0.9A	12V 5W	100 mm	Tabana Montaj Floor-mounted	
	129 087 000140	IL-XLS-VT10-24K Sabit Işıklı With Stationary Light	24V DC	0.5A	24V 5W	100 mm	Tabana Montaj Floor-mounted	
	129 087 000141	IL-XLS-VT10-220K Sabit Işıklı With Stationary Light	220V AC	0.05A	220V 5W	100 mm	Tabana Montaj Floor-mounted	
	129 087 000142	IL-XLF-VT10-12K Flaşörlü With Blinker	12V DC	0.9A	12V 5W	100 mm	Tabana Montaj Floor-mounted	
	129 087 000143	IL-XLF-VT10-24K Flaşörlü With Blinker	24V DC	0.5A	24V 5W	100 mm	Tabana Montaj Floor-mounted	
	129 087 000144	IL-XLF-VT10-220K Flaşörlü With Blinker	220V AC	0.05A	220V 5W	100 mm	Tabana Montaj Floor-mounted	
	129 087 000145	IL-XÇ-VT10-12K Çakar Beacon	12V DC	0.9A	12V 5W	100 mm	Tabana Montaj Floor-mounted	
	129 087 000146	IL-XÇ-VT10-24K Çakar Beacon	24V DC	0.5A	24V 5W	100 mm	Tabana Montaj Floor-mounted	
	129 087 000147	IL-XÇ-VT10-220K Çakar Beacon	220V AC	0.05A	220V 5W	100 mm	Tabana Montaj Floor-mounted	
129 087 000148	IL-XÇ2-VT10-220K Çift Çakar Double Beacon	220V AC	0.05A	220V 5W	100 mm	Tabana Montaj Floor-mounted		
 IL-X...-VT10 Serisi	129 087 000149	IL-XLD-VT10-12K Ledli Döner Rotary With LED	12V DC	0.9A	12V 5W	100 mm	Tabana Montaj Floor-mounted	
	129 087 000150	IL-XLD-VT10-24K Ledli Döner Rotary With LED	24V DC	0.5A	24V 5W	100 mm	Tabana Montaj Floor-mounted	
	129 087 000151	IL-XLD-VT10-220K Ledli Döner Rotary With LED	220V AC	0.05A	220V 5W	100 mm	Tabana Montaj Floor-mounted	
	129 087 000152	IL-XLSB-VT10-12K Sabit Işıklı+Buzzer With Stationary Light + Buzzer	12V DC	0.9A	12V 5W	100 mm	Tabana Montaj Floor-mounted	
	129 087 000153	IL-XLSB-VT10-24K Sabit Işıklı+Buzzer With Stationary Light + Buzzer	24V DC	0.5A	24V 5W	100 mm	Tabana Montaj Floor-mounted	
	129 087 000154	IL-XLSB-VT10-220K Sabit Işıklı+Buzzer With Stationary Light + Buzzer	220V AC	0.05A	220V 5W	100 mm	Tabana Montaj Floor-mounted	
	129 087 000155	IL-XLFB-VT10-12K Flaşörlü+Buzzer With Blinker + Buzzer	12V DC	0.9A	12V 5W	100 mm	Tabana Montaj Floor-mounted	
	129 087 000156	IL-XLFB-VT10-24K Flaşörlü+Buzzer With Blinker + Buzzer	24V DC	0.5A	24V 5W	100 mm	Tabana Montaj Floor-mounted	
	129 087 000157	IL-XLFB-VT10-220K Flaşörlü+Buzzer With Blinker + Buzzer	220V AC	0.05A	220V 5W	100 mm	Tabana Montaj Floor-mounted	
 IL-X...-VT10 Serisi	129 087 000158	IL-XÇB-VT10-12K Çakar + Buzzer Beacon + Buzzer	12 VAC/DC	0.9A	12 VAC/DC	100 mm	Tabana Montaj Floor-mounted	
	129 087 000159	IL-XÇB-VT10-24K Çakar + Buzzer Beacon + Buzzer	24 VAC/DC	0.9A	24 VAC/DC	100 mm	Tabana Montaj Floor-mounted	
	129 087 000160	IL-XÇB-VT10-220K Çakar + Buzzer Beacon + Buzzer	48 VAC/DC	0.9A	48 VAC/DC	100 mm	Tabana Montaj Floor-mounted	
	129 087 000161	IL-XLDB-VT10-12K Ledli Döner + Buzzer Rotary with LED + Buzzer	12 VAC/DC	0.9A	12 VAC/DC	100 mm	Tabana Montaj Floor-mounted	
	129 087 000162	IL-XLDB-VT10-24K Ledli Döner + Buzzer Rotary with LED + Buzzer	24 VAC/DC	0.9A	24 VAC/DC	100 mm	Tabana Montaj Floor-mounted	
	129 087 000163	IL-XLDB-VT10-220K Ledli Döner + Buzzer Rotary with LED + Buzzer	48 VAC/DC	0.9A	48 VAC/DC	100 mm	Tabana Montaj Floor-mounted	
	Renk Seçenekleri / Color Options: IL-XLS-VT10-12K ● IL-XLS-VT10-12S ● IL-XLS-VT10-12Y ● IL-XLS-VT10-12M ● IL-XLS-VT10-12B ○							





İKAZ LAMBALARI (TABANA MONTAJ)

WARNING LIGHTS (FLOOR-MOUNTED)

	Kod Code	Model Models	Voltaj Voltage	Tüketim Consumptive	Ampul Lamp	Çap Diameter	Montaj Assembly
 <p>IL-X...-VT12 Serisi</p>	129 087 000164	IL-XLS-VT12-12K Sabit Işıklı With Stationary Light	12V DC	0.9A	12V 5W	120 mm	Tabana Montaj Floor-mounted
	129 087 000165	IL-XLS-VT12-24K Sabit Işıklı With Stationary Light	24V DC	0.5A	24V 5W	120 mm	Tabana Montaj Floor-mounted
	129 087 000166	IL-XLS-VT12-220K Sabit Işıklı With Stationary Light	220V AC	0.05A	220V 5W	120 mm	Tabana Montaj Floor-mounted
	129 087 000167	IL-XLF-VT12-12K Flaşörlü With Blinker	12V DC	0.9A	12V 5W	120 mm	Tabana Montaj Floor-mounted
	129 087 000168	IL-XLF-VT12-24K Flaşörlü With Blinker	24V DC	0.5A	24V 5W	120 mm	Tabana Montaj Floor-mounted
	129 087 000169	IL-XLF-VT12-220K Flaşörlü With Blinker	220V AC	0.05A	220V 5W	120 mm	Tabana Montaj Floor-mounted
 <p>IL-X...-VT12 Serisi</p>	129 087 000170	IL-XÇ-VT12-12K Çakar Beacon	12V DC	0.9A	12V 5W	120 mm	Tabana Montaj Floor-mounted
	129 087 000171	IL-XÇ-VT12-24K Çakar Beacon	24V DC	0.5A	24V 5W	120 mm	Tabana Montaj Floor-mounted
	129 087 000172	IL-XÇ-VT12-220K Çakar Beacon	220V AC	0.05A	220V 5W	120 mm	Tabana Montaj Floor-mounted
	129 087 000173	IL-XÇ2-VT12-220K Çift Çakar Double Beacon	220V AC	0.05A	220V 5W	120 mm	Tabana Montaj Floor-mounted
 <p>IL-X...-VT12 Serisi</p>	129 087 000174	IL-XLD-VT12-12K Ledli Döner Rotary With LED	12V DC	0.9A	12V 5W	120 mm	Tabana Montaj Floor-mounted
	129 087 000175	IL-XLD-VT12-24K Ledli Döner Rotary With LED	24V DC	0.5A	24V 5W	120 mm	Tabana Montaj Floor-mounted
	129 087 000176	IL-XLD-VT12-220K Ledli Döner Rotary With LED	220V AC	0.05A	220V 5W	120 mm	Tabana Montaj Floor-mounted
	129 087 000177	IL-XLSB-VT12-12K Sabit Işıklı+Buzzer With Stationary Light + Buzzer	12V DC	0.9A	12V 5W	120 mm	Tabana Montaj Floor-mounted
	129 087 000178	IL-XLSB-VT12-24K Sabit Işıklı+Buzzer With Stationary Light + Buzzer	24V DC	0.5A	24V 5W	120 mm	Tabana Montaj Floor-mounted
	129 087 000179	IL-XLSB-VT12-220K Sabit Işıklı+Buzzer With Stationary Light + Buzzer	220V AC	0.05A	220V 5W	120 mm	Tabana Montaj Floor-mounted
 <p>IL-X...-VT12 Serisi</p>	129 087 000180	IL-XLFB-VT12-12K Flaşörlü+Buzzer With Blinker + Buzzer	12V DC	0.9A	12V 5W	120 mm	Tabana Montaj Floor-mounted
	129 087 000181	IL-XLFB-VT12-24K Flaşörlü+Buzzer With Blinker + Buzzer	24V DC	0.5A	24V 5W	120 mm	Tabana Montaj Floor-mounted
	129 087 000182	IL-XLFB-VT12-220K Flaşörlü+Buzzer With Blinker + Buzzer	220V AC	0.05A	220V 5W	120 mm	Tabana Montaj Floor-mounted
	129 087 000183	IL-XÇB-VT12-12K Çakar + Buzzer Beacon + Buzzer	12 VAC/DC	0.9A	12 VAC/DC	120 mm	Tabana Montaj Floor-mounted
	129 087 000184	IL-XÇB-VT12-24K Çakar + Buzzer Beacon + Buzzer	24 VAC/DC	0.9A	24 VAC/DC	120 mm	Tabana Montaj Floor-mounted
	129 087 000185	IL-XÇB-VT12-220K Çakar + Buzzer Beacon + Buzzer	48 VAC/DC	0.9A	48 VAC/DC	120 mm	Tabana Montaj Floor-mounted
	129 087 000186	IL-XLDB-VT12-12K Ledli Döner + Buzzer Rotary with LED + Buzzer	12 VAC/DC	0.9A	12 VAC/DC	120 mm	Tabana Montaj Floor-mounted
	129 087 000187	IL-XLDB-VT12-24K Ledli Döner + Buzzer Rotary with LED + Buzzer	24 VAC/DC	0.9A	24 VAC/DC	120 mm	Tabana Montaj Floor-mounted
	129 087 000188	IL-XLDB-VT12-220K Ledli Döner + Buzzer Rotary with LED + Buzzer	48 VAC/DC	0.9A	48 VAC/DC	120 mm	Tabana Montaj Floor-mounted
Renk Seçenekleri / Color Options: IL-XLS-VT12-12K ● IL-XLS-VT12-12S ● IL-XLS-VT12-12Y ● IL-XLS-VT12-12M ● IL-XLS-VT12-12B ○							

İKAZ LAMBALARI (TABANA MONTAJ)

WARNING LIGHTS (FLOOR-MOUNTED)

	Kod Code	Model Models	Voltaj Voltage	Tüketim Consumptive	Ampul Lamp	Çap Diameter	Montaj Assembly
	129 087 000189	IL-XLSB-B-12K Sabit Işıklı + Buzzer With Stationary Light + Buzzer	12 V	0.9A	12 VAC/DC	67 mm	Tabana Montaj Floor-mounted
	129 087 000190	IL-XLSB-B-24K Sabit Işıklı + Buzzer With Stationary Light + Buzzer	24 V	0.9A	24 VAC/DC	67 mm	Tabana Montaj Floor-mounted
	129 087 000191	IL-XLSB-B-48K Sabit Işıklı + Buzzer With Stationary Light + Buzzer	48 V	0.9A	48 VAC/DC	67 mm	Tabana Montaj Floor-mounted
	129 087 000192	IL-XLSB-B-110K Sabit Işıklı + Buzzer With Stationary Light + Buzzer	110 V	0.9A	110 VAC/DC	67 mm	Tabana Montaj Floor-mounted
	129 087 000193	IL-XLSB-B-220K Sabit Işıklı + Buzzer With Stationary Light + Buzzer	220 V	0.9A	220 VAC/DC	67 mm	Tabana Montaj Floor-mounted
	129 087 000194	IL-XLFB-B-12K Flaşörlü + Buzzer With Blinker + Buzzer	12 V	0.9A	12 VAC/DC	67 mm	Tabana Montaj Floor-mounted
	129 087 000195	IL-XLFB-B-24K Flaşörlü + Buzzer With Blinker + Buzzer	24 V	0.9A	24 VAC/DC	67 mm	Tabana Montaj Floor-mounted
	129 087 000196	IL-XLFB-B-48K Flaşörlü + Buzzer With Blinker + Buzzer	48 V	0.9A	48 VAC/DC	67 mm	Tabana Montaj Floor-mounted
	129 087 000197	IL-XLFB-B-110K Flaşörlü + Buzzer With Blinker + Buzzer	110 V	0.9A	110 VAC/DC	67 mm	Tabana Montaj Floor-mounted
	129 087 000198	IL-XLFB-B-220K Flaşörlü + Buzzer With Blinker + Buzzer	220 V	0.9A	220 VAC/DC	67 mm	Tabana Montaj Floor-mounted
	129 087 000199	IL-XÇB-B-12K Çakar + Buzzer Beacon + Buzzer	12 V	0.9A	12 VAC/DC	67 mm	Tabana Montaj Floor-mounted
	129 087 000200	IL-XÇB-B-24K Çakar + Buzzer Beacon + Buzzer	24 V	0.9A	24 VAC/DC	67 mm	Tabana Montaj Floor-mounted
	129 087 000201	IL-XÇB-B-48K Çakar + Buzzer Beacon + Buzzer	48 V	0.9A	48 VAC/DC	67 mm	Tabana Montaj Floor-mounted
	129 087 000202	IL-XÇB-B-110K Çakar + Buzzer Beacon + Buzzer	110 V	0.9A	110 VAC/DC	67 mm	Tabana Montaj Floor-mounted
	129 087 000203	IL-XÇB-B-220K Çakar + Buzzer Beacon + Buzzer	220 V	0.9A	220 VAC/DC	67 mm	Tabana Montaj Floor-mounted
	129 087 000204	IL-XLDB-B-12K Döner + Buzzer Rotary + Buzzer	12 V	0.9A	12 VAC/DC	67 mm	Tabana Montaj Floor-mounted
	129 087 000205	IL-XLDB-B-24K Döner + Buzzer Rotary + Buzzer	24 V	0.9A	24 VAC/DC	67 mm	Tabana Montaj Floor-mounted
	129 087 000206	IL-XLDB-B-48K Döner + Buzzer Rotary + Buzzer	48 V	0.9A	48 VAC/DC	67 mm	Tabana Montaj Floor-mounted
	129 087 000207	IL-XLDB-B-110K Döner + Buzzer Rotary + Buzzer	110 V	0.9A	110 VAC/DC	67 mm	Tabana Montaj Floor-mounted
	129 087 000208	IL-XLDB-B-220K Döner + Buzzer Rotary + Buzzer	220 V	0.9A	220 VAC/DC	67 mm	Tabana Montaj Floor-mounted
Renk Seçenekleri / Color Options: IL-XLB-B-12K ● IL-XLB-B-12S ● IL-XLB-B-12Y ● IL-XLB-B-12M ● IL-XLB-B-12B ○							
	129 087 000209	IL-XLSB-Q-12K Sabit Işıklı + Buzzer With Stationary Light + Buzzer	12 V	0.9A	12 VAC/DC	67 mm	Tabana Montaj Floor-mounted
	129 087 000210	IL-XLSB-Q-24K Sabit Işıklı + Buzzer With Stationary Light + Buzzer	24 V	0.9A	24 VAC/DC	67 mm	Tabana Montaj Floor-mounted
	129 087 000211	IL-XLSB-Q-48K Sabit Işıklı + Buzzer With Stationary Light + Buzzer	48 V	0.9A	48 VAC/DC	67 mm	Tabana Montaj Floor-mounted
	129 087 000212	IL-XLSB-Q-110K Sabit Işıklı + Buzzer With Stationary Light + Buzzer	110 V	0.9A	110 VAC/DC	67 mm	Tabana Montaj Floor-mounted
	129 087 000213	IL-XLSB-Q-220K Sabit Işıklı + Buzzer With Stationary Light + Buzzer	220 V	0.9A	220 VAC/DC	67 mm	Tabana Montaj Floor-mounted
	129 087 000214	IL-XLFB-Q-12K Flaşörlü + Buzzer With Blinker + Buzzer	12 V	0.9A	12 VAC/DC	67 mm	Tabana Montaj Floor-mounted
	129 087 000215	IL-XLFB-Q-24K Flaşörlü + Buzzer With Blinker + Buzzer	24 V	0.9A	24 VAC/DC	67 mm	Tabana Montaj Floor-mounted
	129 087 000216	IL-XLFB-Q-48K Flaşörlü + Buzzer With Blinker + Buzzer	48 V	0.9A	48 VAC/DC	67 mm	Tabana Montaj Floor-mounted
	129 087 000217	IL-XLFB-Q-110K Flaşörlü + Buzzer With Blinker + Buzzer	110 V	0.9A	110 VAC/DC	67 mm	Tabana Montaj Floor-mounted
	129 087 000218	IL-XLFB-Q-220K Flaşörlü + Buzzer With Blinker + Buzzer	220 V	0.9A	220 VAC/DC	67 mm	Tabana Montaj Floor-mounted

1 KATLI IŞIKLI KOLONLAR

1-STOREY ILLUMINATED COLUMNS



	Kod Code	Model Models	Voltaj Voltage	Tüketim Consumptive	Ampul Lamp	Çap Diameter	Montaj Assembly
	129 087 000219	IL-XÇB-Q-12K Çakar + Buzzer Beacon + Buzzer	12 V	0.9A	12 VAC/DC	67 mm	Tabana Montaj Floor-mounted
	129 087 000220	IL-XÇB-Q-24K Çakar + Buzzer Beacon + Buzzer	24 V	0.9A	24 VAC/DC	67 mm	Tabana Montaj Floor-mounted
	129 087 000221	IL-XÇB-Q-48K Çakar + Buzzer Beacon + Buzzer	48 V	0.9A	48 VAC/DC	67 mm	Tabana Montaj Floor-mounted
	129 087 000222	IL-XÇB-Q-110K Çakar + Buzzer Beacon + Buzzer	110 V	0.9A	110 VAC/DC	67 mm	Tabana Montaj Floor-mounted
	129 087 000223	IL-XÇB-Q-220K Çakar + Buzzer Beacon + Buzzer	220 V	0.9A	220 VAC/DC	67 mm	Tabana Montaj Floor-mounted
	129 087 000224	IL-XLDB-Q-12K Döner + Buzzer Rotary + Buzzer	12 V	0.9A	12 VAC/DC	67 mm	Tabana Montaj Floor-mounted
	129 087 000225	IL-XLDB-Q-24K Döner + Buzzer Rotary + Buzzer	24 V	0.9A	24 VAC/DC	67 mm	Tabana Montaj Floor-mounted
	129 087 000226	IL-XLDB-Q-48K Döner + Buzzer Rotary + Buzzer	48 V	0.9A	48 VAC/DC	67 mm	Tabana Montaj Floor-mounted
	129 087 000227	IL-XLDB-Q-110K Döner + Buzzer Rotary + Buzzer	110 V	0.9A	110 VAC/DC	67 mm	Tabana Montaj Floor-mounted
	129 087 000228	IL-XLDB-Q-220K Döner + Buzzer Rotary + Buzzer	220 V	0.9A	220 VAC/DC	67 mm	Tabana Montaj Floor-mounted
Renk Seçenekleri / Color Options: IL-XLSB-Q-12K ● IL-XLSB-Q-12S ● IL-XLSB-Q-12Y ● IL-XLSB-Q-12M ● IL-XLSB-Q-12M ○							

	129 087 000277	IL-XLS-T5-121 Sabit Işıklı With Stationary Light	12 V	0.9A	12 VAC/DC	52 mm	Tabana Montaj Floor-mounted
	129 087 000278	IL-XLS-T5-241 Sabit Işıklı With Stationary Light	24 V	0.9A	24 VAC/DC	52 mm	Tabana Montaj Floor-mounted
	129 087 000279	IL-XLS-T5-2201 Sabit Işıklı With Stationary Light	48 V	0.9A	48 VAC/DC	52 mm	Tabana Montaj Floor-mounted
	129 087 000280	IL-XLF-T5-121 Flaşörlü With Blinker	12 V	0.9A	12 VAC/DC	52 mm	Tabana Montaj Floor-mounted
	129 087 000281	IL-XLF-T5-241 Flaşörlü With Blinker	24 V	0.9A	24 VAC/DC	52 mm	Tabana Montaj Floor-mounted
	129 087 000282	IL-XLF-T5-2201 Flaşörlü With Blinker	48 V	0.9A	48 VAC/DC	52 mm	Tabana Montaj Floor-mounted
	129 087 000283	IL-XÇ-T5-121 Çakar Beacon	12 V	0.9A	12 VAC/DC	52 mm	Tabana Montaj Floor-mounted
	129 087 000284	IL-XÇ-T5-241 Çakar Beacon	24 V	0.9A	24 VAC/DC	52 mm	Tabana Montaj Floor-mounted
	129 087 000285	IL-XÇ-T5-2201 Çakar Beacon	48 V	0.9A	48 VAC/DC	52 mm	Tabana Montaj Floor-mounted
	129 087 000286	IL-XLSB-T5-121 Sabit Işıklı + Buzzer With Stationary Light + Buzzer	12 V	0.9A	12 VAC/DC	52 mm	Tabana Montaj Floor-mounted
	129 087 000287	IL-XLSB-T5-241 Sabit Işıklı + Buzzer With Stationary Light + Buzzer	24 V	0.9A	24 VAC/DC	52 mm	Tabana Montaj Floor-mounted
	129 087 000288	IL-XLSB-T5-2201 Sabit Işıklı + Buzzer With Stationary Light + Buzzer	48 V	0.9A	48 VAC/DC	52 mm	Tabana Montaj Floor-mounted
	129 087 000289	IL-XLFB-T5-121 Flaşörlü + Buzzer With Blinker + Buzzer	12 V	0.9A	12 VAC/DC	52 mm	Tabana Montaj Floor-mounted
	129 087 000290	IL-XLFB-T5-241 Flaşörlü + Buzzer With Blinker + Buzzer	24 V	0.9A	24 VAC/DC	52 mm	Tabana Montaj Floor-mounted
	129 087 000291	IL-XLFB-T5-2201 Flaşörlü + Buzzer With Blinker + Buzzer	48 V	0.9A	48 VAC/DC	52 mm	Tabana Montaj Floor-mounted
	129 087 000292	IL-XÇB-T5-124 Çakar + Buzzer Beacon + Buzzer	12 V	0.9A	12 VAC/DC	52 mm	Tabana Montaj Floor-mounted
	129 087 000293	IL-XÇB-T5-244 Çakar + Buzzer Beacon + Buzzer	24 V	0.9A	24 VAC/DC	52 mm	Tabana Montaj Floor-mounted
	129 087 000294	IL-XÇB-T5-2204 Çakar + Buzzer Beacon + Buzzer	48 V	0.9A	48 VAC/DC	52 mm	Tabana Montaj Floor-mounted
Renk Seçenekleri / Color Options: IL-XLS-T5-121 K ● IL-XLS-T5-121 S ● IL-XLS-T5-121 Y ● IL-XLS-T5-121 M ● IL-XLS-T5-121 M ○							

2 ve 3 KATLI IŞIKLI KOLONLAR

2 and 3 STOREY ILLUMINATED COLUMNS

	Kod Code	Model Models	Voltaj Voltage	Tüketim Consumptive	Ampul Lamp	Çap Diameter	Montaj Assembly	
 IL-X...-T5 Serisi	129 087 000295	IL-XLS-T5-122	Sabit Işıklı With Stationary Light	12 V	0.9A	12 VAC/DC	0 mm	Tabana Montaj Floor-mounted
	129 087 000296	IL-XLS-T5-242	Sabit Işıklı With Stationary Light	24 V	0.9A	24 VAC/DC	0 mm	Tabana Montaj Floor-mounted
	129 087 000297	IL-XLS-T5-2202	Sabit Işıklı With Stationary Light	48 V	0.9A	48 VAC/DC	0 mm	Tabana Montaj Floor-mounted
	129 087 000298	IL-XLF-T5-122	Flaşörlü With Blinker	12 V	0.9A	12 VAC/DC	52 mm	Tabana Montaj Floor-mounted
	129 087 000299	IL-XLF-T5-242	Flaşörlü With Blinker	24 V	0.9A	24 VAC/DC	52 mm	Tabana Montaj Floor-mounted
	129 087 000300	IL-XLF-T5-2202	Flaşörlü With Blinker	48 V	0.9A	48 VAC/DC	52 mm	Tabana Montaj Floor-mounted
	129 087 000301	IL-XLSB-T5-122	Sabit Işıklı + Buzzer With Stationary Light + Buzzer	12 V	0.9A	12 VAC/DC	52 mm	Tabana Montaj Floor-mounted
	129 087 000302	IL-XLSB-T5-242	Sabit Işıklı + Buzzer With Stationary Light + Buzzer	24 V	0.9A	24 VAC/DC	52 mm	Tabana Montaj Floor-mounted
	129 087 000303	IL-XLSB-T5-2202	Sabit Işıklı + Buzzer With Stationary Light + Buzzer	48 V	0.9A	48 VAC/DC	52 mm	Tabana Montaj Floor-mounted
 IL-X...-T5 Buzzer Serisi	129 087 000304	IL-XLFB-T5-122	Flaşörlü + Buzzer With Blinker + Buzzer	12 V	0.9A	12 VAC/DC	52 mm	Tabana Montaj Floor-mounted
	129 087 000305	IL-XLFB-T5-242	Flaşörlü + Buzzer With Blinker + Buzzer	24 V	0.9A	24 VAC/DC	52 mm	Tabana Montaj Floor-mounted
	129 087 000306	IL-XLFB-T5-2202	Flaşörlü + Buzzer With Blinker + Buzzer	48 V	0.9A	48 VAC/DC	52 mm	Tabana Montaj Floor-mounted
	Renk Seçenekleri / Color Options: IL-XLS-T5-122 ●●							

 IL-X...-T5 Buzzer Serisi	129 087 000307	IL-XLS-T5-123	Sabit Işıklı With Stationary Light	12 V	0.9A	12 VAC/DC	52 mm	Tabana Montaj Floor-mounted
	129 087 000308	IL-XLS-T5-243	Sabit Işıklı With Stationary Light	24 V	0.9A	24 VAC/DC	52 mm	Tabana Montaj Floor-mounted
	129 087 000309	IL-XLS-T5-2203	Sabit Işıklı With Stationary Light	48 V	0.9A	48 VAC/DC	52 mm	Tabana Montaj Floor-mounted
	129 087 000310	IL-XLF-T5-123	Flaşörlü With Blinker	12 V	0.9A	12 VAC/DC	52 mm	Tabana Montaj Floor-mounted
	129 087 000311	IL-XLF-T5-243	Flaşörlü With Blinker	24 V	0.9A	24 VAC/DC	52 mm	Tabana Montaj Floor-mounted
	129 087 000312	IL-XLF-T5-2203	Flaşörlü With Blinker	48 V	0.9A	48 VAC/DC	52 mm	Tabana Montaj Floor-mounted
	129 087 000313	IL-XLSB-T5-123	Sabit Işıklı + Buzzer With Stationary Light + Buzzer	12 V	0.9A	12 VAC/DC	52 mm	Tabana Montaj Floor-mounted
	129 087 000314	IL-XLSB-T5-243	Sabit Işıklı + Buzzer With Stationary Light + Buzzer	24 V	0.9A	24 VAC/DC	52 mm	Tabana Montaj Floor-mounted
	129 087 000315	IL-XLSB-T5-2203	Sabit Işıklı + Buzzer With Stationary Light + Buzzer	48 V	0.9A	48 VAC/DC	52 mm	Tabana Montaj Floor-mounted
 IL-X...-T5 Serisi	129 087 000316	IL-XLFB-T5-123	Flaşörlü + Buzzer With Blinker + Buzzer	12 V	0.9A	12 VAC/DC	52 mm	Tabana Montaj Floor-mounted
	129 087 000317	IL-XLFB-T5-243	Flaşörlü + Buzzer With Blinker + Buzzer	24 V	0.9A	24 VAC/DC	52 mm	Tabana Montaj Floor-mounted
	129 087 000318	IL-XLFB-T5-2203	Flaşörlü + Buzzer With Blinker + Buzzer	48 V	0.9A	48 VAC/DC	52 mm	Tabana Montaj Floor-mounted
Renk Seçenekleri / Color Options: IL-XLS-T5-123 ●●●								

4 ve 5 KATLI IŞIKLI KOLONLAR 4 and 5 STOREY ILLUMINATED COLUMNS

	Kod Code	Model Models	Voltaj Voltage	Tüketim Consumptive	Ampul Lamp	Çap Diameter	Montaj Assembly	
	129 087 000253	IL-XLS-T5-124	Sabit Işıklı With Stationary Light	12 V	0.9A	12 VAC/DC	52 mm	Tabana Montaj Floor-mounted
	129 087 000254	IL-XLS-T5-244	Sabit Işıklı With Stationary Light	24 V	0.9A	24 VAC/DC	52 mm	Tabana Montaj Floor-mounted
	129 087 000255	IL-XLS-T5-2204	Sabit Işıklı With Stationary Light	48 V	0.9A	48 VAC/DC	52 mm	Tabana Montaj Floor-mounted
	129 087 000256	IL-XLF-T5-124	Flaşörlü With Blinker	12 V	0.9A	12 VAC/DC	52 mm	Tabana Montaj Floor-mounted
	129 087 000257	IL-XLF-T5-244	Flaşörlü With Blinker	24 V	0.9A	24 VAC/DC	52 mm	Tabana Montaj Floor-mounted
	129 087 000258	IL-XLF-T5-2204	Flaşörlü With Blinker	48 V	0.9A	48 VAC/DC	52 mm	Tabana Montaj Floor-mounted
	129 087 000259	IL-XLSB-T5-124	Sabit Işıklı + Buzzer With Stationary Light + Buzzer	12 V	0.9A	12 VAC/DC	52 mm	Tabana Montaj Floor-mounted
	129 087 000260	IL-XLSB-T5-244	Sabit Işıklı + Buzzer With Stationary Light + Buzzer	24 V	0.9A	24 VAC/DC	52 mm	Tabana Montaj Floor-mounted
	129 087 000261	IL-XLSB-T5-2204	Sabit Işıklı + Buzzer With Stationary Light + Buzzer	48 V	0.9A	48 VAC/DC	52 mm	Tabana Montaj Floor-mounted
	129 087 000262	IL-XLFB-T5-124	Flaşörlü + Buzzer With Blinker + Buzzer	12 V	0.9A	12 VAC/DC	52 mm	Tabana Montaj Floor-mounted
	129 087 000263	IL-XLFB-T5-244	Flaşörlü + Buzzer With Blinker + Buzzer	24 V	0.9A	24 VAC/DC	52 mm	Tabana Montaj Floor-mounted
	129 087 000264	IL-XLFB-T5-2204	Flaşörlü + Buzzer With Blinker + Buzzer	48 V	0.9A	48 VAC/DC	52 mm	Tabana Montaj Floor-mounted
Renk Seçenekleri / Color Options: IL-XLS-T5-124 ●●●●								

	129 087 000265	IL-XLS-T5-125	Sabit Işıklı With Stationary Light	12 V	0.9A	12 VAC/DC	52 mm	Tabana Montaj Floor-mounted
	129 087 000266	IL-XLS-T5-245	Sabit Işıklı With Stationary Light	24 V	0.9A	24 VAC/DC	52 mm	Tabana Montaj Floor-mounted
	129 087 000267	IL-XLS-T5-2205	Sabit Işıklı With Stationary Light	48 V	0.9A	48 VAC/DC	52 mm	Tabana Montaj Floor-mounted
	129 087 000268	IL-XLF-T5-125	Sabit Işıklı With Stationary Light	12 V	0.9A	12 VAC/DC	52 mm	Tabana Montaj Floor-mounted
	129 087 000269	IL-XLF-T5-245	Sabit Işıklı With Stationary Light	24 V	0.9A	24 VAC/DC	52 mm	Tabana Montaj Floor-mounted
	129 087 000270	IL-XLF-T5-2205	Sabit Işıklı With Stationary Light	48 V	0.9A	48 VAC/DC	52 mm	Tabana Montaj Floor-mounted
	129 087 000271	IL-XLSB-T5-125	Sabit Işıklı + Buzzer With Stationary Light + Buzzer	12 V	0.9A	12 VAC/DC	52 mm	Tabana Montaj Floor-mounted
	129 087 000272	IL-XLSB-T5-245	Sabit Işıklı + Buzzer With Stationary Light + Buzzer	24 V	0.9A	24 VAC/DC	52 mm	Tabana Montaj Floor-mounted
	129 087 000273	IL-XLSB-T5-2205	Sabit Işıklı + Buzzer With Stationary Light + Buzzer	48 V	0.9A	48 VAC/DC	52 mm	Tabana Montaj Floor-mounted
	129 087 000274	IL-XLFB-T5-125	Flaşörlü + Buzzer With Blinker + Buzzer	12 V	0.9A	12 VAC/DC	52 mm	Tabana Montaj Floor-mounted
	129 087 000275	IL-XLFB-T5-245	Flaşörlü + Buzzer With Blinker + Buzzer	24 V	0.9A	24 VAC/DC	52 mm	Tabana Montaj Floor-mounted
	129 087 000276	IL-XLFB-T5-2205	Flaşörlü + Buzzer With Blinker + Buzzer	48 V	0.9A	48 VAC/DC	52 mm	Tabana Montaj Floor-mounted
Renk Seçenekleri / Color Options: IL-XLS-T5-125 ●●●●								

KORNALAR

HORNS

	Kod Code	Model Models	Voltaj Voltage	Ses Seviyesi Decibel	Çap Diameter	Çalışma Şekli Mode Operation	Montaj Assembly	
	129 087 000229	IL-XB-B-12	Korna Horns	12V	95dB/30 cm	67 mm	Kesik Kesik Intermittent	
	129 087 000230	IL-XB-B-24	Korna Horns	24V	95dB/30 cm	67 mm	Kesik Kesik Intermittent	
	129 087 000231	IL-XB-B-48	Korna Horns	48V	95dB/30 cm	67 mm	Kesik Kesik Intermittent	
	129 087 000232	IL-XB-B-110	Korna Horns	110V	95dB/30 cm	67 mm	Kesik Kesik Intermittent	
	129 087 000233	IL-XB-B-220	Korna Horns	220V	95dB/30 cm	67 mm	Kesik Kesik Intermittent	
	129 087 000234	IL-XB-Q-12	Korna Horns	12V	95dB/30 cm	67 mm	Kesik Kesik Intermittent	
	129 087 000235	IL-XB-Q-24	Korna Horns	24V	95dB/30 cm	67 mm	Kesik Kesik Intermittent	
	129 087 000236	IL-XB-Q-48	Korna Horns	48V	95dB/30 cm	67 mm	Kesik Kesik Intermittent	
	129 087 000237	IL-XB-Q-110	Korna Horns	110V	95dB/30 cm	67 mm	Kesik Kesik Intermittent	
	129 087 000238	IL-XB-Q-220	Korna Horns	220V	95dB/30 cm	67 mm	Kesik Kesik Intermittent	
	129 087 000239	IL-XBD-T5-12	Korna Horns	12V	65dB/30 cm	52 mm	Sürekli Sesli Continuous Voice	Tabana Montaj Floor-mounted
	129 087 000240	IL-XBD-T5-24	Korna Horns	24V	65dB/30 cm	52 mm	Sürekli Sesli Continuous Voice	Tabana Montaj Floor-mounted
	129 087 000241	IL-XBD-T5-220	Korna Horns	220V	65dB/30 cm	52 mm	Sürekli Sesli Continuous Voice	Tabana Montaj Floor-mounted
	129 087 000242	IL-XBK-T5-12	Korna Horns	12V	65dB/30 cm	52 mm	Kesik Kesik Intermittent	Tabana Montaj Floor-mounted
	129 087 000243	IL-XBK-T5-24 2	Korna Horns	24V	65dB/30 cm	52 mm	Kesik Kesik Intermittent	Tabana Montaj Floor-mounted
	129 087 000244	IL-XBK-T5-220	Korna Horns	220V	65dB/30 cm	52 mm	Kesik Kesik Intermittent	Tabana Montaj Floor-mounted
	129 087 000245	IL-XFM-12A-905AL70	Buzzer Buzzer	12V	90dB/30 cm	52 mm	Çift Ses Dual Sound	Kablolu Wired
	129 087 000246	IL-XFM-12Q-905L70	Buzzer Buzzer	12V	95dB/60 cm	52 mm	Çift Ses Dual Sound	Kablolu Wired
	129 087 000247	IL-XFM-24C-905L70	Buzzer Buzzer	24V	92dB/100 cm	52 mm	Çift Ses Dual Sound	Kablolu Wired
	129 087 000248	IL-XFM-220A-905AL70	Buzzer Buzzer	220V	95dB/30 cm	52 mm	Çift Ses Dual Sound	Kablolu Wired
	129 087 000249	IL-XFM-24C-900L700	Buzzer Buzzer	24V	92dB/100 cm	52 mm	Sürekli Sesli Continuous Voice	Kablolu Wired
	129 087 000250	IL-XFM-220A-905A	Buzzer Buzzer	12V	90dB/300 cm	52 mm	Çift Ses Dual Sound	Kablolu Wired
	129 087 000251	IL-XFM-12A-905A	Buzzer Buzzer	220V	90dB/30 cm	52 mm	Çift Ses Dual Sound	Kablolu Wired
	129 087 000252	IL-XFM-12Q-905	Buzzer Buzzer	12V	90dB/30 cm	52 mm	Çift Ses Dual Sound	Kablolu Wired

TERMOPLASTİK BUATLAR

THERMOPLASTIC JUNCTION BOXES

	Kod Code	Açıklama Description	Ambalaj Packing	Adet Quantity	Ağırlık Weight	Hacim Volume
	Alev Yaymayan Non Flammable   CE 001 046 090090 00 17	Ø 90 Termoplastik Buat Ø 90 Thermoplastic Junction Box IP40	Kutu Pack	216	12.28 Kg	0.091
	Alev Yayan Flammable 001 046 070090 00 17					
	Alev Yaymayan Non Flammable   CE 001 046 098585 00 17	85x85x48 Termoplastik Buat 85x85x48 Thermoplastic Junction Box IP40	Kutu Pack	216	21.15 Kg	0.098
	Alev Yayan Flammable 001 046 078585 00 17					
	Alev Yaymayan Non Flammable   CE 001 046 098080 00 17	80x80x48 Termoplastik 7 Çıkışlı Buat 80x80x48 Thermoplastic Junction Box with 7 outlets IP40	Kutu Pack	216	15.62 Kg	0.091
	Alev Yayan Flammable 001 046 078080 00 17					
	Alev Yaymayan Non Flammable   CE 001 046 091010 00 17	110x110x74 Termoplastik 8 Çıkışlı Buat 110x110x74 Thermoplastic Junction Box with 8 outlets IP65	Kutu Pack	90	18.22 Kg	0.140
	Alev Yayan Flammable 001 046 071010 00 17					
	Alev Yaymayan Non Flammable   CE 001 046 091118 00 17	110x180x77 Termoplastik 10 Çıkışlı Buat 110x180x77 Thermoplastic Junction Box with 10 outlets IP65	Kutu Pack	60	18.02 Kg	0.112
	Alev Yayan Flammable 001 046 071118 00 17					
	Alev Yaymayan Non Flammable   CE 001 046 091827 00 17	180x270x100 Termoplastik 14 Çıkışlı Buat 180x270x100 Thermoplastic Junction Box with 14 outlets IP65	Kutu Pack	20	15.82 Kg	0.137
	Alev Yayan Flammable 001 046 071827 00 17					









TERMOPLASTİK BUATLAR

THERMOPLASTIC JUNCTION BOXES

	Kod Code	Açıklama Description	Ambalaj Packing	Adet Quantity	Ağırlık Weight	Hacim Volume
	Alev Yayımayan Non Flammable   CE 001 046 092698 00 44	138x226x98 Şeffaf Termoplastik Buat 138x226x98 Transparent Thermoplastic Boxes	Kutu Pack	8	3.68 Kg	0.056
	Alev Yayan Flammable 001 046 072698 00 44	IP65				
	Alev Yayımayan Non Flammable   CE 001 046 096131 00 44	138x226x131 Şeffaf Termoplastik Buat 138x226x131 Transparent Thermoplastic Boxes	Kutu Pack	8	3.94 Kg	0.023
	Alev Yayan Flammable 001 046 076131 00 44	IP65				
	Alev Yayımayan Non Flammable   CE 001 046 091199 00 44	225x311x99 Şeffaf Termoplastik Buat 225x311x99 Transparent Thermoplastic Boxes	Kutu Pack	4	3.17 Kg	0.028
	Alev Yayan Flammable 001 046 071199 00 44	IP65				
	Alev Yayımayan Non Flammable   CE 001 046 091130 00 44	225x311x130 Şeffaf Termoplastik Buat 225x311x130 Transparent Thermoplastic Boxes	Kutu Pack	4	3.55 Kg	0.028
	Alev Yayan Flammable 001 046 071130 00 44	IP65				
	Alev Yayımayan Non Flammable   CE 001 046 092698 00 17	138x226x98 Termoplastik Buat 138x226x98 Thermoplastic Boxes	Kutu Pack	8	3.67 Kg	0.024
	Alev Yayan Flammable 001 046 072698 00 17	IP65				
	Alev Yayımayan Non Flammable   CE 001 046 096131 00 17	138x226x131 Termoplastik Buat 138x226x131 Thermoplastic Boxes	Kutu Pack	8	3.94 Kg	0.023
	Alev Yayan Flammable 001 046 076131 00 17	IP65				
	Alev Yayımayan Non Flammable   CE 001 046 091199 00 17	225x311x99 Termoplastik Buat 225x311x99 Thermoplastic Boxes	Kutu Pack	4	2.78 Kg	0.028
	Alev Yayan Flammable 001 046 071199 00 17	IP65				
	Alev Yayımayan Non Flammable   CE 001 046 091130 00 17	225x311x130 Termoplastik Buat 225x311x130 Thermoplastic Boxes	Kutu Pack	4	3.01 Kg	0.036
	Alev Yayan Flammable 001 046 071130 00 17	IP65				
	Alev Yayımayan Non Flammable   CE 001 046 098226 00 17	138x226x127 Kombinasyon Kutusu 138x226x127 Combination Box	Kutu Pack	8	4.51 Kg	0.032
	Alev Yayan Flammable 001 046 078226 00 17	IP65				
	Alev Yayımayan Non Flammable   CE 001 046 095311 00 17	225x311x132 Kombinasyon Kutusu 225x311x132 Combination Box	Kutu Pack	4	3.13 Kg	0.037
	Alev Yayan Flammable 001 046 075311 00 17	IP65				

KARE BUATLAR

SQUARE JUNCTION BOXES

	Kod Code	Açıklama Description	Ambalaj Packing	Adet Quantity	Ağırlık Weight	Hacim Volume
	001 046 051010 00 12 	Alev Yaymayan 10x10 Kare Buat Turuncu Non Flammable 10x10 Square Junc Orange	Kutu Pack	10	0.833 Kg	0.0061
	001 046 021010 00 12	Alev Yayan 10x10 Kare Buat Turuncu Flammable 10x10 Square Junc Orange	Kutu Pack	10	0.833 Kg	0.0061
	001 046 051212 00 12 	Alev Yaymayan 12x12 Kare Buat Turuncu Non Flammable 12x12 Square Junc Orange	Kutu Pack	10	1.02 Kg	0.0093
	001 046 021212 00 12	Alev Yayan 12x12 Kare Buat Turuncu Flammable 12x12 Square Junc Orange	Kutu Pack	10	1.02 Kg	0.0093
	001 046 051515 00 12 	Alev Yaymayan 15x15 Kare Buat Turuncu Non Flammable 15x15 Square Junc Orange	Kutu Pack	10	1.85 Kg	0.0151
	001 046 021515 00 12	Alev Yayan 15x15 Kare Buat Turuncu Flammable 15x15 Square Junc Orange	Kutu Pack	10	1.85 Kg	0.0151
	001 046 052020 00 12 	Alev Yaymayan 20x20 Kare Buat Turuncu Non Flammable 20x20 Square Junc Orange	Kutu Pack	10	2.857 Kg	0.028
	001 046 022020 00 12	Alev Yayan 20x20 Kare Buat Turuncu Flammable 20x20 Square Junc Orange	Kutu Pack	10	2.857 Kg	0.028

TESİSAT

INSTALLATION



W OTOMAT KUTULARI FUSE BOXES

MEKSBOX

TSE CE IP 30



ÖLÇÜLER (mm) DIMENSIONS

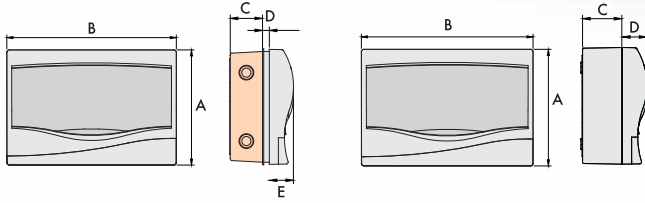

SIVAALTI W OTOMAT KUTULARI FLUSH MOUNTED FUSE BOXES

	A	B	C	D	E
2' li	142	93	53.5	11,5	40
4'lü	142	138	53.5	11,5	40
6'lı	142	163	53.5	11,5	40
9'lu	172	217	53.5	11,5	40
12'li	182	272	53.5	11,5	40
16'lı	272	207	53.5	11,5	40
24'lü	332	272	53.5	11,5	40
36'lı	482	272	53.5	11,5	40

SIVAÜSTÜ W OTOMAT KUTULARI SURFACE MOUNTED FUSE BOXES

	A	B	C	D
2' li	149	100	65	40
4'lü	150	150	65	40
6'lı	150	170	65	40
9'lu	180	225	65	40
12'li	190	280	65	40
16'lı	290	215	65	40
24'lü	340	280	65	40
36'lı	490	280	65	40

Terminal koruma seviyesi (Koruma sınıfı) Terminal protection level (Protection class)	IP 30 IP 30
Kutuların tipi Type of boxes	Dikdörtgen kutulardır. Rectangular box
Tesis sırasındaki sıcaklık aralığı Temperature range during installation	-25°C / +60°C -25°C / +60°C
Yalıtım direnci Insulation resistance	5 MΩ'un üzerindedir. Over 5 m Ohm
Yüksek gerilime dayanımı Resistance to high voltage	3750 V AC (Alternatif akım, 220 / 400 V-50 Hz) 3750 V AC (Alternating Current, 220/400 V-50 Hz)

TESİS VE UYGULAMA

Sağlam, yanmaz duvarda ve tavanda kullanıma uygundur.
İnşaat sırasında ve inşaat işleminden sonra montaja elverişlidir.

Sert, yanabilir duvarlarda ve tavanda kullanıma uygundur.

Beton içerisi hariç tüm montaj tipleri için uygundur.

Kutuların sivaüstü ve sivaaltı tespiti son derece kolay yapılabilecek şekilde tasarlanmıştır.

Kutular elektriksel korumayı sağlayacak şekilde tasarlanmıştır.

Kutuların giriş delikleri boru girişine uygundur.

Kutuların normal kullanım sürecinde oluşabilecek yaşlanma ve nemli şartlara karşı dayanıklılığı, kullanılan metal malzemelerin paslanmaya karşı dayanıklılığı, sızdırmazlık ve aşınma testleri ve elektrik çarpmasına karşı koruma testleri, ısıya dayanıklılık testleri, mekanik dayanıklılık testleri ve olağan dışı ısıya karşı dayanıklılık testleri TS EN 60670-1/ARALIK 2015 standard kapsamında yapılan yeterlilik testleri ile doğrulanmıştır.

INSTALLATION AND APPLICATION

Fuse boxes are suitable for use on sound and fireproof walls and ceilings. The fuse boxes are suitable for installation during and after construction works.

Suitable for application on solid and combustible walls and ceilings.

Suitable for all installation types except for concrete-embedded applications.

The fuse boxes are designed for easy flush-mounted and surface mounted installation.

Fuse boxes are designed to provide electrical protection.

Inlet ports of the fuse boxes are compatible for pipe installation.

The resistance of the fuse boxes against ageing and humidity conditions that might occur during normal use, resistance of the metals used against oxidation are validated by means of permeability and abrasion tests, tests for resistance to temperature, mechanical endurance tests and extraordinary heat resistance tests conducted under the scope of TS EN 60670-1/DECEMBER 2005 standard

SIVAÜSTÜ W OTOMAT KUTULARI

SURFACE MOUNTED FUSE BOXES

SIVAALTI W OTOMAT KUTULARI

FLUSH MOUNTED FUSE BOXES

  **001 027 110002 00 00** Alev Yaymayan
Non Flammable

001 027 100002 00 00 Alev Yayan
Flammable



1-2 'li Siva Üstü W Otomat Kutusu (Kapaklı)
Surface-Mounted Fuse Box (With Cover), 1-2 Fuses

Ambalaj Şekli / Package Type	Kutu / Pack
Adet / m / Quantity / m	30
Ağırlık / Weight	9.15 kg
m ³ / Volume	0.053

  **001 027 010002 00 00** Alev Yaymayan
Non Flammable

001 027 000002 00 00 Alev Yayan
Flammable



1-2 'li Siva Altı W Otomat Kutusu (Kapaklı)
Flush-Mounted Fuse Box (With Cover), 1-2 Fuses

Ambalaj Şekli / Package Type	Kutu / Pack
Adet / m / Quantity / m	30
Ağırlık / Weight	8.85 kg
m ³ / Volume	0.053

  **001 027 110004 00 00** Alev Yaymayan
Non Flammable

001 027 100004 00 00 Alev Yayan
Flammable



3-4 'lü Siva Üstü W Otomat Kutusu (Kapaklı)
Surface-Mounted Fuse Box (With Cover), 3-4 Fuses

Ambalaj Şekli / Package Type	Kutu / Pack
Adet / m / Quantity / m	20
Ağırlık / Weight	8.48 kg
m ³ / Volume	0.053

  **001 027 010004 00 00** Alev Yaymayan
Non Flammable

001 027 000004 00 00 Alev Yayan
Flammable



3-4 'lü Siva Altı W Otomat Kutusu
Flush-Mounted Fuse Box (With Cover), 3-4 Fuses

Ambalaj Şekli / Package Type	Kutu / Pack
Adet / m / Quantity / m	20
Ağırlık / Weight	7.70 kg
m ³ / Volume	0.053

  **001 027 110006 00 00** Alev Yaymayan
Non Flammable

001 027 100006 00 00 Alev Yayan
Flammable



2-6 'lı Siva Üstü W Otomat Kutusu
Surface-Mounted Fuse Box, 2-6 Fuses

Ambalaj Şekli / Package Type	Kutu / Pack
Adet / m / Quantity / m	20
Ağırlık / Weight	9.84 kg
m ³ / Volume	0.060

  **001 027 010006 00 00** Alev Yaymayan
Non Flammable

001 027 000006 00 00 Alev Yayan
Flammable



2-6 'lı Siva Altı W Otomat Kutusu
Flush-Mounted Fuse Box, 2-6 Fuses

Ambalaj Şekli / Package Type	Kutu / Pack
Adet / m / Quantity / m	20
Ağırlık / Weight	9.64 kg
m ³ / Volume	0.060

  **001 027 110009 00 00** Alev Yaymayan
Non Flammable

001 027 100009 00 00 Alev Yayan
Flammable



9 'lü Siva Üstü W Otomat Kutusu
Surface-Mounted Fuse Box, 9 Fuses

Ambalaj Şekli / Package Type	Kutu / Pack
Adet / m / Quantity / m	20
Ağırlık / Weight	13.56 kg
m ³ / Volume	0.093

  **001 027 010009 00 00** Alev Yaymayan
Non Flammable

001 027 000009 00 00 Alev Yayan
Flammable



9 'lü Siva Altı W Otomat Kutusu
Flush-Mounted Fuse Box, 9 Fuses

Ambalaj Şekli / Package Type	Kutu / Pack
Adet / m / Quantity / m	20
Ağırlık / Weight	13.40 kg
m ³ / Volume	0.093

  **001 027 110012 00 00** Alev Yaymayan
Non Flammable

001 027 100012 00 00 Alev Yayan
Flammable



12'li Siva Üstü W Otomat Kutusu
Surface-Mounted Fuse Box, 12 Fuses

Ambalaj Şekli / Package Type	Kutu / Pack
Adet / m / Quantity / m	10
Ağırlık / Weight	8.56 kg
m ³ / Volume	0.063

  **001 027 010012 00 00** Alev Yaymayan
Non Flammable

001 027 000012 00 00 Alev Yayan
Flammable



12'li Siva Altı W Otomat Kutusu
Flush-Mounted Fuse Box, 12 Fuses

Ambalaj Şekli / Package Type	Kutu / Pack
Adet / m / Quantity / m	10
Ağırlık / Weight	8.28 kg
m ³ / Volume	0.063

SIVAÜSTÜ W OTOMAT KUTULARI SURFACE MOUNTED FUSE BOXES

SIVAALTI W OTOMAT KUTULARI FLUSH MOUNTED FUSE BOXES

   001 027 110016 00 00 Alev Yaymayan
Non Flammable

001 027 100016 00 00 Alev Yayan
Flammable



16'lı Sıva Üstü W Otomat Kutusu
Surface-Mounted Fuse Box, 16 fuses

Ambalaj Şekli / Package Type	Kutu / Pack
Adet / m / Quantity / m	10
Ağırlık / Weight	10.16 kg
m ³ / Volume	0.073



   001 027 010016 00 00 Alev Yaymayan
Non Flammable

001 027 000016 00 00 Alev Yayan
Flammable



16'lı Sıva Altı W Otomat Kutusu
Flush-Mounted Fuse Box, 16 Fuses

Ambalaj Şekli / Package Type	Kutu / Pack
Adet / m / Quantity / m	10
Ağırlık / Weight	9.60 kg
m ³ / Volume	0.073



   001 027 110024 00 00 Alev Yaymayan
Non Flammable

001 027 100024 00 00 Alev Yayan
Flammable



24'lü Sıva Üstü W Otomat Kutusu
Surface-Mounted Fuse Box, 24 Fuses

Ambalaj Şekli / Package Type	Kutu / Pack
Adet / m / Quantity / m	5
Ağırlık / Weight	7.35 kg
m ³ / Volume	0.056



   001 027 010024 00 00 Alev Yaymayan
Non Flammable

001 027 000024 00 00 Alev Yayan
Flammable



24'lü Sıva Altı W Otomat Kutusu
Flush-Mounted Fuse Box, 24 Fuses

Ambalaj Şekli / Package Type	Kutu / Pack
Adet / m / Quantity / m	5
Ağırlık / Weight	7.18 kg
m ³ / Volume	0.056

   001 027 110036 00 00 Alev Yaymayan
Non Flammable

001 027 100036 00 00 Alev Yayan
Flammable



36'lı Sıva Üstü W Otomat Kutusu
36 Surface Mounted Fuse Boxes
Surface-Mounted Fuse Box, 36 Fuses

Ambalaj Şekli / Package Type	Kutu / Pack
Adet / m / Quantity / m	5
Ağırlık / Weight	10.45 kg
m ³ / Volume	0.077

   001 027 010036 00 00 Alev Yaymayan
Non Flammable

001 027 000036 00 00 Alev Yayan
Flammable





36'lı Sıva Altı W Otomat Kutusu
36 Flush Mounted Fuse Boxes
Flush-Mounted Fuse Box, 36 Fuses

Ambalaj Şekli / Package Type	Kutu / Pack
Adet / m / Quantity / m	5
Ağırlık / Weight	10.30 kg
m ³ / Volume	0.077

MEKS SERİSİ MÜHÜRLÜ SİGORTA KUTULARI MEKS SERIES SEALED FUSE BOXES



**1 'li Sıva Üstü
Mühürlü Sigorta Kutusu**
Surface Mounted Sealed
Fuse Box, 1 Fuse

001 027 210001 00 00 Alev Yaymayan
Non Flammable   

001 027 200001 00 00 Alev Yayan
Flammable

Ambalaj Şekli / Package Type	Kutu / Pack
Adet / m / Quantity / m	160
Ağırlık / Weight	9.44 Kg
m ³ / Volume	0.076



**1-2 'li Sıva Üstü
Mühürlü Sigorta Kutusu**
Surface Mounted Sealed
Fuse Box, 1-2 Fuses



001 027 210002 00 00 Alev Yaymayan
Non Flammable   

001 027 200002 00 00 Alev Yayan
Flammable

Ambalaj Şekli / Package Type	Kutu / Pack
Adet / m / Quantity / m	80
Ağırlık / Weight	6.16 Kg
m ³ / Volume	0.048



**3-4 'li Sıva Üstü
Mühürlü Sigorta Kutusu**
Surface Mounted Sealed
Fuse Box, 3-4 Fuses

001 027 210004 00 00 Alev Yaymayan
Non Flammable   

001 027 200004 00 00 Alev Yayan
Flammable

Ambalaj Şekli / Package Type	Kutu / Pack
Adet / m / Quantity / m	80
Ağırlık / Weight	8.40 Kg
m ³ / Volume	0.077

TELEFON DAĞITIM KUTULARI VE AKSESUARLARI

TELEPHONE DISTRIBUTION BOXES (HUBS) and ACCESSORIES

	Kod Code	Açıklama Description	Ambalaj Packing	Adet Quantity	Ağırlık Weight	Hacim Volume
 IP 40	Alev Yaymayan Non Flammable    001 049 201020 00 00	Telefon Dağıtım Kutusu 10-20 (Plastik Kilitli) Telephone Distribution Box, 10-20 Hubs (With Plastic Lock)	Kutu Pack	60	15 Kg	0.085
	Alev Yayan Flammable 001 049 001020 00 00					
 IP 40	Alev Yaymayan Non Flammable    001 049 211020 00 00	Telefon Dağıtım Kutusu 10-20 (Kilitli) Telephone Distribution Box, 10-20 Hubs (With Lock)	Kutu Pack	60	15.54 Kg	0.085
	Alev Yayan Flammable 001 049 011020 00 00					
 IP 40	Alev Yaymayan Non Flammable    001 049 201050 00 00	Telefon Dağıtım Kutusu 10-50 (Plastik Kilitli) Telephone Distribution Box, 10-50 Hubs (With Plastic Lock)	Kutu Pack	28	15.45 Kg	0.126
	Alev Yayan Flammable 001 049 001050 00 00					
 IP 40	Alev Yaymayan Non Flammable    001 049 211050 00 00	Telefon Dağıtım Kutusu 10-50 (Kilitli) Telephone Distribution Box, 10-50 Hubs (With Lock)	Kutu Pack	28	17.5 Kg	0.126
	Alev Yayan Flammable 001 049 011050 00 00					
	888 049 050002	Telefon Dağıtım Modülü (Kesmeli) Telephone Distribution Module (With interrupt feature)	Kutu Pack	400	23.2 Kg	0.062
	888 049 050001	Telefon Dağıtım Modülü (Kesmesiz) 10 Pairs Connection Module	Kutu Pack	400	23.2 Kg	0.062
	888 049 050003	İrtibatlama Aleti Connection Tool	Kutu Pack	100	10.5 Kg	0.0348
	031 049 040001	Dağıtım Kutusu Tek Jaklı Distribution Box (Single Jack)	Kutu Pack	1	0.023 Kg	0.000055
	031 049 040002	Dağıtım Kutusu Çift Jaklı Distribution Box (Double Jack)	Kutu Pack	1	0.025	0.000055

TELEFON DAĞITIM KUTULARI VE AKSESUARLARI

TELEPHONE DISTRIBUTION BOXES (HUBS) and ACCESSORIES

	Kod Code	Açıklama Description	Ambalaj Packing	Adet Quantity	Ağırlık Weight	Hacim Volume
	888 049 050008	Data Konnektörü Cat 6e (RJ 45) (8 Kontak Tolles) Data Connector Cat 6e (RJ 45) (8 Contacts)	Kutu Pack	600	8.93 Kg.	0.0615
	888 049 050009	Telefon Konnektörü (RJ 11/12) (6 Kontak) Telephone Connector (RJ 11/12) (8 Contacts)	Kutu Pack	200	1.34 Kg	0.0056
	888 049 050018	6P6C İkili Dağıtıcı Telefon Fişi 6P6C Dual Distributor Telephone Plug	Kutu Pack	500	15 Kg	0.03695
	888 049 050019	6P4C Paralel Dağıtıcı 6P4C Parallel Distributor	Kutu Pack	1000	7.5 Kg	0.0739

MODÜL BAĞLANTI ÇATISI MODULE CONNECTION RACK

	Kod Code	Açıklama Description	Ambalaj Packing	Adet Quantity	Ağırlık Weight	Hacim Volume
	001 024 000001 00 00	1 modül için Rack for 1 module	Kutu Pack	1000	25 Kg	0.051
	001 024 000002 00 00	2 modül için Rack for 2 modules	Kutu Pack	500	24 Kg	0.051
	001 024 000003 00 00	3 modül için Rack for 3 modules	Kutu Pack	400	27.60 Kg	0.051
	001 024 000004 00 00	4 modül için Rack for 4 modules	Kutu Pack	300	28.5 Kg	0.051
	001 024 000005 00 00	5 modül için Rack for 5 modules	Kutu Pack	200	22.94 Kg	0.051
	001 024 000006 00 00	6 modül için Rack for 6 modules	Kutu Pack	200	25.38 Kg	0.113
	001 024 000007 00 00	7 modül için Rack for 7 modules	Kutu Pack	150	23.02 Kg	0.98
	001 024 000008 00 00	8 modül için Rack for 8 modules	Kutu Pack	150	26.26 Kg	0.110
	001 024 000009 00 00	9 modül için Rack for 9 modules	Kutu Pack	100	19.79 Kg	0.086
	001 024 000010 00 00	10 modül için Rack for 10 modules	Kutu Pack	100	22.70 Kg	0.086

ÇELİK SPİRALLER PVC SPİRAL VE BORULAR

STEEL SPIRALS PVC SPIRALS AND PIPES



Flame Retardant
Alev Yaymayan



	ALEV YAYMAYAN SİRALLER NONFLAMMABLE SPIRALS	ALEV YAYAN SİRALLER FLAMMABLE SPIRALS
Boru tipi Type of the Pipe	Metalik olmayan - oluklu Nonmetallic - Corrugated	Metalik olmayan - oluklu Nonmetallic - Corrugated
Bağlantı metodu Connection method	Diş çekilmemiş Non-threaded	Diş çekilmemiş Non-threaded
Sıkıştırmaya karşı dayanıklılık Compressive Strength	Hafif (320 N) Orta (750 N) Low (320 N) Medium (750 N)	Hafif (320 N) Low (320 N)
Darbeye karşı dayanıklılık Impact Resistance	Orta (2 kg, 100 mm) -15°C'de Medium (2 kg, 100 mm) - 15°C	Orta (2 kg, 100 mm) -15°C'de Medium (2 kg, 100 mm) - 15°C
En küçük sürekli uygulama ve tesisat sıcaklığı Minimum continuous application and installation temperature	-15°C -15°C	-15°C -15°C
En büyük sürekli uygulama ve tesisat sıcaklığı Maximum continuous application and installation temperature	+60°C +60°C	+60°C +60°C
Bükülmeye karşı dayanıklılık Flexural Strength	Esnek - kendini toparlayan Flexible-Self recovering	Esnek - kendini toparlayan Flexible-Self recovering
Diş etkenlere karşı dayanıklılık Resistance to external impacts	Katı yabancı cisimlerin girişine karşı korumalı Protected against ingress of solid foreign materials	Katı yabancı cisimlerin girişine karşı korumalı Protected against ingress of solid foreign materials
Alev yayılmasına karşı dayanıklılık Resistance to flame propagation	Alev yaymayan Non-flame-propagating	Alev yayan Flammable

POLYAMİD (PA) ALEV YAYMAYAN SİRALLER POLYAMIDE (PA) NON-FLAME-PROPAGATING SPIRALS

Boru tipi Type of the Pipe	Metalik olmayan - oluklu Nonmetallic - Corrugated
Bağlantı metodu Connection method	Diş çekilmemiş Non-threaded
Sıkıştırmaya karşı dayanıklılık Compressive Strength	Hafif (320 N) Low (320 N)
Darbeye karşı dayanıklılık Impact Resistance	Hafif (1kg, 100 mm) -15°C'de Low (1 kg, 100 mm) - 15°C
En küçük sürekli uygulama ve tesisat sıcaklığı Minimum continuous application and installation temperature	-15°C -15°C
En büyük sürekli uygulama ve tesisat sıcaklığı Maximum continuous application and installation temperature	+105°C +105°C
Bükülmeye karşı dayanıklılık Flexural Strength	Esnek - kendini toparlayan Flexible-Self recovering
Diş etkenlere karşı dayanıklılık Resistance to external impacts	Katı yabancı cisimlerin girişine karşı korumalı Protected against ingress of solid foreign materials
Alev yayılmasına karşı dayanıklılık Resistance to flame propagation	Alev yaymayan Non-flame-propagating

POLİPROPİLEN (PP) ALEV YAYMAYAN SİRALLER POLYPROPYLENE (PP) NON-FLAME-PROPAGATING SPIRALS

Boru tipi Type of the Pipe	Metalik olmayan - oluklu Nonmetallic - Corrugated
Bağlantı metodu Connection method	Diş çekilmemiş Non-threaded
Sıkıştırmaya karşı dayanıklılık Compressive Strength	Hafif (320 N) Low (320 N)
Darbeye karşı dayanıklılık Impact Resistance	Hafif (1kg, 100 mm) -15°C'de Low (1 kg, 100 mm) - 15°C
En küçük sürekli uygulama ve tesisat sıcaklığı Minimum continuous application and installation temperature	-15°C -15°C
En büyük sürekli uygulama ve tesisat sıcaklığı Maximum continuous application and installation temperature	+90°C +90°C
Bükülmeye karşı dayanıklılık Flexural Strength	Esnek - kendini toparlayan Flexible-Self recovering
Diş etkenlere karşı dayanıklılık Resistance to external impacts	Katı yabancı cisimlerin girişine karşı korumalı Protected against ingress of solid foreign materials
Alev yayılmasına karşı dayanıklılık Resistance to flame propagation	Alev yaymayan Non-flame-propagating

PVC BORULAR PVC PIPES

Boru tipi Type of the Pipe	Metalik olmayan - oluklu Nonmetallic - Corrugated
Bağlantı metodu Connection method	Diş çekilmemiş Non-threaded
Sıkıştırmaya karşı dayanıklılık Compressive Strength	Orta (750 N) Medium (750 N)
Darbeye karşı dayanıklılık Impact Resistance	Orta (2 Kg, 100 mm) -15°C'de Medium (2 kg, 100 mm) - 15°C
En küçük sürekli uygulama ve tesisat sıcaklığı Minimum continuous application and installation temperature	-15°C -15°C
En büyük sürekli uygulama ve tesisat sıcaklığı Maximum continuous application and installation temperature	+60°C +60°C
Bükülmeye karşı dayanıklılık Flexural Strength	Rijit Rigit
Dış etkenlere karşı dayanıklılık Resistance to external impacts	Katı yabancı cisimlerin girişine karşı korumalı Protected against ingress of solid foreign materials
Alev yayılmasına karşı dayanıklılık Resistance to flame propagation	Alev yaymayan borular Nonflammable

ALEV YAYAN DÜZ ELEKTRİK TESİSAT BORULARI FLAME-PROPAGATING PLAIN ELECTRICAL INSTALLATION PIPE

Boru tipi Type of the Pipe	Metalik olmayan Nonmetallic - Corrugated
Bağlantı metodu Connection method	Diş çekilmemiş Non-threaded
Sıkıştırmaya karşı dayanıklılık Compressive Strength	Hafif (320 N) Orta (750 N) Low (320 N) Medium (750 N)
Darbeye karşı dayanıklılık Impact Resistance	Orta (2 Kg, 100 mm) -15°C'de Medium (2 kg, 100 mm) - 15°C
En küçük sürekli uygulama ve tesisat sıcaklığı Minimum continuous application and installation temperature	-15°C -15°C
En büyük sürekli uygulama ve tesisat sıcaklığı Maximum continuous application and installation temperature	+60°C +60°C
Bükülmeye karşı dayanıklılık Flexural Strength	Esnek - kendini toparlayan Flexible-Self recovering
Dış etkenlere karşı dayanıklılık Resistance to external impacts	Katı yabancı cisimlerin girişine karşı korumalı Protected against ingress of solid foreign materials
Alev yayılmasına karşı dayanıklılık Resistance to flame propagation	Alev yayan Flammable

ALEV YAYMAYAN DÜZ ELEKTRİK TESİSAT BORULARI NON-FLAME-PROPAGATING PLAIN ELECTRICAL INSTALLATION PIPE

Boru tipi Type	Metalik olmayan Nonmetallic - Corrugated
Bağlantı metodu Connection type	Diş çekilmemiş Non-threaded
Sıkıştırmaya karşı dayanıklılık External load resistance	Hafif (320 N) Orta (750 N) Low (320 N) Medium (750 N)
Darbeye karşı dayanıklılık Impact resistance	Orta (2 Kg, 100 mm) -15°C'de Medium (2 kg, 100 mm) - 15°C
En küçük sürekli uygulama ve tesisat sıcaklığı Starting and installation temperature minimum	-15°C -15°C
En büyük sürekli uygulama ve tesisat sıcaklığı Starting and installation temperature maximum	+60°C +60°C
Bükülmeye karşı dayanıklılık Resistance for stiffnes	Esnek - kendini toparlayan Flexible-Self recovering
Dış etkenlere karşı dayanıklılık Resistance to external materials	Katı yabancı cisimlerin girişine karşı korumalı Protected against ingress of solid foreign materials
Alev yayılmasına karşı dayanıklılık Resistance to fire	Alev yaymayan Nonflammable

ÇELİK SİRALLER STEEL SPIRALS

	Kod Code	İç Çap Inner Diameter	Dış Çap Outer Diameter	Kod Code	İç Çap Inner Diameter	Dış Çap Outer Diameter
EKO SERİSİ ÇELİK SİRALLER ECO SERIES STEEL SPIRALS				ÇELİK SİRALLER STEEL SPIRALS		
	001 054 150009 00 66	9 mm	12,10 mm	 001 054 120009 00 66	9 mm	12,10 mm
	001 054 150011 00 66	11 mm	14,10 mm	 001 054 120011 00 66	11 mm	14,10 mm
	001 054 150014 00 66	14 mm	17,10 mm	 001 054 120014 00 66	14 mm	17,10 mm
	001 054 150016 00 66	16 mm	19,10 mm	 001 054 120016 00 66	16 mm	19,10 mm
	001 054 150018 00 66	18 mm	21,10 mm	 001 054 120018 00 66	18 mm	21,10 mm
	001 054 150021 00 66	21 mm	24,10 mm	 001 054 120026 00 66	26 mm	29,10 mm
	001 054 150026 00 66	26 mm	29,10 mm	 001 054 120029 00 66	29 mm	32,10 mm
	001 054 150029 00 66	29 mm	32,10 mm	001 054 120032 00 66	32 mm	35,10 mm
	001 054 150032 00 66	32 mm	35,10 mm	 001 054 120037 00 66	37 mm	41,10 mm
	001 054 150037 00 66	37 mm	41,10 mm	 001 054 120042 00 66	42 mm	45,10 mm
	001 054 150042 00 66	42 mm	45,10 mm	 001 054 120050 00 66	50 mm	53,10 mm
	001 054 150050 00 66	50 mm	53,10 mm	001 054 120063 00 66	63 mm	66,10 mm

	Kod Code	İç Çap Inner Diameter	Dış Çap Outer Diameter	Kod Code	İç Çap Inner Diameter	Dış Çap Outer Diameter
EKO SERİSİ ÇELİK SİRALLER İÇTEN TELLİ ECO SERIES STEEL SPIRALS WITH INTERNAL WIRE				ÇELİK SİRALLER İÇTEN TELLİ STEEL SPIRALS WITH INTERNAL WIRE		
	001 054 221009 00 66	9 mm	12,10 mm	001 054 121009 00 66	9 mm	12,10 mm
	001 054 221011 00 66	11 mm	14,10 mm	001 054 121011 00 66	11 mm	14,10 mm
	001 054 221014 00 66	14 mm	17,10 mm	001 054 121014 00 66	14 mm	17,10 mm
	001 054 221016 00 66	16 mm	19,10 mm	001 054 121016 00 66	16 mm	19,10 mm
	001 054 221018 00 66	18 mm	21,10 mm	001 054 121018 00 66	18 mm	21,10 mm
	001 054 221021 00 66	21 mm	24,10 mm	001 054 121026 00 66	26 mm	29,10 mm
	001 054 221026 00 66	26 mm	29,10 mm	001 054 121029 00 66	29 mm	32,10 mm
	001 054 221029 00 66	29 mm	32,10 mm	001 054 121032 00 66	32 mm	35,10 mm
	001 054 221032 00 66	32 mm	35,10 mm	001 054 121037 00 66	37 mm	41,10 mm
	001 054 221037 00 66	37 mm	41,10 mm	001 054 121042 00 66	42 mm	45,10 mm
	001 054 221042 00 66	42 mm	45,10 mm	001 054 121050 00 66	50 mm	53,10 mm
	001 054 221050 00 66	50 mm	53,10 mm	001 054 121063 00 66	63 mm	66,10 mm

PVC İZOLELİ SPİRALLER

PVC INSULATED SPIRALS

	Kod Code	İç Çap Inner Diameter	Dış Çap Outer Diameter	Kod Code	İç Çap Inner Diameter	Dış Çap Outer Diameter
EKO SERİSİ İZOLELİ ÇELİK SPİRALLER ECO SERIES INSULATED STEEL SPIRALS				İZOLELİ ÇELİK SPİRALLER INSULATED STEEL SPIRALS		
	001 054 160009 00 11	9 mm	13,20 mm	001 054 130009 00 11	9 mm	13,20 mm
	001 054 160011 00 11	11 mm	15,20 mm	001 054 130011 00 11	11 mm	15,20 mm
	001 054 160014 00 11	14 mm	18,40 mm	001 054 130014 00 11	14 mm	18,40 mm
	001 054 160016 00 11	16 mm	20,40 mm	001 054 130016 00 11	16 mm	20,40 mm
	001 054 160018 00 11	18 mm	22,40 mm	001 054 130018 00 11	18 mm	22,40 mm
	001 054 160021 00 11	21 mm	25,40 mm	001 054 130026 00 11	26 mm	30,40 mm
	001 054 160026 00 11	26 mm	30,40 mm	001 054 130029 00 11	29 mm	33,40 mm
	001 054 160029 00 11	29 mm	33,40 mm	001 054 130032 00 11	32 mm	36,40 mm
	001 054 160032 00 11	32 mm	36,40 mm	001 054 130037 00 11	37 mm	42,40 mm
	001 054 160037 00 11	37 mm	42,40 mm	001 054 130042 00 11	42 mm	46,40 mm
	001 054 160042 00 11	42 mm	46,40 mm	001 054 130050 00 11	50 mm	54,40 mm
	001 054 160050 00 11	50 mm	54,40 mm	001 054 130063 00 11	63 mm	67,20 mm



EKO SERİSİ İZOLELİ ÇELİK SPİRALLER İÇTEN TELLİ

ECO SERIES INSULATED STEEL SPIRALS WITH INTERNAL WIRE

İZOLELİ ÇELİK SPİRALLER İÇTEN TELLİ

INSULATED STEEL SPIRALS WITH INTERNAL WIRE

	001 054 231009 00 11	9 mm	13,20 mm	001 054 140009 00 11	9 mm	13,20 mm
	001 054 231011 00 11	11 mm	15,20 mm	001 054 140011 00 11	11 mm	15,20 mm
	001 054 231014 00 11	14 mm	18,40 mm	001 054 140014 00 11	14 mm	18,40 mm
	001 054 231016 00 11	16 mm	20,40 mm	001 054 140016 00 11	16 mm	20,40 mm
	001 054 231018 00 11	18 mm	22,40 mm	001 054 140018 00 11	18 mm	22,40 mm
	001 054 231021 00 11	21 mm	25,40 mm	001 054 140026 00 11	26 mm	30,40 mm
	001 054 231026 00 11	26 mm	30,40 mm	001 054 140029 00 11	29 mm	33,40 mm
	001 054 231029 00 11	29 mm	33,40 mm	001 054 140032 00 11	32 mm	36,40 mm
	001 054 231032 00 11	32 mm	36,40 mm	001 054 140037 00 11	37 mm	42,40 mm
	001 054 231037 00 11	37 mm	42,40 mm	001 054 140042 00 11	42 mm	46,40 mm
	001 054 231042 00 11	42 mm	46,40 mm	001 054 140050 00 11	50 mm	54,40 mm
	001 054 231050 00 11	50 mm	54,40 mm	001 054 140063 00 11	63 mm	67,20 mm



PVC SPİRALLER

PVC SPIRALS



Kod Code	İç Çap Inner Diameter	Dış Çap Outer Diameter
-------------	--------------------------	---------------------------

PVC ALEV YAYMAYAN SPİRALLER (FLEXI MEKS)

PVC NON-FLAME-PROPAGATING SPIRALS (FLEXI MEKS)

	001 020 000016 00 17	11,20 mm	15,85 mm
	001 020 000020 00 17	14,40 mm	19,85 mm
	001 020 000025 00 17	18,10 mm	24,80 mm
	001 020 000032 00 17	25,90 mm	31,80 mm

PVC ALEV YAYMAYAN KLAVUZ TELLİ SPİRALLER (FLEXI MEKS)

PVC NON-FLAME-PROPAGATING SPIRALS WITH GUIDE WIRE (FLEXI MEKS)

	001 020 100016 00 17	11,20 mm	15,85 mm
	001 020 100020 00 17	14,40 mm	19,85 mm
	001 020 100025 00 17	18,10 mm	24,80 mm
	001 020 100032 00 17	25,90 mm	31,80 mm

HALOJEN FREE SPİRALLER 320 N

HALOGEN-FREE SPIRALS 320 N

	Kod Code	İç Çap Inner Diameter	Dış Çap Outer Diameter
--	-------------	--------------------------	---------------------------



HALOJEN FREE SPİRAL ALEV YAYAN 320 N

HALOGEN FREE SPIRALS (FLAME-PROPAGATING) 320 N

 	001 020 140016 00 12	11,20 mm	15,85 mm
	001 020 140020 00 12	14,40 mm	19,85 mm
	001 020 140025 00 12	18,10 mm	24,80 mm
	001 020 140032 00 12	25,90 mm	31,80 mm
	001 020 140040 00 12	36 mm	39,80 mm
	001 020 140050 00 12	44 mm	49,60 mm

HALOJEN FREE SPİRAL ALEV YAYAN KILAVUZ TELLİ 320 N

HALOGEN FREE SPIRALS (FLAME-PROPAGATING) WITH GUIDE WIRE 320 N

 	001 020 141016 00 12	11,20 mm	15,85 mm
	001 020 141020 00 12	14,40 mm	19,85 mm
	001 020 141025 00 12	18,10 mm	24,80 mm
	001 020 141032 00 12	25,90 mm	31,80 mm
	001 020 141040 00 12	36 mm	39,80 mm
	001 020 141050 00 12	44 mm	49,60 mm

HALOJEN FREE SPİRAL ALEV YAYMAYAN 320 N

HALOGEN FREE SPIRALS (NON-FLAME-PROPAGATING) 320 N

 	001 020 150016 00 17	11,20 mm	15,85 mm
	001 020 150020 00 17	14,40 mm	19,85 mm
	001 020 150025 00 17	18,10 mm	24,80 mm
	001 020 150032 00 17	25,90 mm	31,80 mm
	001 020 150040 00 17	36 mm	39,80 mm
	001 020 150050 00 17	44 mm	49,75 mm

HALOJEN FREE SPİRAL ALEV YAYMAYAN KILAVUZ TELLİ 320 N

HALOGEN FREE SPIRALS (NON-FLAME-PROPAGATING) WITH GUIDE WIRE 320 N

 	001 020 151016 00 17	11,20 mm	15,85 mm
	001 020 151020 00 17	14,40 mm	19,85 mm
	001 020 151025 00 17	18,10 mm	24,80 mm
	001 020 151032 00 17	25,90 mm	31,80 mm
	001 020 151040 00 17	36 mm	39,80 mm
	001 020 151050 00 17	44 mm	49,75 mm

HALOJEN FREE SPİRALLER 750 N

HALOGEN-FREE SPIRALS 750 N

	Kod Code	İç Çap Inner Diameter	Dış Çap Outer Diameter
--	-------------	--------------------------	---------------------------

HALOJEN FREE SPİRAL ALEV YAYAN 750 N

HALOGEN FREE SPIRALS (FLAME-PROPAGATING) 750 N

 TSE CE	001 020 740016 00 12	10.3 mm	15,85 mm
	001 020 740020 00 12	14.5 mm	19,85 mm
	001 020 740025 00 12	18.7 mm	24,80 mm
	001 020 740032 00 12	24.2 mm	31,80 mm

HALOJEN FREE SPİRAL ALEV YAYAN KILAVUZ TELLİ 750 N

HALOGEN FREE SPIRALS (FLAME-PROPAGATING) WITH GUIDE WIRE 750 N

 TSE CE	001 020 741016 00 12	10.3 mm	15,85 mm
	001 020 741020 00 12	14.5 mm	19,85 mm
	001 020 741025 00 12	18.7 mm	24,80 mm
	001 020 741032 00 12	24.2 mm	31,80 mm

HALOJEN FREE SPİRAL ALEV YAYMAYAN 750 N

HALOGEN FREE SPIRALS (NON-FLAME-PROPAGATING) 750 N

 TSE CE	001 020 750016 00 17	10.3 mm	15,85 mm
	001 020 750020 00 17	14.5 mm	19,85 mm
	001 020 750025 00 17	18.7 mm	24,80 mm
	001 020 750032 00 17	24.2 mm	31,80 mm

HALOJEN FREE SPİRAL ALEV YAYMAYAN KILAVUZ TELLİ 750 N

HALOGEN FREE SPIRALS (NON-FLAME-PROPAGATING) WITH GUIDE WIRE 750 N

 TSE CE	001 020 751016 00 17	10.3 mm	15,85 mm
	001 020 751020 00 17	14.5 mm	19,85 mm
	001 020 751025 00 17	18.7 mm	24,80 mm
	001 020 751032 00 17	24.2 mm	31,80 mm

HALOJEN FREE SİRALLER 1250 N

HALOGEN-FREE SPIRALS 1250 N

	Kod Code	İç Çap Inner Diameter	Dış Çap Outer Diameter
--	-------------	--------------------------	---------------------------



HALOJEN FREE SİRAL ALEV YAYAN 1250 N

HALOGEN FREE SPIRALS (FLAME-PROPAGATING) 1250 N

 	001 020 240016 00 12	10.0 mm	15,85 mm
	001 020 240020 00 12	14.0 mm	19,85 mm
	001 020 240025 00 12	18.4 mm	24,80 mm
	001 020 240032 00 12	24.0 mm	31,80 mm

HALOJEN FREE SİRAL ALEV YAYAN KILAVUZ TELLİ 1250 N

HALOGEN FREE SPIRALS (FLAME-PROPAGATING) WITH GUIDE WIRE 1250 N

 	001 020 241016 00 12	10.0 mm	15,85 mm
	001 020 241020 00 12	14.0 mm	19,85 mm
	001 020 241025 00 12	18.4 mm	24,80 mm
	001 020 241032 00 12	24.0 mm	31,80 mm

HALOJEN FREE SİRAL ALEV YAYMAYAN 1250 N

HALOGEN FREE SPIRALS (NON-FLAME-PROPAGATING) 1250 N

  	001 020 250016 00 17	10.0 mm	15,85 mm
	001 020 250020 00 17	14.0 mm	19,85 mm
	001 020 250025 00 17	18.4 mm	24,80 mm
	001 020 250032 00 17	24.0 mm	31,80 mm

HALOJEN FREE SİRAL ALEV YAYMAYAN KILAVUZ TELLİ 1250 N

HALOGEN FREE SPIRALS (NON-FLAME-PROPAGATING) WITH GUIDE WIRE 1250 N

  	001 020 251016 00 17	10.0 mm	15,85 mm
	001 020 251020 00 17	14.0 mm	19,85 mm
	001 020 251025 00 17	18.4 mm	24,80 mm
	001 020 251032 00 17	24.0 mm	31,80 mm

PLASTİK SİRİRAL BORULAR

PLASTIC SPIRAL PIPES

	Kod Code	İç Çap Inner Diameter	Dış Çap Outer Diameter
--	-------------	--------------------------	---------------------------

PLASTİK SİRİRALER

PLASTIC SPIRALS

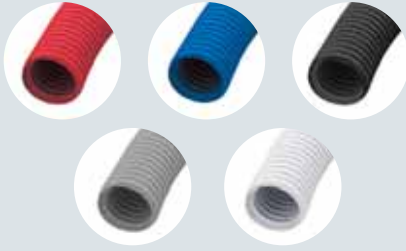

001 020 400014 00 11	15,60 mm	19,05 mm
001 020 400016 00 11	11,20 mm	15,85 mm
001 020 400018 00 11	19,60 mm	24 mm
001 020 400020 00 11	14,40 mm	19,85 mm
001 020 400026 00 11	26,10 mm	30,75 mm
001 020 400032 00 11	25,90 mm	31,80 mm
001 020 400040 00 11	36 mm	39,80 mm
001 020 400050 00 11	45,50 mm	49,75 mm

PLASTİK SİRİRALER KLAVUZ TELLİ

PLASTIC SPIRAL WITH GUIDE WIRE



001 020 410014 00 11	15,60 mm	19,05 mm
001 020 410016 00 11	11,20 mm	15,85 mm
001 020 410018 00 11	19,60 mm	24 mm
001 020 410020 00 11	14,40 mm	19,85 mm
001 020 410026 00 11	26,10 mm	30,75 mm
001 020 410032 00 11	25,90 mm	31,80 mm
001 020 410040 00 11	36 mm	39,80 mm
001 020 410050 00 11	45,50 mm	49,75 mm

POLYAMİD SİRİRALER

POLYAMIDE SPIRALS

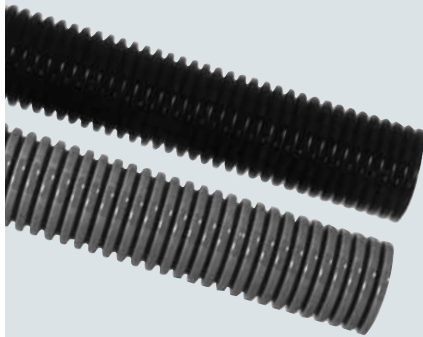

001 020 170007 00 17	7 mm	10,10 mm
001 020 170009 00 17	8,50 mm	12 mm
001 020 170010 00 17	10,20 mm	13,10 mm
001 020 170012 00 17	12,30 mm	15,90 mm
001 020 170014 00 17	14,10 mm	18,35 mm
001 020 170017 00 17	17 mm	21,50 mm
001 020 170019 00 17	19 mm	24,25 mm
001 020 170023 00 17	23 mm	28,70 mm
001 020 170026 00 17	26,20 mm	31,30 mm
001 020 170029 00 17	29,10 mm	34,30 mm
001 020 170036 00 17	35,75 mm	42,20 mm
001 020 170048 00 17	48,50 mm	54,50 mm

POLİPROPİLEN SİRİRALER

POLYPROPYLENE SPIRALS

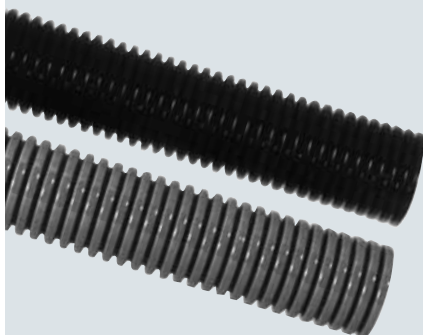

001 020 160007 00 17	6,50 mm	10 mm
001 020 160009 00 17	8,50 mm	12 mm
001 020 160010 00 17	10 mm	13 mm
001 020 160012 00 17	12 mm	16 mm
001 020 160014 00 17	14 mm	18,50 mm
001 020 160017 00 17	17 mm	21,50 mm
001 020 160019 00 17	19 mm	24 mm
001 020 160023 00 17	23 mm	28,70 mm
001 020 160026 00 17	26 mm	31 mm
001 020 160029 00 17	29 mm	34,5 mm
001 020 160036 00 17	36 mm	42,5 mm
001 020 160048 00 17	48 mm	54,5 mm

PLASTİK SİRAL BORU AKSESUARLARI

PLASTIC SPIRAL PIPES ACCESSORIES

	Kod Code	İç Çap Inner Diameter	Dış Çap Outer Diameter
KABLO TOPLAMA SİRALI CABLE ORGANIZER SPIRAL			
	888 020 900001	10 mm	
	888 020 900002	16 mm	Aksesuar
	888 020 900003	16 mm	
	888 020 900004	16 mm	
	888 020 900005	22 mm	
	888 020 900006	22 mm	Aksesuar
	888 020 900007	22 mm	
	888 020 900008	28 mm	Aksesuar
	888 020 900009	28 mm	
	888 020 900010	28 mm	
	888 020 900011	34 mm	

SİRAL BİRLEŞTİRİCİ

SPIRAL COUPLER

	001 020 990016 00 17	16 mm	
	001 020 990020 00 17	20 mm	
	001 020 990025 00 17	25 mm	
	001 020 990032 00 17	32 mm	

HELEZON PANO SİRALI

HELICOID PANEL SPIRAL

Ürün Adı
Product Name

Boy
Size

Adet
Quantity

	001 020 500000 05 00	No:0	50 cm	100
	001 020 500001 05 00	No:1	50 cm	100
	001 020 500002 05 00	No:2	50 cm	100
	001 020 500003 05 00	No:3	50 cm	100
	001 020 500004 05 00	No:4	50 cm	50
	001 020 500005 05 00	No:5	50 cm	50

HELEZON PANO SİRALI (RULO)

HELICOID PANEL SPIRAL (ROLL)

Ürün Adı
Product Name

Adet Boyu
Quantity Size

	001 020 600001 00 00	No:1	100 mt. Rulo
	001 020 600002 00 00	No:2	100 mt. Rulo
	001 020 600003 00 00	No:3	100 mt. Rulo
	001 020 600004 00 00	No:4	100 mt. Rulo
	001 020 600005 00 00	No:5	100 mt. Rulo

HALOJEN FREE RİJİT ALEV YAYMAYAN BORULAR

HALOGEN FREE NON-FLAME-PROPAGATING RIJIT PIPES

	Kod Code	İç Çap Inner Diameter	Dış Çap (+0,-0.3) Outer Diameter
--	-------------	--------------------------	-------------------------------------

HALOJEN FREE ALEV YAYMAYAN BORULAR - 320 N

HALOGEN FREE NON-FLAME-PROPAGATING PIPES - 320 N

   	001 045 500016 30 17	12.4 mm	16 mm
	001 045 500020 30 17	16.6 mm	20 mm
	001 045 500025 30 17	20.6 mm	25 mm
	001 045 500032 30 17	28.8 mm	32 mm
	001 045 500040 30 17	36.7 mm	40 mm
	001 045 500050 30 17	42.9 mm	50 mm

HALOJEN FREE ALEV YAYMAYAN BORULAR - 750 N

HALOGEN FREE NON-FLAME-PROPAGATING PIPES - 750 N

   	001 045 510016 30 17	12.4 mm	16 mm
	001 045 510020 30 17	16.0 mm	20 mm
	001 045 510025 30 17	20.6 mm	25 mm
	001 045 510032 30 17	26.8 mm	32 mm
	001 045 510040 30 17	33.9 mm	40 mm
	001 045 510050 30 17	42.9 mm	50 mm





HALOJEN FREE ALEV YAYMAYAN BORULAR - 1250 N

HALOGEN FREE NON-FLAME-PROPAGATING PIPES - 1250 N

   	001 045 520016 30 17	12.1 mm	16 mm
	001 045 520020 30 17	15.2 mm	20 mm
	001 045 520025 30 17	20.0 mm	25 mm
	001 045 520032 30 17	25.9 mm	32 mm
	001 045 520040 30 17	32.3 mm	40 mm
	001 045 520050 30 17	42.0 mm	50 mm

PVC ALEV YAYMAYAN BORULAR 750 N

PVC NON-FLAME-PROPAGATING PIPES 750 N

 	001 045 120014 30 17	11,80 mm	14 mm
	 001 045 120016 30 17	12,80 mm	16 mm
	001 045 120018 30 17	16,50 mm	18 mm
	 001 045 120020 30 17	16,70 mm	20 mm
	 001 045 120025 30 17	21,90 mm	25 mm
	 001 045 120032 30 17	29 mm	32 mm
	 001 045 120040 30 17	37,40 mm	40 mm

PVC ALEV YAYMAYAN BORULAR

PVC NON-FLAME-PROPAGATING PIPES

	Kod Code	İç Çap Inner Diameter	Dış Çap (+0,-0.3) Outer Diameter
--	-------------	--------------------------	-------------------------------------

PVC KENDİNDEN MUFLU ALEV YAYMAYAN BORULAR 750 N

PVC SELF FITTING NON-FLAME-PROPAGATING PIPES 750 N

	001 045 110014 30 17	11,80 mm	14 mm
	 CE 001 045 110016 30 17	12,80 mm	15,90 mm
	001 045 110018 30 17	15,50 mm	18 mm
	 CE 001 045 110020 30 17	16,70 mm	19,90 mm
	 CE 001 045 110025 30 17	21,90 mm	24,80 mm
	 CE 001 045 110032 30 17	29 mm	31,89mm
	001 045 110040 30 17	37,40 mm	39,89 mm



DİRSEKLER

BRACKETS

	001 051 010014 00 17		
	001 051 010016 00 17		
	001 051 010018 00 17		
	001 051 010020 00 17		
	001 051 010025 00 17		
	001 051 010032 00 17		

MUFLAR

PIPE SOCKETS

	001 051 030014 00 17		
	001 051 030016 00 17		
	001 051 030018 00 17		
	001 051 030020 00 17		
	001 051 030025 00 17		
	001 051 030032 00 17		
	001 051 030040 00 17		





SİBOR SERİSİ HALOJEN FREE TURUNCU BORULAR

SİBOR SERIES HALOGEN FREE ORANGE PIPES

	Kod Code	İç Çap Inner Diameter	Dış Çap (+0,-0.3) Outer Diameter
--	-------------	--------------------------	-------------------------------------



SİBOR SERİSİ 6 ATÜ ALEV YAYAN 125 N

SİBOR SERIES 6 ATU FLAME-PROPAGATING 125 N

 	001 165 706014 00 12	10.4 mm	14 mm
	001 165 706016 00 12	12.4 mm	16 mm
	001 165 706018 00 12	14.6 mm	18 mm
	001 165 706020 00 12	16.6 mm	20 mm
	001 165 706025 00 12	20.6 mm	25 mm
	001 165 706032 00 12	28.8 mm	32 mm
	001 165 706037 00 12	33.6 mm	37 mm
	001 165 706040 00 12	36.7 mm	40 mm
	001 165 706050 00 12	42.9 mm	50 mm

SİBOR SERİSİ 6 ATÜ ALEV YAYMAYAN 125 N

SİBOR SERIES 6 ATU NON-FLAME-PROPAGATING 125 N

  	001 165 206014 00 12	10.4 mm	14 mm
	001 165 206016 00 12	12.4 mm	16 mm
	001 165 206018 00 12	14.6 mm	18 mm
	001 165 206020 00 12	16.6 mm	20 mm
	001 165 206025 00 12	20.6 mm	25 mm
	001 165 206032 00 12	28.8 mm	32 mm
	001 165 206037 00 12	33.6 mm	37 mm
	001 165 206040 00 12	36.7 mm	40 mm
	001 165 206050 00 12	42.9 mm	50 mm



SİBOR SERİSİ 10 ATÜ ALEV YAYAN 320 N

SİBOR SERIES 10 ATU FLAME-PROPAGATING 320 N

 	001 165 710014 00 12	9.4 mm	14 mm
	001 165 710016 00 12	12.4 mm	16 mm
	001 165 710018 00 12	13.6 mm	18 mm
	001 165 710020 00 12	16.0 mm	20 mm
	001 165 710025 00 12	20.6 mm	25 mm
	001 165 710032 00 12	26.8 mm	32 mm
	001 165 710037 00 12	33.6 mm	37 mm
	001 165 710040 00 12	33.9 mm	40 mm
	001 165 710050 00 12	42.9 mm	50 mm























SİBOR SERİSİ 10 ATÜ ALEV YAYMAYAN 320 N

SİBOR SERIES 10 ATU NON-FLAME-PROPAGATING 320 N

  	001 165 210014 00 12	9.4 mm	14 mm
	001 165 210016 00 12	12.4 mm	16 mm
	001 165 210018 00 12	13.6 mm	18 mm
	001 165 210020 00 12	16.0 mm	20 mm
	001 165 210025 00 12	20.6 mm	25 mm
	001 165 210032 00 12	26.8 mm	32 mm
	001 165 210037 00 12	33.6 mm	37 mm
	001 165 210040 00 12	33.9 mm	40 mm
	001 165 210050 00 12	42.9 mm	50 mm

POLİETİLEN HALOJEN FREE BORULAR

POLYETHYLENE HALOGEN-FREE PIPES

	Kod Code	İç Çap Inner Diameter	Dış Çap Outer Diameter	
6 ATÜ ALEV YAYAN - 320 N 6 ATU FLAME-PROPAGATING - 320 N				
  	001 165 506014 00 12	11,25 mm	14,50 mm	
	 001 165 506016 00 12	12,65 mm	15,85 mm	
	001 165 506018 00 12	14,60 mm	18 mm	
	 001 165 506020 00 12	16,45 mm	19,85 mm	
	 001 165 506025 00 12	20,80 mm	24,80 mm	
	 001 165 506032 00 12	26,80 mm	31,80 mm	
	001 165 506037 00 12	30,80 mm	36,80 mm	
	 001 165 506040 00 12	33,90 mm	39,80 mm	
	 001 165 506050 00 12	42,90 mm	49,75 mm	
	 001 165 506063 00 12	55,30 mm	62,70 mm	
	 001 165 506075 00 12	66 mm	74,70 mm	
	001 165 506090 00 12	81,80 mm	90,85 mm	
	10 ATÜ ALEV YAYAN - 750 N 10 ATU FLAME-PROPAGATING - 750 N			
	  	001 165 510014 00 12	10,70 mm	14,45 mm
 001 165 510016 00 12		12 mm	15,85 mm	
001 165 510018 00 12		14,60 mm	18 mm	
 001 165 510020 00 12		15,15 mm	19,85 mm	
 001 165 510025 00 12		19,80 mm	24,80 mm	
 001 165 510032 00 12		25,25 mm	31,80 mm	
001 165 510037 00 12		29,50 mm	36,80 mm	
 001 165 510040 00 12		32,30 mm	39,80 mm	
 001 165 510050 00 12		42 mm	49,75 mm	
 001 165 510063 00 12		52,90 mm	62,70 mm	
 001 165 510075 00 12		64,30 mm	74,70 mm	
001 165 510090 00 12		78,80 mm	90,85 mm	
001 165 510100 00 12		89,90 mm	100,95 mm	
001 165 510110 00 12		95 mm	111 mm	

POLİETİLEN HALOJEN FREE BORULAR POLYETHYLENE HALOGEN-FREE PIPES

	Kod Code	İç Çap Inner Diameter	Dış Çap Outer Diameter
--	-------------	--------------------------	---------------------------

6 ATÜ ALEV YAYMAYAN - 320 N 6 ATU NON-FLAME-PROPAGATING - 320 N

 		001 165 106014 00 12	11,25 mm	14,50 mm
		001 165 106016 00 12	12,65 mm	15,85 mm
		001 165 106018 00 12	14,60 mm	18 mm
		001 165 106020 00 12	16,45 mm	19,85 mm
		001 165 106025 00 12	20,80 mm	24,80 mm
		001 165 106032 00 12	26,80 mm	31,80 mm
		001 165 106037 00 12	30,80 mm	36,80 mm
		001 165 106040 00 12	33,90 mm	39,80 mm
		001 165 106050 00 12	42,90 mm	49,75 mm
		001 165 106063 00 12	55,30 mm	62,70 mm
		001 165 106075 00 12	66 mm	74,70 mm
		001 165 106090 00 12	81,80 mm	90,85 mm

10 ATÜ ALEV YAYMAYAN - 750 N 10 ATU NON-FLAME-PROPAGATING - 750 N

 		001 165 110014 00 12	10,70 mm	14,45 mm
		001 165 110016 00 12	12 mm	15,85 mm
		001 165 110018 00 12	14,60 mm	18 mm
		001 165 110020 00 12	15,15 mm	19,85 mm
		001 165 110025 00 12	19,80 mm	24,80 mm
		001 165 110032 00 12	25,25 mm	31,80 mm
		001 165 110037 00 12	29,50 mm	36,80 mm
		001 165 110040 00 12	32,30 mm	39,80 mm
		001 165 110050 00 12	42 mm	49,75 mm
		001 165 110063 00 12	52,90 mm	62,70 mm
		001 165 110075 00 12	64,30 mm	74,70 mm
		001 165 110090 00 12	78,80 mm	90,85 mm
		001 165 110100 00 12	89,90 mm	100,95 mm
		001 165 110110 00 12	95 mm	111 mm

POLİETİLEN HALOJEN FREE BORULAR

POLYETHYLENE HALOGEN-FREE PIPES

	Kod Code	İç Çap Inner Diameter	Dış Çap Outer Diameter
ALEV YAYAN - 1250 N FLAME-PROPAGATING - 1250 N			
  	001 165 512014 00 12	9,25 mm	14,50 mm
	 001 165 512016 00 12	10,70 mm	15,85 mm
	001 165 512018 00 12	12,60 mm	18 mm
	 001 165 512020 00 12	14,50 mm	19,85 mm
	 001 165 512025 00 12	18,00 mm	24,80 mm
	 001 165 512032 00 12	25,80 mm	31,80 mm
	001 165 512037 00 12	30,80 mm	36,80 mm
	 001 165 512040 00 12	33,90 mm	39,80 mm
	 001 165 512050 00 12	43,50 mm	49,75 mm
	 001 165 512063 00 12	52,90 mm	62,70 mm
	 001 165 512075 00 12	64,30 mm	74,70 mm
	001 165 512090 00 12	79,80 mm	90,00 mm

ALEV YAYMAYAN - 1250 N NON-FLAME-PROPAGATING - 1250 N			
   	001 165 112014 00 12	9,25 mm	14,45 mm
	 001 165 112016 00 12	10,70 mm	15,85 mm
	001 165 112018 00 12	12,60 mm	18 mm
	 001 165 112020 00 12	14,50 mm	19,85 mm
	 001 165 112025 00 12	18,00 mm	24,80 mm
	 001 165 112032 00 12	25,80 mm	31,80 mm
	001 165 112037 00 12	30,80 mm	36,80 mm
	 001 165 112040 00 12	33,90 mm	39,80 mm
	 001 165 112050 00 12	43,50 mm	49,75 mm
	 001 165 112063 00 12	52,90 mm	62,70 mm
	 001 165 112075 00 12	64,30 mm	74,70 mm
	001 165 112090 00 12	79,80 mm	90,00 mm

POLİETİLEN SİYAH BORULAR

POLYETHYLENE BLACK PIPES

	Kod Code	İç Çap Inner Diameter	Dış Çap Outer Diameter
--	-------------	--------------------------	---------------------------

6 ATÜ 450 N

6 ATU 450 N

	001 165 406014 00 11	11,50 mm	14,65 mm
	001 165 406016 00 11	12,75 mm	15,85 mm
	001 165 406018 00 11	14,70 mm	18,10 mm
	001 165 406020 00 11	16,25 mm	19,85 mm
	001 165 406025 00 11	20,79 mm	24,80 mm
	001 165 406032 00 11	26,80 mm	31,80 mm
	001 165 406037 00 11	30,75 mm	36,80 mm
	001 165 406040 00 11	33,90 mm	39,80 mm
	001 165 406050 00 11	42,90 mm	49,75 mm
	001 165 406063 00 11	55,30 mm	62,70 mm
	001 165 406075 00 11	66 mm	74,70 mm
	001 165 406090 00 11	81,80 mm	90,85 mm

10 ATÜ 750 N

10 ATU 750 N

	001 165 410014 00 11	10,50 mm	14,45mm
	001 165 410016 00 11	12 mm	15,85 mm
	001 165 410018 00 11	14,30 mm	18,10 mm
	001 165 410020 00 11	15,30 mm	19,85 mm
	001 165 410025 00 11	19,80 mm	24,80 mm
	001 165 410032 00 11	25,80 mm	31,80 mm
	001 165 410037 00 11	29,50 mm	36,80 mm
	001 165 410040 00 11	32,30 mm	39,80 mm
	001 165 410050 00 11	42 mm	49,75 mm
	001 165 410063 00 11	52,90 mm	62,70 mm
	001 165 410075 00 11	64,30 mm	74,70 mm
	001 165 410090 00 11	78,80 mm	90,85 mm
	001 165 410100 00 11	89,90 mm	100,95 mm
	001 165 410110 00 11	95 mm	111 mm

PLASTİK BORULAR

PLASTIC PIPES

	001 045 000014 30 00	14 mm Kalın Boy Boru	14 mm Thick Pipes
	001 045 000018 30 00	18 mm Kalın Boy Boru	18 mm Thick Pipes
	001 045 000026 30 00	26 mm Kalın Boy Boru	26 mm Thick Pipes
	001 045 000037 30 00	37 mm Kalın Boy Boru	37 mm Thick Pipes
	001 045 010014 00 11	14 mm Kagal (Normal)	14 mm Coil (Normal)
	001 045 010018 00 11	18 mm Kagal (Normal)	18 mm Coil (Normal)
	001 045 010026 00 11	26 mm Kagal (Normal)	26 mm Coil (Normal)
	001 045 010037 00 11	37 mm Kagal (Normal)	37 mm Coil (Normal)

KAUÇUK BORULAR

RUBBER PIPES

	001 045 020014 00 00	14 mm Kagal (Kauçuk)	14 mm Coil (Rubber)
	001 045 020018 00 00	18 mm Kagal (Kauçuk)	18 mm Coil (Rubber)
	001 045 020026 00 00	26 mm Kagal (Kauçuk)	26 mm Coil (Rubber)
	001 045 020037 00 00	37 mm Kagal (Kauçuk)	37 mm Coil (Rubber)
	001 045 030014 00 00	14 mm Kagal (Kauçuk) (Kalın)	14 mm Coil (Rubber) (Thick)
	001 045 030018 00 00	18 mm Kagal (Kauçuk) (Kalın)	18 mm Coil (Rubber) (Thick)

SUSTALAR VE BUAT KAPAKLARI

CABLE PULLERS AND JUNCTION BOX COVERS

	Kod Code	Açıklama Description	Ambalaj Packing	Adet Quantity	Ağırlık Weight	Hacim Volume
--	-------------	-------------------------	--------------------	------------------	-------------------	-----------------

LÜX BUAT KAPAKLARI

LUX JUNCTION BOX COVERS

	126 046 180002	Lüx Buat Kapağı (Sac Ayak) Bombeli Lux Junction Box Cover (Sheet Trivet) Curved	Kutu Pack	500	8.5 Kg	0.195
	126 046 180003	Lüx Buat Kapağı (Plastik Ayak) Düz Lux Junction Box Cover (Plastic Trivet) Flat	Kutu Pack	500	6 Kg	0.195
	126 046 180004	L. B. K. (Bombeli - Pls. Ayak) Demir Vidalı 1. Kalite Lux Junction Box Cover (Curved-Plastic Trivet) Iron Screw, Premium Quality	Kutu Pack	500	7.5 Kg	0.195
	126 046 180001	Lüx Buat Kapağı (Bombeli-Plastik Ayak) Lux Junction Box Cover (Curved-Plastic Trivet)	Kutu Pack	500	6 Kg	0.195

PVC İZOLE KAPLI ÇELİK SUSTA

PVC INSULATION COATED STEEL CABLE PULLER

	049 019 300010	PVC İzole Kaplı Çelik Susta 10 mt PVC Insulation Coated Steel Cable Puller 10 m	Kutu Pack	-	-	-
	049 019 300015	PVC İzole Kaplı Çelik Susta 15 mt PVC Insulation Coated Steel Cable Puller 15 m	Kutu Pack	-	-	-
	049 019 300020	PVC İzole Kaplı Çelik Susta 20 mt PVC Insulation Coated Steel Cable Puller 20 m	Kutu Pack	-	-	-
	049 019 300025	PVC İzole Kaplı Çelik Susta 25 mt PVC Insulation Coated Steel Cable Puller 25 m	Kutu Pack	-	-	-

PLASTİK SUSTA (KLAUZ TELLİ)

PLASTIC CABLE PULLER (WITH GUIDE WIRE)

	049 019 400010	Takviyeli Plastik Susta 10 mt Reinforced Plastic Cable Puller, 10 m	Kutu Pack	-	-	-
	049 019 400015	Takviyeli Plastik Susta 15 mt Reinforced Plastic Cable Puller, 15 m	Kutu Pack	-	-	-
	049 019 400020	Takviyeli Plastik Susta 20 mt Reinforced Plastic Cable Puller, 20 m	Kutu Pack	-	-	-
	049 019 400025	Takviyeli Plastik Susta 25 mt Reinforced Plastic Cable Puller, 25 m	Kutu Pack	-	-	-

ÇELİK SUSTA

STEEL CABLE PULLER

	001 019 000010 00 00	1.Kalite 10 mt'lik Susta Premium Quality Cable Puller, 10 m	Kutu Pack	40	27.60 Kg	0.025
	001 019 000015 00 00	1.Kalite 15 mt'lik Susta Premium Quality Cable Puller, 15 m	Kutu Pack	30	31.08 Kg	0.025
	001 019 000020 00 00	1.Kalite 20 mt'lik Susta Premium Quality Cable Puller, 20 m	Kutu Pack	20	27.56 Kg	0.025
	001 019 000025 00 00	1.Kalite 25 mt'lik Susta Premium Quality Cable Puller, 25 m	Kutu Pack	15	25.8 Kg	0.025
	001 019 100010 00 00	1. Kalite 10 mt'lik Tak. Susta Premium Quality Cable Puller, 10 m, Reinforced	Kutu Pack	40	28.64 Kg	0.025
	001 019 100015 00 00	1. Kalite 15 mt'lik Tak. Susta Premium Quality Cable Puller, 15 m, Reinforced	Kutu Pack	30	31.98 Kg	0.025
	001 019 100020 00 00	1. Kalite 20 mt'lik Tak. Susta Premium Quality Cable Puller, 20 m, Reinforced	Kutu Pack	20	28.36 Kg	0.025
	001 019 100025 00 00	1. Kalite 25 mt'lik Tak. Susta Premium Quality Cable Puller, 25 m, Reinforced	Kutu Pack	15	26.55 Kg	0.025
	001 018 000001 00 00	Florasın Zinciri Fluorescent Chain	Kutu Pack	500 m	20.50 Kg	0.017

BETON DUVAR KASALARI CONCRETE WALL CASINGS

	Kod Code	Açıklama Description	Ambalaj Packing	Adet Quantity	Ağırlık Weight	Hacim Volume
	000 700 200037 00 14   	Buat Arka Kapak (Sarı) Junction Box Back Cover (Yellow)	Kutu Pack	500	6 Kg	0.018
	000 700 000037 00 14					
	000 700 200035 00 12   	Buat Gövde 60'lık (Turuncu) Junction Box Body, 60 mm (Orange)	Kutu Pack	350	9.45 Kg	0.130
	000 700 000035 00 12					
	000 700 200256 00 14   	Kalıba Tespit Elemanı (Sarı) Die Fixing Tool (Orange)	Kutu Pack	250	4.09 Kg	0.65
	000 700 000256 00 14					
	000 700 200039 00 12   	Sığ Brüt Anahtar Kasası (Turuncu) Shallow Gross Switch Case (Orange)	Kutu Pack	500	12.53 Kg	0.130
	000 700 000039 00 12					
	000 700 200036 00 14   	Konik Gövde (Sarı) Conical Body (Yellow)	Kutu Pack	250	4.63 Kg.	0.034
	000 700 000036 00 14					
	000 700 200214 00 14   	Aplik 20'lik (Sarı) Bracket Lamp, 20 mm (Yellow)	Kutu Pack	1000	4.34 Kg	0.029
	000 700 000214 00 14					
	000 700 200215 00 12   	Aplik Eğik Bağlantı Dirseği (Turuncu) Bracket Lamp Scarf Joint Bracket (Orange)	Kutu Pack	1000	3.54 Kg	0.039
	000 700 000215 00 12					



PLASTİK KASA VE BUATLAR

PLASTIC CASINGS AND JUNCTION BOXES

	Kod Code	Açıklama Description
--	-------------	-------------------------

TURUNCU BUAT VE KASALAR

ORANGE JUNCTION BOXES AND CASINGS

	 001 046 131102 00 12	Norm Kasa Norm Casing
	001 046 130102 00 12	
	 001 046 131101 00 12	Norm Buat Ø14 Ø18 Çıkışlı Norm Junction Box (with Ø14, Ø18 Outlets)
	001 046 130101 00 12	
	 001 046 161102 00 12	Geçmeli Plastik Kasa Click-Fit Plastic Casing
	001 046 160102 00 12	
	 001 046 161101 00 12	Geçmeli Derin Kasa Click-Fit Deep Casing
	001 046 160101 00 12	
	 001 046 121100 00 12	Geçmeli Alçıpan Kasa Click-Fit Drywall Casing
	001 046 120100 00 12	
	 000 700 100160 00 12	Geçmeli Derin Kasa Gövde Click-Fit Deep Casing Body
	000 700 000160 00 12	
	 000 700 100073 00 12	Geçmeli Derin Kasa Kapak Click-Fit Deep Casing Cover
	000 700 000073 00 12	
 001 046 121101 00 12	Alçıpan Kasa 1'li Drywall Casing, Single	
001 046 120101 00 12		
 001 046 121102 00 12	Alçıpan Kasa 2'li Drywall Casing, Double	
001 046 120102 00 12		
 001 046 121103 00 12	Alçıpan Kasa 3'lü Drywall Casing, Triple	
001 046 120103 00 12		
 001 046 210002 00 12	Tünel Kasa Tunnel Casing	
001 046 170101 00 12		
 001 046 210003 00 12	Tünel Buat Tunnel Junction Box	
001 046 170102 00 12		

SİYAH BUAT VE KASALAR

BLACK JUNCTION BOXES AND CASINGS

	126 046 130103	Norm Kasa Norm Casing
	126 046 130104	Norm Buat Ø14 Ø18 Çıkışlı Norm Junction Box (with Ø14, Ø18 Outlets)
	001 046 160102 00 00	Geçmeli Plastik Kasa Click-Fit Plastic Casing
	126 046 130106	Geçmeli Derin Kasa Click-Fit Deep Casing
	001 046 120100 00 11	Geçmeli Alçıpan Kasa Click-Fit Drywall Casing
	001 046 120101 00 11	Alçıpan Kasa 1'li Drywall Casing, Single
	001 046 120102 00 11	Alçıpan Kasa 2'li Drywall Casing, Double
	001 046 120103 00 11	Alçıpan Kasa 3'lü Drywall Casing, Triple
	001 046 170101 00 11	Tünel Kasa Tunnel Casing
	001 046 170102 00 11	Tünel Buat Tunnel Junction Box

PLASTİK DİRSEKLER

PLASTIC BRACKETS

	127 051 000014	Plastik Ø14 Dirsek Plastic Bracket, Ø14
	127 051 000018	Plastik Ø18 Dirsek Plastic Bracket, Ø18
	127 051 000026	Plastik Ø26 Dirsek Plastic Bracket, Ø26

PLASTİK MUFLAR

PLASTIC PIPE SOCKETS

	001 051 020014 00 11	Plastik Ø14 Muf Plastic Pipe Socket, Ø14
	001 051 020018 00 11	Plastik Ø18 Muf Plastic Pipe Socket, Ø18
	001 051 020026 00 11	Plastik Ø26 Muf Plastic Pipe Socket, Ø26
	001 051 020037 00 11	Plastik Ø37 Muf Plastic Pipe Socket, Ø37
	001 046 000001 00 11	Plastik Takoz (Ø14 Ø18 Çıkışlı) Plastic Cleat (with Ø14, Ø18 Outlets)
	047 109 010013	Anahtar Altı (Desenli) Switch Casings (Patterned)

KROŞELER CABLE STRAPS

	Kod Code	Açıklama Description	Ambalaj Packing	Adet Quantity	Ağırlık Weight	Hacim Volume
--	-------------	-------------------------	--------------------	------------------	-------------------	-----------------

ANTİGRON BORU KROŞELERİ ANTIGRION PIPE STRAPS

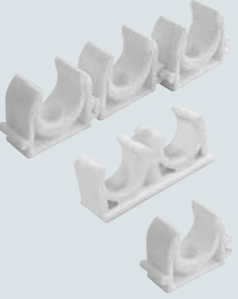
	001 048 010016 00 17	16'lik Antigron Boru Kroşesi Antigron Pipe Straps, Ø16	Kutu Pack	100	0.35 Kg	0.002
	001 048 010018 00 17	18'lik Antigron Boru Kroşesi Antigron Pipe Straps, Ø18	Kutu Pack	100	0.40 Kg	0.003
	001 048 010020 00 17	20'lik Antigron Boru Kroşesi Antigron Pipe Straps, Ø20	Kutu Pack	100	0.42 Kg	0.004
	001 048 010022 00 17	22'lik Antigron Boru Kroşesi Antigron Pipe Straps, Ø22	Kutu Pack	-	-	-
	001 048 010025 00 17	25'lik Antigron Boru Kroşesi Antigron Pipe Straps, Ø25	Kutu Pack	100	0.55 Kg	0.004
	001 048 010027 00 17	27'lik Antigron Boru Kroşesi Antigron Pipe Straps, Ø27	Kutu Pack	-	-	-
	001 048 010032 00 17	32'lik Antigron Boru Kroşesi Antigron Pipe Straps, Ø32	Kutu Pack	50	0.33 Kg	0.004
	001 048 010040 00 17	40'lik Antigron Boru Kroşesi Antigron Pipe Straps, Ø40	Kutu Pack	100	1.60 Kg	0.026

DÜBELLİ KROŞELER CABLE STRAPS WITH DOWEL

	001 048 090002 00 17	3/13 Tekli Kablo Kroşesi 3/13 Single Cable Strap	Kutu Pack	500	0.250 Kg	-
	001 048 090006 00 17	8/28 Tekli Kablo Kroşesi 8/28 Single Cable Strap	Kutu Pack	500	0.500 Kg	-
	001 048 090003 00 17	16'lik Dübelli Boru Kroşesi Tekli Pipe Crochet with Ø16 Dowel, Single	Kutu Pack	5000	9.85 Kg	0.516
	001 048 090004 00 17	20'lik Dübelli Boru Kroşesi Tekli Pipe Crochet with Ø20 Dowel, Single	Kutu Pack	5000	13.56 Kg	0.755
	001 048 090005 00 17	25'lik Dübelli Boru Kroşesi Tekli Pipe Crochet with Ø25 Dowel, Single	Kutu Pack	3000	13.42 Kg	0.753

MUTLUSAN BETON ÇİVİLİ KROŞELER MUTLUSAN CABLE STRAPS WITH CONCRETE NAIL

	032 048 070000	No.0 Beton Çivili Kroşe 0.75 Yassı Kord. Kroşe No. 0 Cable Strap with Concrete Nail 0.75 Flat Cord Cable Strap	Kutu Pack	30000	17.7 Kg	0.028
	032 048 070001	No.1 Beton Çivili Kroşe 0.75 Yassı Kord. Kroşe No. 1 Cable Strap with Concrete Nail 0.75 Flat Cord Cable Strap	Kutu Pack	30000	15.86 Kg	0.028
	032 048 070002	No.2 Beton Çivili Kroşe 0.75 Yassı Kord. Kroşe No. 2 Cable Strap with Concrete Nail 0.75 Flat Cord Cable Strap	Kutu Pack	20000	19.40 Kg	0.028
	032 048 070003	No.3 Beton Çivili Kroşe (2x1.5-3x1.5) No. 3 Cable Strap with Concrete Nail (2x1.5 - 3x1.5)	Kutu Pack	20000	24.62 Kg	0.060
	032 048 070004	No.4 Beton Çivili Kroşe (2x4) No.4 Cable Strap with Concrete Nail (2x4)	Kutu Pack	20000	26.44 Kg	0.060
	032 048 070005	No.5 Beton Çivili Kroşe (2x4-4x4) No. 5 Cable Strap with Concrete Nail (2x4-4x4)	Kutu Pack	10000	19 Kg	0.053
	032 048 070006	No.6 Beton Çivili Kroşe (2x6) No. 6 Cable Strap with Concrete Nail (2x6)	Kutu Pack	10000	23.87 Kg	0.055
	032 048 070007	No.7 Beton Çivili Kroşe (4x10) No. 7 Cable Strap with Concrete Nail (4x10)	Kutu Pack	8000	20.66 Kg	0.045
	032 048 070008	No.8 Beton Çivili Kroşe (3x16+10) No. 8 Cable Strap with Concrete Nail (3x26+10)	Kutu Pack	5000	25.70 Kg	0.070
	032 048 070009	No.9 Beton Çivili Kroşe (3x25+16) No. 9 Cable Strap with Concrete Nail (3x25+16)	Kutu Pack	5000	31 Kg	0.090

KROŞELER CABLE STRAPS

	Kod Code	Açıklama Description	Ambalaj Packing	Adet Quantity	Ağırlık Weight	Hacim Volume
--	-------------	-------------------------	--------------------	------------------	-------------------	-----------------

TANDIR KROŞELER METALLIC CABLE STRAPS

	035 048 110001	No.1 Tandir Kroşe (2x1.5-2x6) No. 1 Metallic Cable Straps	Kutu Pack	350	3.87 Kg	0.0027
	035 048 110002	No.2 Tandir Kroşe (4x6) No. 2 Metallic Cable Straps	Kutu Pack	250	2.17 Kg	0.0027
	035 048 110003	No.3 Tandir Kroşe (4x10) No. 3 Metallic Cable Straps	Kutu Pack	-	2.65 Kg	0.0027
	035 048 110004	No.4 Tandir Kroşe (4x16) No. 4 Metallic Cable Straps	Kutu Pack	150	2.11 Kg	0.0027
	035 048 110005	No.5 Tandir Kroşe (3x25+16) No. 5 Metallic Cable Straps	Kutu Pack	150	2.21 Kg	0.0027

RAY KROŞELER RAIL CABLE STRAPS

	035 048 100001	No.1 Ray Kroşe (2x1.5-4x2.5) No. 1 Rail Cable Straps	Kutu Pack	350	2.34 Kg	0.0057
	035 048 100002	No.2 Ray Kroşe (4x4-4x16) No. 2 Rail Cable Straps	Kutu Pack	250	2.14 Kg	0.0057
	001 025 010100 00 00	Galvaniz Ray Kroşe Galvanized Rail Cable Straps	Kutu Pack	50	12.5 Kg	0.013

ANTİGRON KROŞELER ANTIGRION CABLE STRAPS

	128 048 000001	No.1 (2x1.5-2x2.5-3x1.5-3x2.5)	Kutu Pack	2000	10.58 Kg	0.081
	128 048 000015	No.1.5 (2x4-2x6-4x4-4x6)	Kutu Pack	1500	9.33 Kg	0.061
	128 048 000002	No.2 (4x10)	Kutu Pack	1250	11.11 Kg	0.051
	128 048 000003	No.3 (4x16-3x25+16)	Kutu Pack	750	-	-

GALVANİZ SAC KROŞELER GALVANIZED SHEET CABLE STRAPS

	001 048 060001 00 00	No.1 Tekli No. 1 Single	Ø 10 mm	Kutu Pack	1500	6.6 Kg	0.006
	001 048 060002 00 00	No.2 Tekli No. 2 Single	Ø 14 mm	Kutu Pack	1000	6 Kg	0.006
	001 048 060003 00 00	No.3 Tekli No. 3 Single	Ø 16 mm	Kutu Pack	700	5.11 Kg	0.006
	001 048 060004 00 00	No.4 Tekli No. 4 Single	Ø 20 mm	Kutu Pack	500	4.25 Kg	0.006
	001 048 060007 00 00	No.7 Tekli No. 7 Single	Ø 25 mm	Kutu Pack	350	3.82 Kg	0.006
	001 048 060008 00 00	No.8 Tekli No. 8 Single	Ø 40 mm	Kutu Pack	250	3.28 Kg	0.006
	001 048 060009 00 00	No.9 Tekli No. 9 Single	Ø 45.5 mm	Kutu Pack	200	2.98 Kg	0.006
	001 048 060010 00 00	No.10 Tekli No. 10 Single	Ø 50.5 mm	Kutu Pack	150	2.31 Kg	0.006
	001 048 070002 00 00	No.2 Çiftli No. 2 Double	Ø 13 mm	Kutu Pack	600	4.75 Kg	0.006
	001 048 070003 00 00	No.3 Çiftli No. 3 Double	Ø 15.5 mm	Kutu Pack	500	4.18 Kg	0.006
	001 048 070004 00 00	No.4 Çiftli No. 4 Double	Ø 22 mm	Kutu Pack	400	3.70 Kg	0.006
001 048 070007 00 00	No.7 Çiftli No. 7 Double	Ø 26 mm	Kutu Pack	400	4.92 Kg	0.008	
001 048 070008 00 00	No.8 Çiftli No. 8 Double	Ø 33 mm	Kutu Pack	300	4.09 Kg	0.008	
001 048 070009 00 00	No.9 Çiftli No. 9 Double	Ø 44 mm	Kutu Pack	200	3.43 Kg	0.008	
001 048 070010 00 00	No.10 Çiftli No. 10 Double	Ø 48 mm	Kutu Pack	150	2.84 Kg	0.008	
001 048 070011 00 00	No.11 Çiftli No. 11 Double	Ø 55.5 mm	Kutu Pack	100	2.08 Kg	0.008	

PLASTİK DÜBELLER

PLASTIC DOWELS

	Kod Code	Açıklama Description	Ambalaj Packing	Adet Quantity	Ağırlık Weight	Hacim Volume
	016 053 000014	Burgulu Alçıpan Dübeli Twisted Drywall Dowel	Kutu Pack	-	-	-
	016 053 308100	8x100mm Boşluk Dübeli 8x100mm Spacer Dowel	Kutu Pack	5000	15 Kg	0.07
	016 053 100002	Mega Dübel Mega Dowel	Kutu Pack	500	0.78 Kg	-
	001 053 000001 00 00	Alçıpan Dübeli Drywall Dowel	Kutu Pack	250	0.33 Kg	0.003
	001 053 000002 00 00	Kanal Dübeli Trunking Dowel	Kutu Pack	500	0.60 Kg	0.003
	001 053 000003 00 00	Dübelli Kablo Bağı Vidası Cable Tie Screw with Dowel	Kutu Pack	100	0.12 Kg	0.002
	001 053 000013 00 00	Dübelli Kablo Bağı 20 cm Cable Tie with Dowel, 20 cm	Kutu Pack	-	-	-
	001 053 000004 00 00	Dübelli Kablo Bağı 15 cm Cable Tie with Dowel, 15 cm	Kutu Pack	-	-	-
	001 053 000005 00 00	Korniş Dübeli Curtain Rod Dowel	Kutu Pack	500	0.60 Kg	0.003
	016 053 000006	6 mm Beyaz Dübél 6 mm Dowel, White	Kutu Pack	1	0.0004 Kg	0.000002
	016 053 000007	7 mm Beyaz Dübél 7 mm Dowel, White	Kutu Pack	25000	15 Kg	0.05
	016 053 000008	8 mm Beyaz Dübél 8 mm Dowel, White	Kutu Pack	20000	18 Kg	0.06
	016 053 000010	10 mm Beyaz Dübél 10 mm Dowel, White	Kutu Pack	10000	18 Kg	0.07
	016 053 000012	12 mm Beyaz Dübél 12 mm Dowel, White	Kutu Pack	250	0.3 Kg	0.0025
	016 053 000106	6 mm Renkli Dübél (Yeşil) 6 mm Colored Dowel (Green)	Kutu Pack	1000	1.2 Kg	0.002
	016 053 000107	7 mm Renkli Dübél (Sarı) 7 mm Colored Dowel (Yellow)	Kutu Pack	1000	1.2 Kg	0.002
	016 053 000108	8 mm Renkli Dübél (Kırmızı) 8 mm Colored Dowel (Red)	Kutu Pack	1000	1.2 Kg	0.002
	016 053 000110	10 mm Renkli Dübél (Mavi) 10 mm Colored Dowel (Blue)	Kutu Pack	500	0.6 Kg	0.0025
	016 053 300008	8 mm Roket Dübél 8 mm Rocket Dowel	Kutu Pack	1000	1.2 Kg	0.002
	016 053 300010	10 mm Roket Dübél 10 mm Rocket Dowel	Kutu Pack	5000	6 Kg	-

AYDINLATMA

LIGHTING FIXTURES

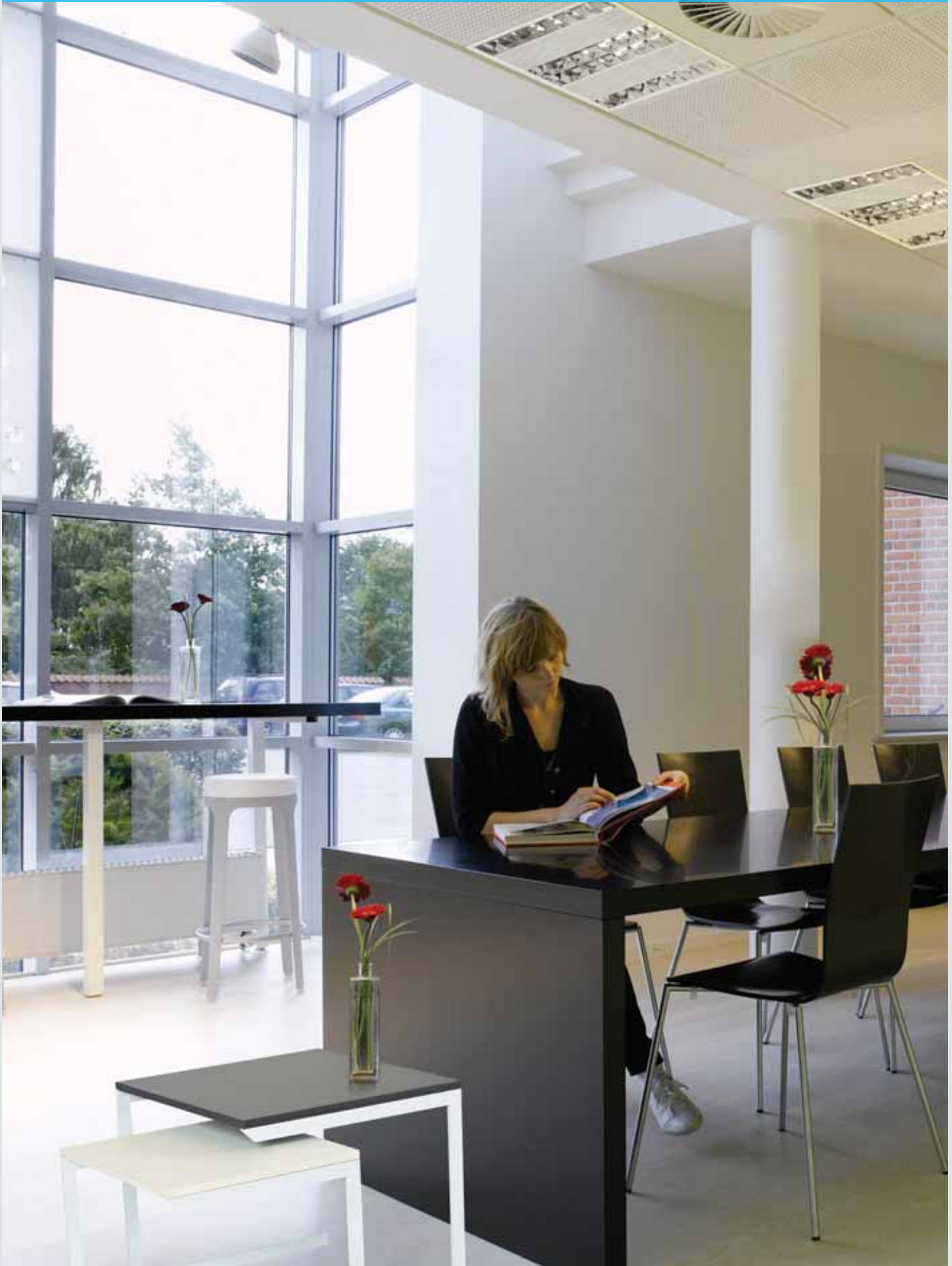



OSRAM LED ve PHILIPS DRIVER kullanılmıştır.
We use OSRAM LED ve PHILIPS DRIVER

SLIMLED

LED Panel Aydınlatma
LED PANEL Lighting

Ürün Kodu / Product Code

006 087 60 XXXX 60x60 Sıvaltı Panel - Recessed Mounted Panel

- | | | |
|---|-----------------|------------------------------------------------------|
| 1 | 999 999 999 322 | 60x60 Clip-in Aparat - 60x60 Clip-in Apparatus |
| 2 | 999 999 999 320 | 60x60 Alçıpan Tavan Aparat - 60x60 Drywall Apparatus |
| 3 | 999 999 999 321 | 60x60 Sıvaüstü Aparat - 60x60 S/M Apparatus |

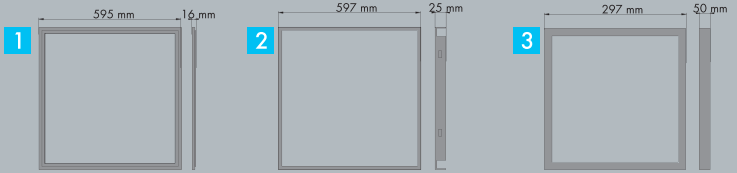

CONCORDELED

LED Etanj Armatür
LED Waterproof Luminaires

Ürün Kodu / Product Code

016 039 106020

Ölçü - Dimensions 60 cm

Güç - Power 20W

Lumen 2640 Lm

Işık Renk - Light Color 6500K

IP 66

Ürün Kodu / Product Code

016 039 112028

Ölçü - Dimensions 120 cm

Güç - Power 28 W

Lumen 3520 Lm

Işık Renk - Light Color 6500K

IP 66



LEDETANJ

LED Etanj Armatür
LED Waterproof Luminaires

Ürün Kodu / Product Code	016 039 006010	016 039 006020	016 039 012020	016 039 012040
Ölçü - Dimensions	60 cm	60 cm	120 cm	120 cm
Güç - Power	10 W	20 W	20 W	40 W
Lumen	1300Lm	2400Lm	2600Lm	4800Lm
Işık Renk - Light Color	6500K	6500K	6500K	6500K

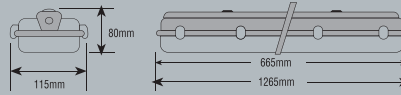

WALWASHER

LED Aydınlatma Armatür
LED Lighting Luminaires

Ürün Kodu / Product Code	016 040 100001	016 040 100002	016 040 100003	016 040 100004	016 040 100005	016 040 100006
Led Sayısı - Led Pcs	12	12	18	18	36	36
Ölçü - Dimensions	35 cm	35 cm	50 cm	50 cm	100 cm	100 cm
Güç - Power	12 W	12 W	18 W	18 W	32 W	32 W
Lumen	900Lm	963Lm	1550Lm	1605Lm	3000Lm	3210Lm
Işık Renk - Light Color	3000K	6500K	3000K	6500K	3000K	6500K

T8**Sıvaüstü Çift Parabolik Armatürler (Elektronik Balastlı)**
S/M Double Parabolic Lighting Luminaries (Electronic Ballast)

Ürün Kodu / Product Code

090 038 000218 TIL-218-SM S/Ü 2x18

090 038 000418 TIL-418-SM S/Ü 4x18

090 038 000236 TIL-236-SM S/Ü 2x36

Özellikler

Gövde : 0.5mm DKP- Galvanizli sac
 Boya : Beyaz elektrostatik toz boya
 Güç : 230 V 50Hz
 Reflektör : Yüksek kaliteli %99.99 saflıkta alüminyum parlak ve mat reflektor seçeneği.
 Balast : Elektronik (Philips, Tridonic), Dim edilebilir ballast seçeneği
 Opsiyon : Acil durum kiti

Description

Body : 0.5mm DKP - Galvanized steel
 Paint : Electrostatic white powder paint
 Power : 230 V 50 Hz
 Reflector : High quality %99.99 pure aluminium specular or matt option.
 Ballast : Electronic (Philips, Tridonic), Dimmable ballast option
 Optional : Emergency kit

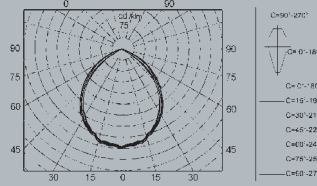
**T8****Sıvaaltı Çift Parabolik Armatürler (Elektronik Balastlı)**
R/M Double Parabolic Lighting Luminaries (Electronic Ballast)

Ürün Kodu / Product Code

090 038 100218 TIL-218-RM S/A 2x18

090 038 100418 TIL-418-RM S/A 4x18

090 038 100236 TIL-236-RM S/A 2x36

Özellikler

Gövde : 0.5mm DKP- Galvanizli sac
 Boya : Beyaz elektrostatik toz boya
 Güç : 230 V 50Hz
 Reflektör : Yüksek kaliteli %99.99 saflıkta alüminyum parlak ve mat reflektor seçeneği.
 Balast : Elektronik (Philips, Tridonic), Dim edilebilir ballast seçeneği
 Opsiyon : Acil durum kiti

Description

Body : 0.5mm DKP - Galvanized steel
 Paint : Electrostatic white powder paint
 Power : 230 V 50 Hz
 Reflector : High quality %99.99 pure aluminium specular or matt option.
 Ballast : Electronic (Philips, Tridonic), Dimmable ballast option
 Optional : Emergency kit

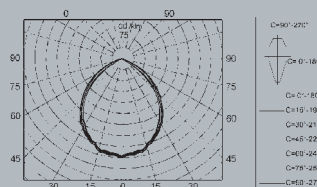

**T8**

Sıvaüstü Çift Parabolik Armatürler (Mekanik Balastlı) S/M Double Parabolic Lighting Luminaries (Mekanik Ballast)

Ürün Kodu / Product Code

090 039 171218 218-SM S/Ü 2x18

090 039 151418 418-SM S/Ü 4x18

090 039 171236 236-SM S/Ü 2x36

Özellikler

Gövde : 0.5mm DKP- Galvanizli sac
Boya : Beyaz elektrostatik toz boya
Güç : 230 V 50Hz
Reflektör : Yüksek kaliteli %99.99 saflıkta alüminyum parlak ve mat reflektör seçeneği.
Balast : Elektronik (Philips, Tridonic), Dim edilebilir ballast seçeneği
Opsiyon : Acil durum kiti

Description

Body : 0.5mm DKP - Galvanized steel
Paint : Electrostatic white powder paint
Power : 230 V 50 Hz
Reflector : High quality %99.99 pure aluminium specular or matt option.
Ballast : Electronic (Philips, Tridonic), Dimmable ballast option
Optional : Emergency kit

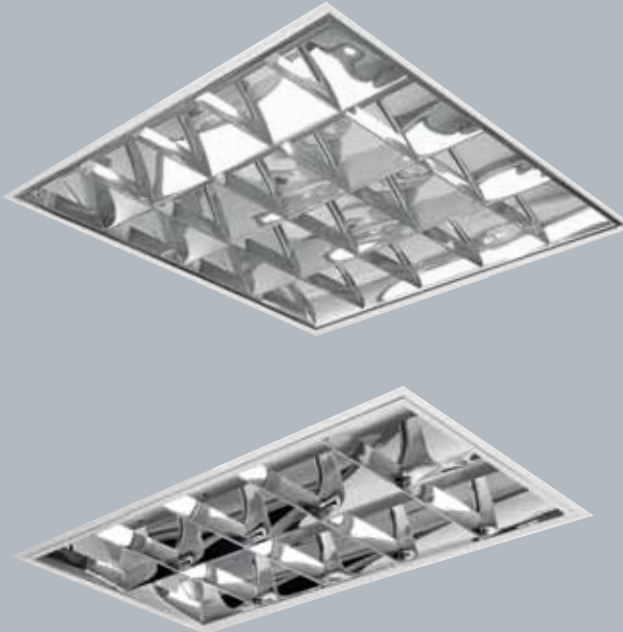
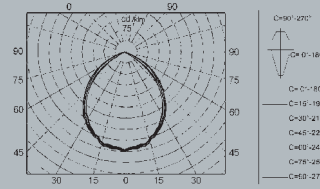
**T8**

Sıvaaltı Çift Parabolik Armatürler (Mekanik Balastlı) R/M Double Parabolic Lighting Luminaries (Mekanik Ballast)

Ürün Kodu / Product Code

090 038 100218 TIL-218-RM S/A 2x18

090 038 100418 TIL-418-RM S/A 4x18

090 038 100236 TIL-236-RM S/A 2x36

Özellikler

Gövde : 0.5mm DKP- Galvanizli sac
Boya : Beyaz elektrostatik toz boya
Güç : 230 V 50Hz
Reflektör : Yüksek kaliteli %99.99 saflıkta alüminyum parlak ve mat reflektör seçeneği.
Balast : Elektronik (Philips, Tridonic), Dim edilebilir ballast seçeneği
Opsiyon : Acil durum kiti

Description

Body : 0.5mm DKP - Galvanized steel
Paint : Electrostatic white powder paint
Power : 230 V 50 Hz
Reflector : High quality %99.99 pure aluminium specular or matt option.
Ballast : Electronic (Philips, Tridonic), Dimmable ballast option
Optional : Emergency kit

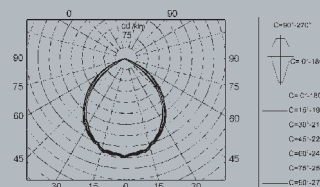

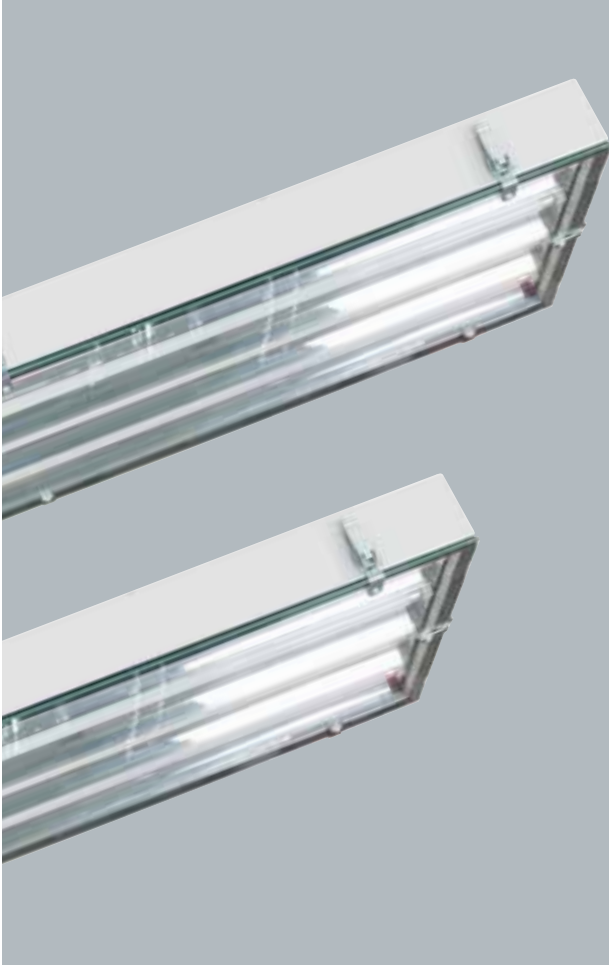

TL5 Yüksek Tavan Aydınlatma Armatürleri High Ceiling Lighting Luminaire

Ürün Kodu / Product Code

090 039 400228	2x28W TL5
090 039 400428	4x28W TL5
090 039 400254	2x54W TL5
090 039 400454	4x54W TL5
090 039 400235	2x35W TL5
090 039 400435	4x35W TL5
090 039 400280	2x80W TL5
090 039 400480	4x80W TL5

Özellikler

Gövde : 0.5 mm DKP sac,
Boya : Gri elektrostatik toz boya
Güç : 230 V 50 Hz
Balast : Elektronik (EVG), Dim edilebilir balast seçeneği (EVG DIMM)
Opsiyon : Acil durum kit

Description

Body : 0.5 mm DKP sheet
Paint : Electrostatic white powder paint
Power : 230V 50 Hz
Ballast : Electronic (EVG), Dimmable ballast option (EVG DIMM)
Optional : Emergency kit

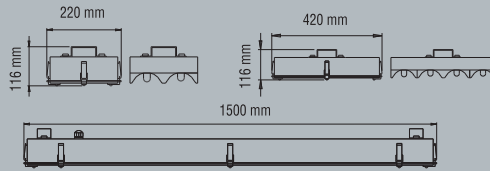

TMS Bant Tipi T8 Mekanik Armatürler Batten Type T8 Mekanik Luminaries

Ürün Kodu / Product Code

078 038 900118	1x18W
078 038 900136	1x36W
078 038 900218	2x18W
078 038 900236	2x36W

Özellikler

Gövde : 0.5 mm DKP sac,
Boya : Beyaz elektrostatik toz boya
Güç : 230 V 50 Hz

Description

Body : 0.5 mm DKP sheet
Paint : Electrostatic white powder paint
Power : 230V 50 Hz

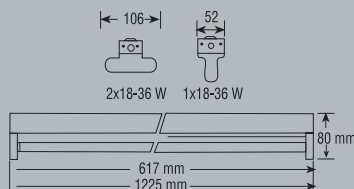

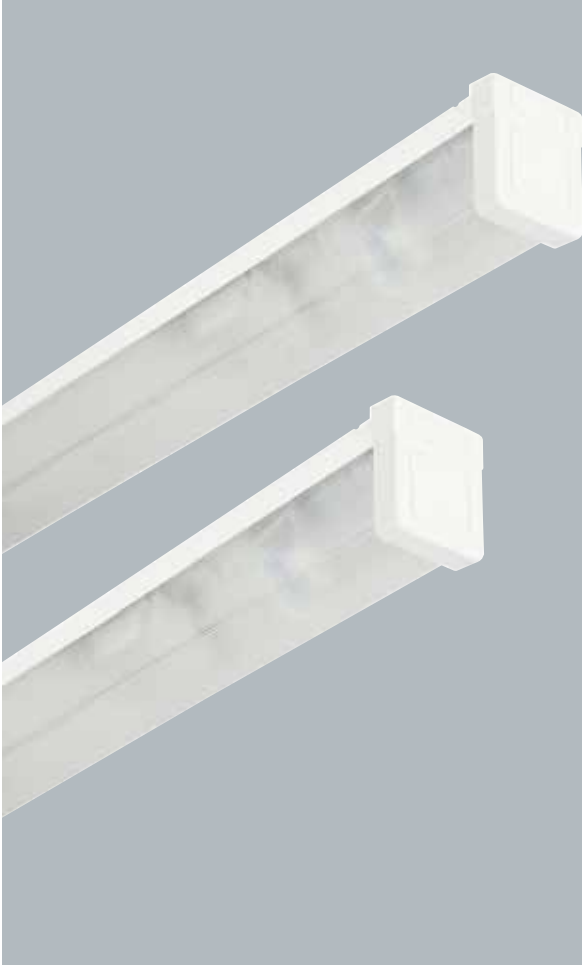
**TSC**Okul Tipi Armatürler (Elektronik Tridonic Balastlı)
School Type (Electronic Tridonic Ballast)

Ürün Kodu / Product Code

078 040 050118 1x18W

078 040 050136 1x36W

078 040 050218 2x18W

078 040 050236 2x36W

Özellikler

Gövde : 0.5 mm DKP sac,
Boya : Beyaz elektrostatik
toz boya
Güç : 230 V 50 Hz
Kapak : PMMA

Description

Body : 0.5 mm DKP sheet
Paint : Electrostatic white
powder paint
Power : 230V 50 Hz
Diffuzor : PMMA

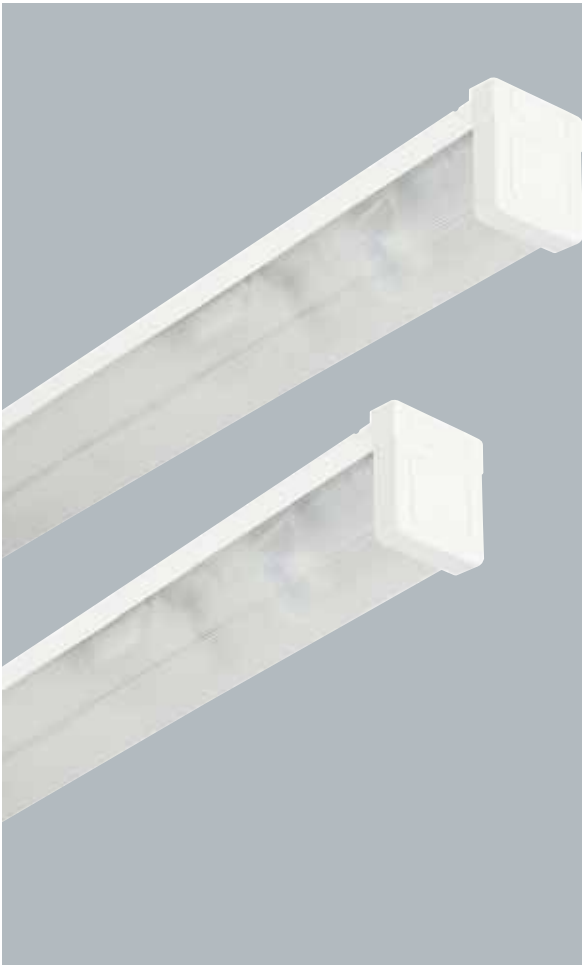
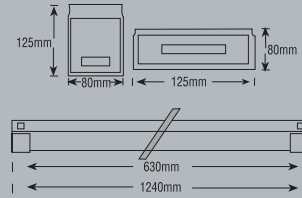
**TSC**Okul Tipi Armatürler (Mekanik Balastlı)
School Type (Mekanik Ballast)

Ürün Kodu / Product Code

078 038 050118 1x18W

078 038 050136 1x36W

078 038 050218 2x18W

078 038 050236 2x36W

Özellikler

Gövde : 0.5 mm DKP sac,
Boya : Beyaz elektrostatik
toz boya
Güç : 230 V 50 Hz
Kapak : PMMA

Description

Body : 0.5 mm DKP sheet
Paint : Electrostatic white
powder paint
Power : 230V 50 Hz
Diffuzor : PMMA

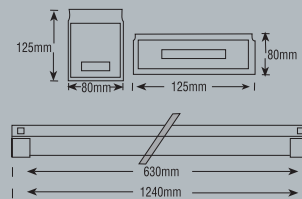

**U TİPİ**

Etanj Aydınlatma Armatürleri PC Cam
(Elektronik Tridonic Balastlı)

Waterproof Luminaires PC Glass
(Electronic Tridonic Ballast)

Ürün Kodu / Product Code

- 090 038 220118 1x18 PC Cam PC Gövde - 1x18 PC Glass PC Body
 090 038 220218 2x18 PC Cam PC Gövde - 2x18 PC Glass PC Body
 090 038 220136 1x36 PC Cam PC Gövde - 1x36 PC Glass PC Body
 090 038 220236 2x36 PC Cam PC Gövde - 2x36 PC Glass PC Body

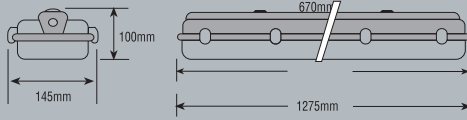
**U TİPİ**

Etanj Aydınlatma Armatürleri PC Cam
(Mekanik Balastlı)

Waterproof Luminaires PC Glass
(Mekanik Ballast)

Ürün Kodu / Product Code

- 090 038 210118 1x18 PC Cam PC Gövde - 1x18 PC Glass PC Body
 090 038 210218 2x18 PC Cam PC Gövde - 2x18 PC Glass PC Body
 090 038 210136 1x36 PC Cam PC Gövde - 1x36 PC Glass PC Body
 090 038 210236 2x36 PC Cam PC Gövde - 2x36 PC Glass PC Body

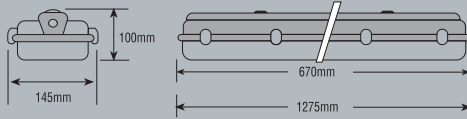
**U TİPİ**

Etanj Aydınlatma Armatürleri Akrilik Cam
(Mekanik Balastlı)

Waterproof Luminaires Acrylic Glass
(Mekanik Ballast)

Ürün Kodu / Product Code

- 066 038 910118 1x18 Akrilik Cam PC Gövde - 1x18 Acrylic Glass PC Body
 066 038 910218 2x18 Akrilik Cam PC Gövde - 2x18 Acrylic Glass PC Body
 066 038 910136 1x36 Akrilik Cam PC Gövde - 1x36 Acrylic Glass PC Body
 066 038 910236 2x36 Akrilik Cam PC Gövde - 2x36 Acrylic Glass PC Body

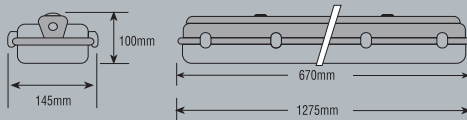

**MINI**Tavan Glob Armatür
Ceiling Globe Lighting FixtureÜrün Kodu / Product Code
016 038 250031

E27 MAX. 1x75W - 230 V ~ 50 Hz IP20

Ambalaj Şekli / Package Type Kutu / Pack

Adet / m / Quantity / m 48

Ağırlık / Weight 15.77 kg

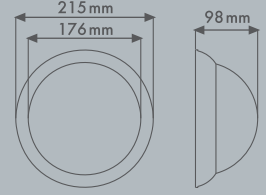
m³ / Volume 0.210**BÜYÜK**Tavan Glob Armatür (Büyük)
Ceiling Globe Lighting Fixture (Mega)Ürün Kodu / Product Code
016 038 250036

E27 MAX. 1x75W - 230 V ~ 50 Hz IP20

Ambalaj Şekli / Package Type Kutu / Pack

Adet / m / Quantity / m 36

Ağırlık / Weight 14 kg

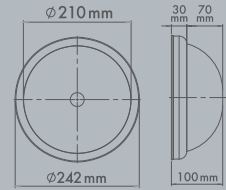
m³ / Volume 0.231**MEGA**Tavan Glob Armatür (Büyük Mega)
Ceiling Globe Lighting Fixture (Mega huge)Ürün Kodu / Product Code
016 038 250043

E27 MAX. 1x75W - 230 V ~ 50 Hz IP20

Ambalaj Şekli / Package Type Kutu / Pack

Adet / m / Quantity / m 36

Ağırlık / Weight 15.83 kg

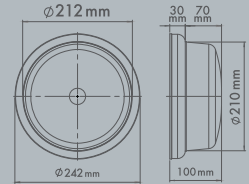
m³ / Volume 0.243**YASEMİN**Ufo Küre Tavan Armatürü
Ufo Globe Ceiling Lighting FixtureÜrün Kodu / Product Code
001 038 050101 00 00





E27 MAX. 1x60W - 230 V ~ 50 Hz

Ambalaj Şekli / Package Type Kutu / Pack

Adet / m / Quantity / m 12

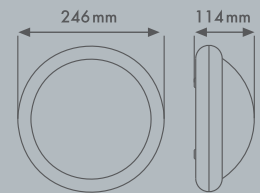
Ağırlık / Weight 4.08 kg

m³ / Volume 0.082

**YASEMİN**Ufo Düz Tavan Armatürü
Ufo Flat Ceiling Lighting FixtureÜrün Kodu / Product Code
001 038 070101 00 00

CLASS II IP20

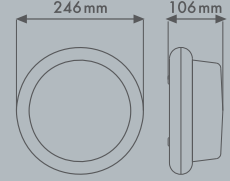

E27 MAX. 1x60W - 230 V ~ 50 Hz

Ambalaj Şekli / Package Type	Kutu / Pack	Ağırlık / Weight	4.53 kg
Adet / m / Quantity / m	12	m ³ / Volume	0.082

**YASEMİN**Küre Tavan Armatürü
Globe Ceiling Lighting FixtureÜrün Kodu / Product Code
001 038 060101 00 00

CLASS I IP20

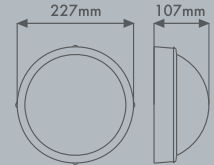

E27 MAX. 1x60W - 230 V ~ 50 Hz

Ambalaj Şekli / Package Type	Kutu / Pack	Ağırlık / Weight	5.59 kg
Adet / m / Quantity / m	12	m ³ / Volume	0.082

**YASEMİN**Düz Tavan Armatürü
Flat Ceiling Lighting FixtureÜrün Kodu / Product Code
001 038 030101 00 00

CLASS I IP20

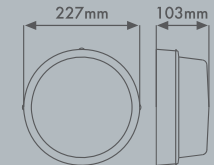

E27 MAX. 1x60W - 230 V ~ 50 Hz

Ambalaj Şekli / Package Type	Kutu / Pack	Ağırlık / Weight	3.52 kg
Adet / m / Quantity / m	12	m ³ / Volume	0.082

**YASEMİN**Ufo Tavan Armatürü
Ufo Ceiling Lighting FixtureÜrün Kodu / Product Code
001 038 040101 00 00

CLASS II IP20

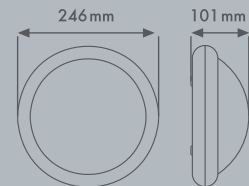

E27 MAX. 1x60W - 230 V ~ 50 Hz

Ambalaj Şekli / Package Type	Kutu / Pack	Ağırlık / Weight	4.11 kg
Adet / m / Quantity / m	12	m ³ / Volume	0.082



ORKİDE

Tavan Armatürü
Ceiling Lighting Fixture

Ürün Kodu / Product Code
001 038 120101 00 00



E27 MAX. 1x60W - 230 V ~ 50 Hz

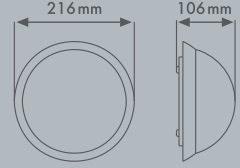

Ambalaj Şekli / Package Type	Kutu / Pack	Ağırlık / Weight	5.66 kg
Adet / m / Quantity / m	24	m ³ / Volume	0.097



YONCA

Tavan Armatürü
Lighting Fixture

Ürün Kodu / Product Code
001 038 160101 00 00



CLASS I IP20



E27 MAX. 1x60W - 230 V ~ 50 Hz

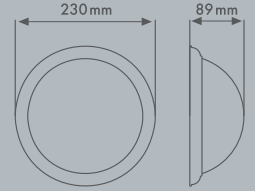

Ambalaj Şekli / Package Type	Kutu / Pack	Ağırlık / Weight	4.01 kg
Adet / m / Quantity / m	16	m ³ / Volume	0.064



KARE

Tavan Glob Armatür
Square Ceiling Globe Lighting Fixture

Ürün Kodu / Product Code
016 038 250014

E27 MAX. 1x75W - 230 V ~ 50 Hz IP20

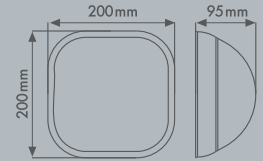

Ambalaj Şekli / Package Type	Kutu / Pack
Adet / m / Quantity / m	48
Ağırlık / Weight	16.30 kg
m ³ / Volume	0.210



MİDİ

Tavan Glob Armatür
Ceiling Globe Lighting Fixture

Ürün Kodu / Product Code
016 038 250032

E27 MAX. 1x75W - 230 V ~ 50 Hz IP20

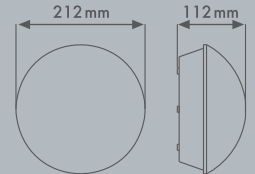

Ambalaj Şekli / Package Type	Kutu / Pack
Adet / m / Quantity / m	36
Ağırlık / Weight	16.50 kg
m ³ / Volume	0.229

**MAXI****Tavan Glob Armatür**
Ceiling Globe Lighting FixtureÜrün Kodu / Product Code
016 038 250033

E27 MAX. 1x75W - 230 V ~ 50 Hz IP20

Ambalaj Şekli / Package Type Kutu / Pack

Adet / m / Quantity / m 36

Ağırlık / Weight 16 kg

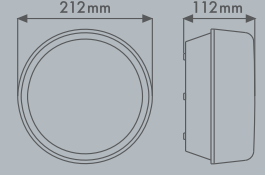
m³ / Volume 0.229**KARE****Tavan Glob Armatür (Kafesli)**
Square Ceiling Globe Lighting Fixture (Protected)Ürün Kodu / Product Code
016 038 250015

E27 MAX. 1x75W - 230 V ~ 50 Hz IP20

Ambalaj Şekli / Package Type Kutu / Pack

Adet / m / Quantity / m 48

Ağırlık / Weight 17.5 kg

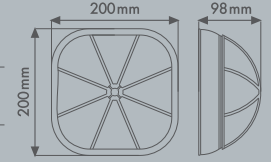
m³ / Volume 0.210**MAXI****Tavan Glob Armatür (Kafesli)**
Protected Ceiling Globe Lighting FixtureÜrün Kodu / Product Code
016 038 250034

E27 MAX. 1x75W - 230 V ~ 50 Hz IP20

Ambalaj Şekli / Package Type Kutu / Pack

Adet / m / Quantity / m 36

Ağırlık / Weight 17.40 kg

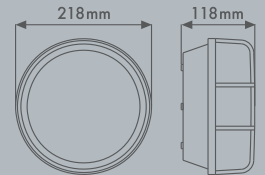
m³ / Volume 0.229

**OVAL**

Düz Armatür
Antigrön Lighting Fixture

Ürün Kodu / Product Code
016 038 250028

E27 MAX. 1x60W - 230 V ~ 50 Hz IP20

Ambalaj Şekli / Package Type Kutu / Pack

Adet / m / Quantity / m 48

Ağırlık / Weight 15.77 kg

m³ / Volume 0.138

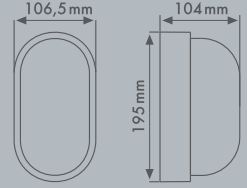
**OVAL**

Kafesli Armatür
Oval Antigrön Lighting Fixture

Ürün Kodu / Product Code
016 038 250029

E27 MAX. 1x60W - 230 V ~ 50 Hz IP20

Ambalaj Şekli / Package Type Kutu / Pack

Adet / m / Quantity / m 48

Ağırlık / Weight 16.47 kg

m³ / Volume 0.138

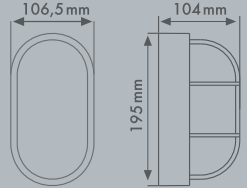
**OVAL**

Şapkalı Armatür
Antigrön Lighting Fixture With Hat

Ürün Kodu / Product Code
016 038 250030

E27 MAX. 1x60W - 230 V ~ 50 Hz IP20

Ambalaj Şekli / Package Type Kutu / Pack

Adet / m / Quantity / m 48

Ağırlık / Weight 17.80 kg

m³ / Volume 0.138

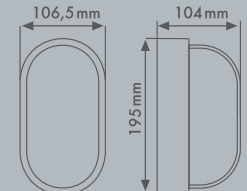
**OVALLED**

Kafesli Led Armatür
Oval Antigrön Led Lighting Fixture

Ürün Kodu / Product Code
016 038 270001

IP 20

Ambalaj Şekli / Package Type Kutu / Pack

Adet / m / Quantity / m 20

Ağırlık / Weight 6.86 kg

m³ / Volume 0.058

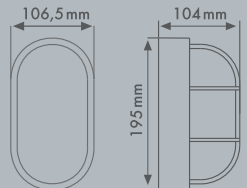



OVAL SİYAH

Kafesli Armatür Siyah
Antigrön Lighting Fixture Black

Ürün Kodu / Product Code
016 038 250049

E27 MAX. 1x60W - 230 V ~ 50 Hz IP20

Ambalaj Şekli / Package Type Kutu / Pack

Adet / m / Quantity / m 48

Ağırlık / Weight 16.47 kg

m³ / Volume 0.138

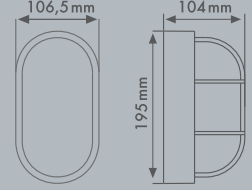

OVAL

Nemliyer Waterproff
Antigrön Lighting Fixture

Ürün Kodu / Product Code
016 038 250039

E27 MAX. 1x60W - 230 V ~ 50 Hz IP 44

Ambalaj Şekli / Package Type Kutu / Pack

Adet / m / Quantity / m 48

Ağırlık / Weight 15.77 kg

m³ / Volume 0.138

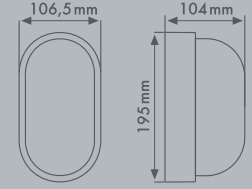

OVAL

Nemliyer Waterproff
Antigrön Lighting Fixture

Ürün Kodu / Product Code
016 038 250040

E27 MAX. 1x60W - 230 V ~ 50 Hz IP 44

Ambalaj Şekli / Package Type Kutu / Pack

Adet / m / Quantity / m 48

Ağırlık / Weight 16.47 kg

m³ / Volume 0.138

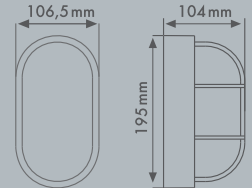

OVAL

Nemliyer Waterproff
Antigrön Lighting Fixture With Hat

Ürün Kodu / Product Code
016 038 250041

E27 MAX. 1x60W - 230 V ~ 50 Hz IP 44

Ambalaj Şekli / Package Type Kutu / Pack

Adet / m / Quantity / m 48

Ağırlık / Weight 17.80 kg

m³ / Volume 0.138

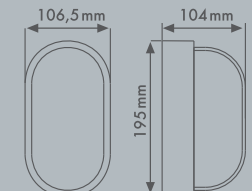



BEGONYA

Nemliyer Waterproff

Tavan ve Duvar Armatürü (Dikey)
Ceiling & Wall Lighting Fixture (Vertical)

Ürün Kodu / Product Code
001 038 130101 00 00



CLASS II IP54



E27 MAX. 1x60W - 230 V ~ 50 Hz

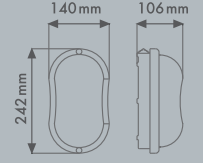

Ambalaj Şekli / Package Type	Kutu / Pack	Ağırlık / Weight	4.68 kg
Adet / m / Quantity / m	12	m ³ / Volume	0.043



BEGONYA

Nemliyer Waterproff

Tavan ve Duvar Armatürü (Yatay)
Ceiling & Wall Lighting Fixture (Horizontal)

Ürün Kodu / Product Code
001 038 140101 00 00



CLASS II IP54



E27 MAX. 1x60W - 230 V ~ 50 Hz

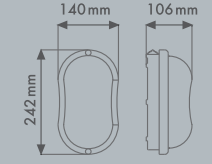

Ambalaj Şekli / Package Type	Kutu / Pack	Ağırlık / Weight	4.69 kg
Adet / m / Quantity / m	12	m ³ / Volume	0.043

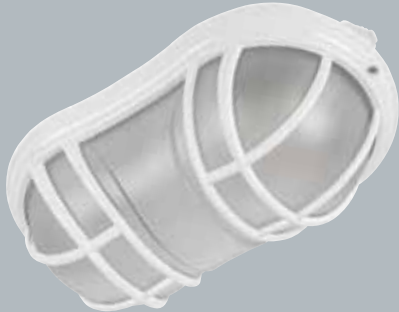

BEGONYA

Nemliyer Waterproff

Tavan ve Duvar Armatürü (Klasik)
Ceiling & Wall Lighting Fixture (Classic)

Ürün Kodu / Product Code
001 038 150101 00 00



CLASS II IP54



E27 MAX. 1x60W - 230 V ~ 50 Hz

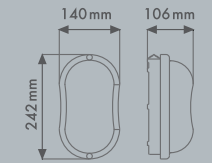

Ambalaj Şekli / Package Type	Kutu / Pack	Ağırlık / Weight	4.67 kg
Adet / m / Quantity / m	12	m ³ / Volume	0.043

**FULYA**Aplik
Wall Lamp

Ürün Kodu / Product Code
001 038 020201 00 00



CLASS I IP20

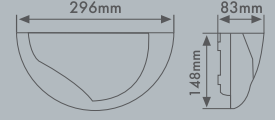

E27 MAX. 1x60W - 230 V ~ 50 Hz

Ambalaj Şekli / Package Type	Kutu / Pack	Ağırlık / Weight	3.06 kg
Adet / m / Quantity / m	10	m ³ / Volume	0.048

**MANOLYA**Aplik
Wall Lamp

Ürün Kodu / Product Code
001 038 010201 00 00



CLASS I IP20

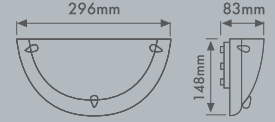

E27 MAX. 1x60W - 230 V ~ 50 Hz

Ambalaj Şekli / Package Type	Kutu / Pack	Ağırlık / Weight	2.61 kg
Adet / m / Quantity / m	10	m ³ / Volume	0.048

**YASEMİN**Aplik
Wall Lamp

Ürün Kodu / Product Code
001 038 090101 00 00



CLASS I IP20

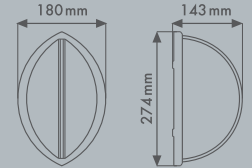

E27 MAX. 1x60W - 230 V ~ 50 Hz

Ambalaj Şekli / Package Type	Kutu / Pack	Ağırlık / Weight	3.63 kg
Adet / m / Quantity / m	8	m ³ / Volume	0.056

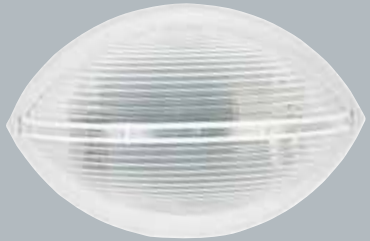
**YASEMİN**Oval Tavan Armatürü
Oval Lighting Fixture

Ürün Kodu / Product Code
001 038 080101 00 00



CLASS I IP20

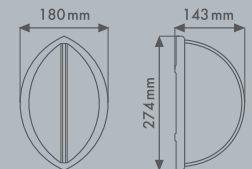

E27 MAX. 1x60W - 230 V ~ 50 Hz

Ambalaj Şekli / Package Type	Kutu / Pack	Ağırlık / Weight	3.39 kg
Adet / m / Quantity / m	8	m ³ / Volume	0.056



PİRAMİT

Aplik
Wall Lamp

Ürün Kodu / Product Code
001 038 190201 00 00



CLASS I IP20

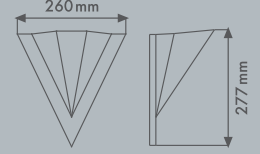

E27 MAX. 1x60W - 230 V ~ 50 Hz

Ambalaj Şekli / Package Type	Kutu / Pack	Ağırlık / Weight	4.35 kg
Adet / m / Quantity / m	8	m ³ / Volume	0.082



YELPAZE

Duvar Aplik
Queen Wall Lamp

Ürün Kodu / Product Code
016 038 250038

E27 MAX. 1x60W - 230 V ~ 50 Hz IP20

Ambalaj Şekli / Package Type Kutu / Pack

Adet / m / Quantity / m 48

Ağırlık / Weight 13.74 kg

m³ / Volume 0.093

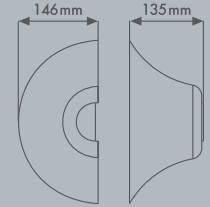

KRALIÇE

Duvar Aplik
Queen Wall Lamp

Ürün Kodu / Product Code
016 038 250013

E27 MAX. 1x60W - 230 V ~ 50 Hz IP20

Ambalaj Şekli / Package Type Kutu / Pack

Adet / m / Quantity / m 48

Ağırlık / Weight 17.52 kg

m³ / Volume 0.139

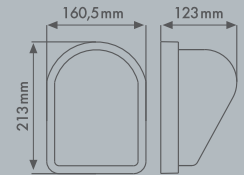

HİLAL

Duvar Aplik
Queen Wall Lamp

Ürün Kodu / Product Code
016 038 250037

E27 MAX. 1x60W - 230 V ~ 50 Hz IP20

Ambalaj Şekli / Package Type Kutu / Pack

Adet / m / Quantity / m 48

Ağırlık / Weight 12.48 kg

m³ / Volume 0.139

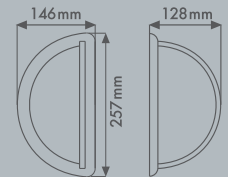



MANOLYA

Tavan Armatürü
Ceiling Lighting Fixture

Ürün Kodu / Product Code
001 038 010101 00 00



CLASS II IP20



E27 MAX. 1x75W - 230 V ~ 50 Hz

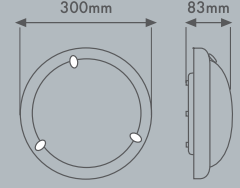

Ambalaj Şekli / Package Type	Kutu / Pack	Ağırlık / Weight	2.69 kg
Adet / m / Quantity / m	5	m ³ / Volume	0.048



FULYA

Tavan Armatürü
Ceiling Lighting Fixture

Ürün Kodu / Product Code
001 038 020101 00 00



CLASS II IP20



E27 MAX. 1x75W - 230 V ~ 50 Hz

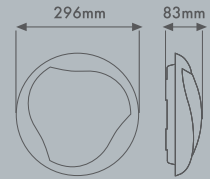

Ambalaj Şekli / Package Type	Kutu / Pack	Ağırlık / Weight	2.71 kg
Adet / m / Quantity / m	5	m ³ / Volume	0.048



AKASYA

Tavan Armatürü
Ceiling Lighting Fixture

Ürün Kodu / Product Code
001 038 180101 00 00



CLASS II IP20



E27 MAX. 1x60W - 230 V ~ 50 Hz

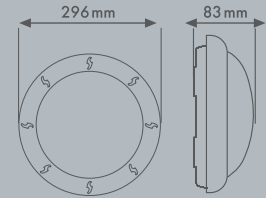

Ambalaj Şekli / Package Type	Kutu / Pack	Ağırlık / Weight	2.70 kg
Adet / m / Quantity / m	8	m ³ / Volume	0.044

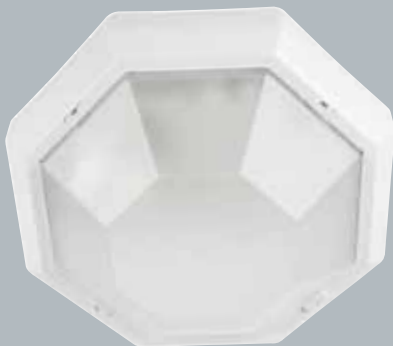

KAMELYA

Tavan Armatürü
Ceiling Lighting Fixture

Ürün Kodu / Product Code
001 038 170101 00 00



CLASS II IP54



E27 MAX. 1x60W - 230 V ~ 50 Hz

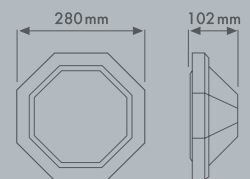

Ambalaj Şekli / Package Type	Kutu / Pack	Ağırlık / Weight	2.60 kg
Adet / m / Quantity / m	5	m ³ / Volume	0.042

**MERVE**Tavan Armatürü
Ceiling Lighting FixtureÜrün Kodu / Product Code
001 038 110101 00 00

CLASS II IP20

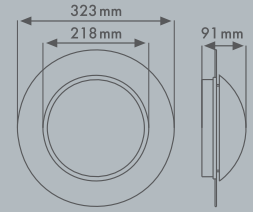

E27 MAX. 1x60W - 230 V ~ 50 Hz

Ambalaj Şekli / Package Type	Kutu / Pack	Ağırlık / Weight	2.30 kg
Adet / m / Quantity / m	5	m ³ / Volume	0.047

**SADE**Hazır Askı Tij Takımı
Lamp Holder and Hanging SetÜrün Kodu / Product Code
001 038 250018 00 00

E27

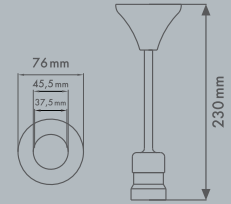

Ambalaj Şekli / Package Type	Kutu / Pack
Adet / m / Quantity / m	500
Ağırlık / Weight	37.62 kg
m ³ / Volume	0.131

**PAPATYA**Askı Tij Takımı
Lamp Holder and Hanging SetÜrün Kodu / Product Code
024 038 250016

E27

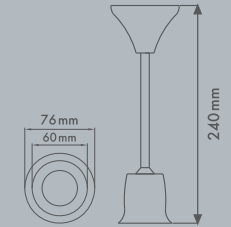

Ambalaj Şekli / Package Type	Kutu / Pack
Adet / m / Quantity / m	250
Ağırlık / Weight	24.25 kg
m ³ / Volume	0.131

**PAPATYA**Büyük Askı Tij Takımı
Lamp Holder and Hanging Set BigÜrün Kodu / Product Code
024 038 250017

E27

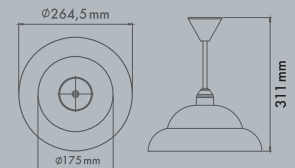

Ambalaj Şekli / Package Type	Kutu / Pack
Adet / m / Quantity / m	80
Ağırlık / Weight	11.20 kg
m ³ / Volume	0.131



SİMİT

Armatür (Elektronik Balanstlı)
Lighting Fixture (Electronic Ballast)

Ürün Kodu / Product Code
016 038 250025

32W - 230 V ~ 50 Hz IP20

Ambalaj Şekli / Package Type Kutu / Pack

Adet / m / Quantity / m 20

Ağırlık / Weight 17.2 kg

m³ / Volume 0.227

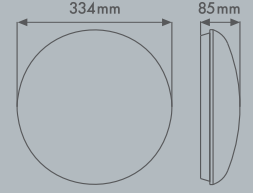

METALİZE

Çift Duylu Metalize Armatür
Double Lampholder Metallize Lighting Fixture

Ürün Kodu / Product Code
016 038 250047

2x40 W 230 V ~ 50 Hz IP20

Ambalaj Şekli / Package Type Kutu / Pack

Adet / m / Quantity / m 20

Ağırlık / Weight 17.2 kg

m³ / Volume 0.227

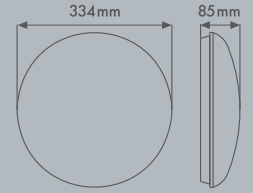

SARKIT

Polikarbonat Duylu Armatür
Pendant Lighting Lampholder With Polycarbonate

Ürün Kodu / Product Code
024 038 250019

E27

Ambalaj Şekli / Package Type Kutu / Pack

Adet / m / Quantity / m 35

Ağırlık / Weight 12.39 kg

m³ / Volume 0.118

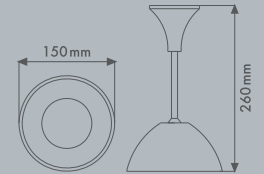

Renk Seçenekleri Color Options





AQUA

Nemliyer Waterproof

Kafesli Aplik Armatür Beyaz
Wall Fixture Antigron White

Ürün Kodu / Product Code
016 038 411100

CLASS II

IP 54

MAX. 26 W

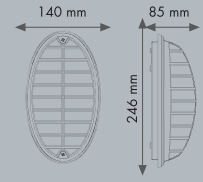

Ambalaj Şekli / Package Type	Kutu / Pack	Ağırlık / Weight	6.27 kg.
Adet / m / Quantity / m	20	m ³ / Volume	0.066



AQUA

Nemliyer Waterproof

Kafesli Aplik Armatür Siyah
Wall Fixture Antigron Black

Ürün Kodu / Product Code
016 038 411111

CLASS II

IP 54

MAX. 26 W

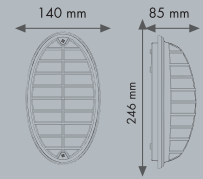

Ambalaj Şekli / Package Type	Kutu / Pack	Ağırlık / Weight	6.27 kg.
Adet / m / Quantity / m	20	m ³ / Volume	0.066



OPAK

Kafesli Armatür Beyaz
Fixture Antigron White

Ürün Kodu / Product Code
016 038 411300

CLASS II

IP 54

MAX. 26 W

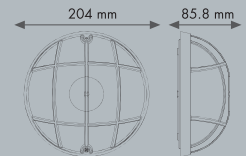

Ambalaj Şekli / Package Type	Kutu / Pack	Ağırlık / Weight	6.48 kg.
Adet / m / Quantity / m	24	m ³ / Volume	0.091



OPAK

Kafesli Armatür Siyah
Fixture Antigron Black

Ürün Kodu / Product Code
016 038 411311

CLASS II

IP 54

MAX. 26 W

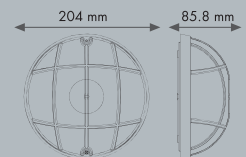

Ambalaj Şekli / Package Type	Kutu / Pack	Ağırlık / Weight	6.48 kg.
Adet / m / Quantity / m	24	m ³ / Volume	0.091

**ELİPS**Opal Armatür Beyaz
Opal Lighting Fixture WhiteÜrün Kodu / Product Code
016 038 410600

CLASS II

IP 65

MAX. 26 W

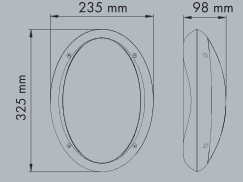

Ambalaj Şekli / Package Type	Kutu / Pack	Ağırlık / Weight	9.54 kg.
Adet / m / Quantity / m	10	m ³ / Volume	0.082

**ELİPS**Opal Armatür Siyah
Opal Lighting Fixture BlackÜrün Kodu / Product Code
016 038 410611

CLASS II

IP 65

MAX. 26 W

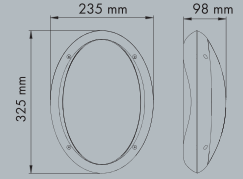

Ambalaj Şekli / Package Type	Kutu / Pack	Ağırlık / Weight	9.54 kg.
Adet / m / Quantity / m	10	m ³ / Volume	0.082

**OPAL**Armatür Beyaz
Lighting Fixture WhiteÜrün Kodu / Product Code
016 038 410500

CLASS II

IP 65

MAX. 26 W

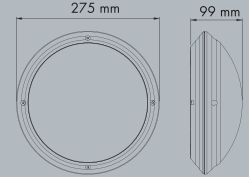

Ambalaj Şekli / Package Type	Kutu / Pack	Ağırlık / Weight	7.57 kg.
Adet / m / Quantity / m	10	m ³ / Volume	0.081

**OPAL**Armatür Siyah
Lighting Fixture BlackÜrün Kodu / Product Code
016 038 410511

CLASS II

IP 65

MAX. 26 W

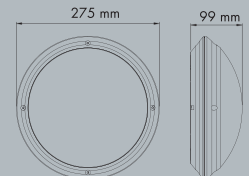

Ambalaj Şekli / Package Type	Kutu / Pack	Ağırlık / Weight	7.57 kg.
Adet / m / Quantity / m	10	m ³ / Volume	0.081

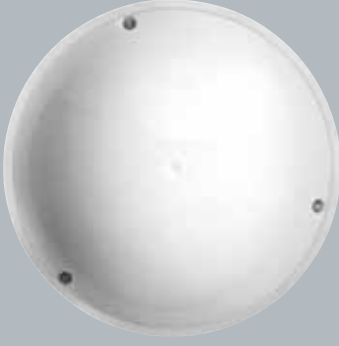
**DOLUNAY**Opak Armatür Beyaz
Opak Lighting Fixture WhiteÜrün Kodu / Product Code
016 038 700100

CLASS II

IP 54

MAX. 26 W

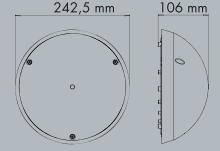

Ambalaj Şekli / Package Type	Kutu / Pack	Ağırlık / Weight	7.57 kg.
Adet / m / Quantity / m	10	m ³ / Volume	0.081

**DOLUNAY**Opak Armatür Siyah
Opak Lighting Fixture BlackÜrün Kodu / Product Code
016 038 700100

CLASS II

IP 54

MAX. 26 W

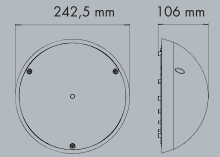

Ambalaj Şekli / Package Type	Kutu / Pack	Ağırlık / Weight	7.57 kg.
Adet / m / Quantity / m	10	m ³ / Volume	0.081

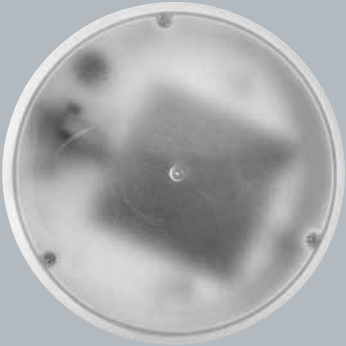
**DOLUNAY**Şeffaf Armatür Beyaz
Transparant Lighting Fixture WhiteÜrün Kodu / Product Code
016 038 700200

CLASS II

IP 54

MAX. 26 W

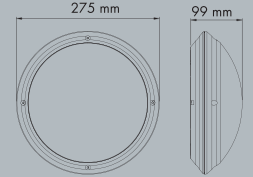

Ambalaj Şekli / Package Type	Kutu / Pack	Ağırlık / Weight	7.57 kg.
Adet / m / Quantity / m	10	m ³ / Volume	0.081

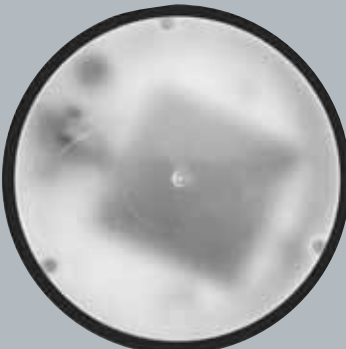
**DOLUNAY**Şeffaf Armatür Siyah
Transparant Lighting Fixture BlackÜrün Kodu / Product Code
016 038 700211

CLASS II

IP 54

MAX. 26 W

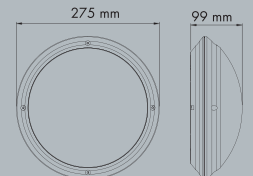

Ambalaj Şekli / Package Type	Kutu / Pack	Ağırlık / Weight	7.57 kg.
Adet / m / Quantity / m	10	m ³ / Volume	0.081

**DOLUNAY**Opak Aplik Beyaz
Opak Wall Lamp WhiteÜrün Kodu / Product Code
016 038 700300

MAX. 26 W

IP 54

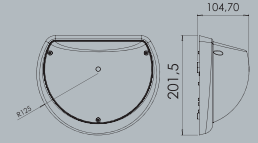

Ambalaj Şekli / Package Type	Kutu / Pack	Ağırlık / Weight	15.14kg.
Adet / m / Quantity / m	20	m ³ / Volume	0.162

**DOLUNAY**Opak Aplik Siyah
Opak Wall Lamp BlackÜrün Kodu / Product Code
016 038 700311

MAX. 26 W

IP 54

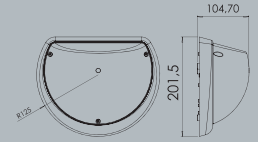

Ambalaj Şekli / Package Type	Kutu / Pack	Ağırlık / Weight	15.14kg.
Adet / m / Quantity / m	20	m ³ / Volume	0.162

**DOLUNAY**Şeffaf Armatür Beyaz
Transparant Lighting Fixture WhiteÜrün Kodu / Product Code
016 038 700400

MAX. 26 W

IP 54

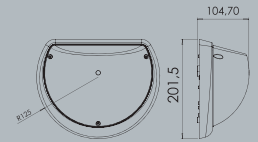

Ambalaj Şekli / Package Type	Kutu / Pack	Ağırlık / Weight	15.14kg.
Adet / m / Quantity / m	20	m ³ / Volume	0.162

**DOLUNAY**Şeffaf Armatür Siyah
Transparant Lighting Fixture BlackÜrün Kodu / Product Code
016 038 700411

MAX. 26 W

IP 54

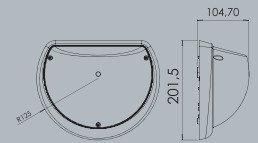

Ambalaj Şekli / Package Type	Kutu / Pack	Ağırlık / Weight	15.14kg.
Adet / m / Quantity / m	20	m ³ / Volume	0.162

**OPAK**Armatür Beyaz
Lighting Fixture WhiteÜrün Kodu / Product Code
016 038 410800

MAX. 26 W

IP 54

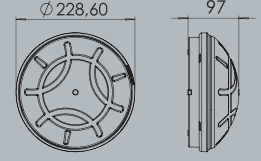

Ambalaj Şekli / Package Type	Kutu / Pack	Ağırlık / Weight	4.86 kg.
Adet / m / Quantity / m	16	m ³ / Volume	0.069

**OPAK**Armatür Siyah
Lighting Fixture BlackÜrün Kodu / Product Code
016 038 410811

MAX. 26 W

IP 54

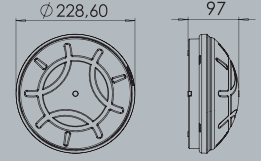

Ambalaj Şekli / Package Type	Kutu / Pack	Ağırlık / Weight	4.86 kg.
Adet / m / Quantity / m	16	m ³ / Volume	0.069

**ALÜMİNYUM**
Nemliyer WaterproffKafesli Cam Armatür Beyaz
Glass Fixture Antigron WhiteÜrün Kodu / Product Code
016 038 700500

MAX. 26 W

IP 54

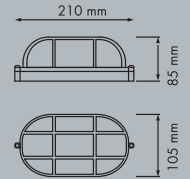

Ambalaj Şekli / Package Type	Kutu / Pack	Ağırlık / Weight	3 kg.
Adet / m / Quantity / m	20	m ³ / Volume	0.080

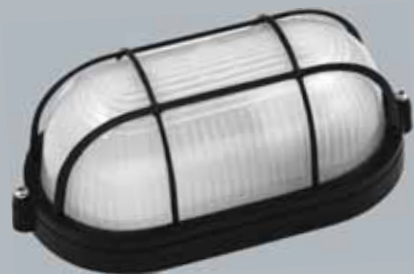
**ALÜMİNYUM**
Nemliyer WaterproffKafesli Cam Armatürü Siyah
Glass Fixture Antigron BlackÜrün Kodu / Product Code
016 038 700511

MAX. 26 W

IP 54

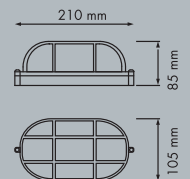

Ambalaj Şekli / Package Type	Kutu / Pack	Ağırlık / Weight	3 kg.
Adet / m / Quantity / m	20	m ³ / Volume	0.080

**RADARLED**Radar Sensörlü Tavan Armatür
Radar Sensor Globe Lighting FixtureÜrün Kodu / Product Code
016 038 250081Lumen 900 Renk 6500K
Lumen 900 Color 6500K IP 20

Ambalaj Şekli / Package Type	Kutu / Pack	Ağırlık / Weight	1.2 kg.
Adet / m / Quantity / m	20	m ³ / Volume	0.146

**RADARLED**Radar Sensörlü Tavan Armatür
Radar Sensor Globe Lighting FixtureÜrün Kodu / Product Code
016 038 250082Lumen 900 Renk 6500K
Lumen 900 Color 6500K IP 20

Ambalaj Şekli / Package Type	Kutu / Pack	Ağırlık / Weight	1.2 kg.
Adet / m / Quantity / m	20	m ³ / Volume	0.146

**RADARLED**Radar Sensörlü Tavan Armatür
Radar Sensor Globe Lighting FixtureÜrün Kodu / Product Code
016 038 250083Lumen 900 Renk 6500K
Lumen 900 Color 6500K IP 20

Ambalaj Şekli / Package Type	Kutu / Pack	Ağırlık / Weight	1.2 kg.
Adet / m / Quantity / m	20	m ³ / Volume	0.146

**RADARLED**Radar Sensörlü Tavan Armatür
Radar Sensor Globe Lighting FixtureÜrün Kodu / Product Code
016 038 250084Lumen 900 Renk 6500K
Lumen 900 Color 6500K IP 20

Ambalaj Şekli / Package Type	Kutu / Pack	Ağırlık / Weight	1.2 kg.
Adet / m / Quantity / m	20	m ³ / Volume	0.146

**LED**Tavan Armatür
Lighting Fixture

Ürün Kodu / Product Code
016 038 250071

Lumen 900 Renk 6500K
Lumen 900 Color 6500K

IP 20

Ambalaj Şekli / Package Type	Kutu / Pack	Ağırlık / Weight	1.2 kg.
Adet / m / Quantity / m	20	m ³ / Volume	0.146

**LED**Tavan Armatür
Lighting Fixture

Ürün Kodu / Product Code
016 038 250072

Lumen 900 Renk 6500K
Lumen 900 Color 6500K

IP 20

Ambalaj Şekli / Package Type	Kutu / Pack	Ağırlık / Weight	1.2 kg.
Adet / m / Quantity / m	20	m ³ / Volume	0.146

**LED**Tavan Armatür
Lighting Fixture

Ürün Kodu / Product Code
016 038 250073

Lumen 900 Renk 6500K
Lumen 900 Color 6500K

IP 20

Ambalaj Şekli / Package Type	Kutu / Pack	Ağırlık / Weight	1.2 kg.
Adet / m / Quantity / m	20	m ³ / Volume	0.146

**LED**Tavan Armatür
Lighting Fixture

Ürün Kodu / Product Code
016 038 250074

Lumen 900 Renk 6500K
Lumen 900 Color 6500K

IP 20

Ambalaj Şekli / Package Type	Kutu / Pack	Ağırlık / Weight	1.2 kg.
Adet / m / Quantity / m	20	m ³ / Volume	0.146

**360°****Hareket Sensörlü Glob Armatür**
Sensor Globe Lighting Fixture

Ürün Kodu / Product Code
001 038 250022 00 00

E27 MAX. 2x25W - 230 V ~ 50 Hz IP20

Ambalaj Şekli / Package Type Kutu / Pack

Adet / m / Quantity / m 10

Ağırlık / Weight 14.46

m³ / Volume 0.124

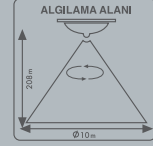
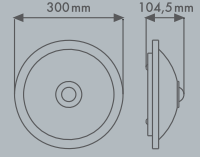
**80 LED****Ledli Sensörlü Tavan Armatürü**
Led Sensor Ceiling Fixture

Ürün Kodu / Product Code
016 038 250044

80 Adet / 8 lm / 20 mA 120° LED
230 V ~ 50 Hz IP 20

Ambalaj Şekli / Package Type Kutu / Pack

Adet / m / Quantity / m 10

Ağırlık / Weight 13.76

m³ / Volume 0.124

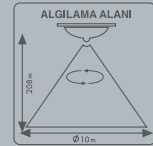
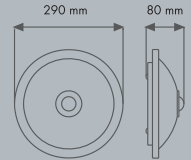
**80 KROMLED****Ledli Sensörlü Tavan Armatürü**
Led Chrome Sensor Ceiling Fixture

Ürün Kodu / Product Code
016 038 600080

80 Adet / 8 lm / 20 mA 120° LED
230 V ~ 50 Hz IP 20

Ambalaj Şekli / Package Type Kutu / Pack

Adet / m / Quantity / m 10

Ağırlık / Weight 13.76

m³ / Volume 0.124

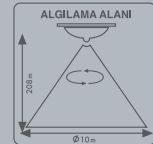
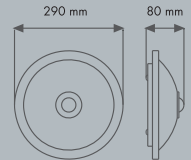



LEDSENSÖR

Led Sensörlü Glob Armatür
Sensor Led Lighting Fixture

Ürün Kodu / Product Code
016 038 250061

E27 MAX. 2x25W - 230 V ~ 50 Hz IP20

Ambalaj Şekli / Package Type Kutu / Pack

Adet / m / Quantity / m 10

Ağırlık / Weight 14.46

m³ / Volume 0.124

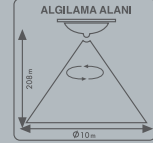
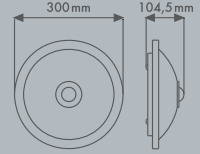

LEDSENSÖR

Led Sensörlü Glob Armatür - Kitli
Sensor Led Lighting Fixture - Kit

Ürün Kodu / Product Code
016 038 250060

E27 MAX. 2x25W - 230 V ~ 50 Hz IP20

Ambalaj Şekli / Package Type Kutu / Pack

Adet / m / Quantity / m 10

Ağırlık / Weight 14.46

m³ / Volume 0.124

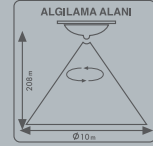
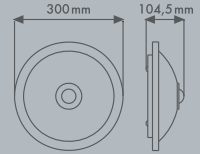

LEDSENSÖR

Duvar Aplik
Queen Wall Lamp

Ürün Kodu / Product Code
078 039 500110

E27 MAX. 2x25W - 230 V ~ 50 Hz IP20

Ambalaj Şekli / Package Type Kutu / Pack

Adet / m / Quantity / m 20

Ağırlık / Weight 10.40 kg

m³ / Volume 0.092



SENSÖR

E27 Duyulu Duvar Aplik
E27 Lamp Holder Wall Lamp

Ürün Kodu / Product Code
078 039 500100

E27 MAX. 2x25W - 230 V ~ 50 Hz IP20

Ambalaj Şekli / Package Type Kutu / Pack

Adet / m / Quantity / m 20

Ağırlık / Weight 10.40 kg

m³ / Volume 0.092

**DEKORATİF**Cam Armatür Beyaz
Glass Fixture WhiteÜrün Kodu / Product Code
079 039 140003

MAX. 2x60 W

IP 20

Ambalaj Şekli / Package Type	Kutu / Pack
Adet / m / Quantity / m	12
Ağırlık / Weight	14.46
m ³ / Volume	0.124

**DEKORATİF**Cam Armatür Krom Beyaz
Glass Fixture Chrome WhiteÜrün Kodu / Product Code
079 039 140002

MAX. 2x60 W

IP 20

Ambalaj Şekli / Package Type	Kutu / Pack
Adet / m / Quantity / m	12
Ağırlık / Weight	14.46
m ³ / Volume	0.124

**GÜNEŞ**Cam Armatür
Glass FixtureÜrün Kodu / Product Code
079 039 140005

MAX. 2x60 W

Ambalaj Şekli / Package Type	Kutu / Pack
Adet / m / Quantity / m	12
Ağırlık / Weight	14.46
m ³ / Volume	0.124

**GÜNEŞ**Yarım Ay Cam Aplik
Half Moon Glass Wall LampÜrün Kodu / Product Code
079 039 140001

MAX. 2x60 W

Ambalaj Şekli / Package Type	Kutu / Pack
Adet / m / Quantity / m	20
Ağırlık / Weight	14.46
m ³ / Volume	0.124

**CAM ARMATÜR**Cam Armatür Çift Duylu
Glass Fixture Lamp HolderÜrün Kodu / Product Code
078 039 130002

MAX. 2x60 W

IP 20

Ambalaj Şekli / Package Type	Kutu / Pack
Adet / m / Quantity / m	12
Ağırlık / Weight	14.46
m ³ / Volume	0.124

**CAM ARMATÜR**Cam Armatür Krom Çift Duylu
Glass Fixture Chrome Lamp HolderÜrün Kodu / Product Code
078 039 130001

MAX. 2x60 W

IP 20

Ambalaj Şekli / Package Type	Kutu / Pack
Adet / m / Quantity / m	12
Ağırlık / Weight	14.46
m ³ / Volume	0.124

**MARTI**Cam Armatür
Glass FixtureÜrün Kodu / Product Code
078 039 130130

MAX. 2x60 W

Ambalaj Şekli / Package Type	Kutu / Pack
Adet / m / Quantity / m	12
Ağırlık / Weight	14.46
m ³ / Volume	0.124

**MARTI**Yarım Ay Cam Aplik
Half Moon Glass Wall LampÜrün Kodu / Product Code
078 039 130200

MAX. 2x60 W

Ambalaj Şekli / Package Type	Kutu / Pack
Adet / m / Quantity / m	20
Ağırlık / Weight	14.46
m ³ / Volume	0.124



ACİLLED

Sıvaüstü Acil Aydınlatma Armatürü
Surface Mounted Emergency Lighting

Ürün Kodu / Product Code

112 039 011717 17 LED

112 039 013434 34 LED

112 039 015151 51 LED

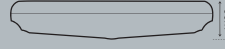

ACİLLED

Sıvaaltı Acil Aydınlatma Armatürü
Recessed Mounted Emergency Lighting

Ürün Kodu / Product Code

112 039 121717 17 LED

112 039 123434 34 LED

112 039 125151 51 LED

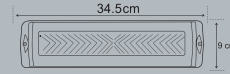
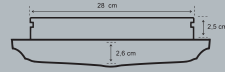

SEYYAR AYDINLATMA



7 W LED 5'li İç Mekan Aydınlatma Seti
7 W LED Interior Lighting Set (5 pcs)

Ürün Kodu / Product Code

010 093 100700

SEYYAR AYDINLATMA



9 W LED 5'li Dış Mekan Aydınlatma Seti
9 W LED Outdoor Lighting Set (5 pcs)

Ürün Kodu / Product Code

010 093 100900

IP 67

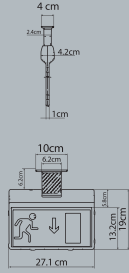

LED ACİL DURUM

Cift Yüzlü Yön Tavan Serisi
Acil Durum Armatürü
Double Sided For Ceiling
Emergency Lighting

Ürün Kodu / Product Code
112 038 1000 - XX

- Dekoratif ABS gövde
- Acilde veya sürekli çalışma
- 1 veya 3 saat yanma süresi
- NI-CD Uzun ömürlü batarya
- Pleksiglas üzeri gravür veya UV uygulama
- Aşırı şarj ve deşarja karşı koruma
- Şarj olma süresi 24 saat

- Decorative ABS Body
- Runs continuously or in Emergency
- Lighting duration of 1 or 3 hours
- NI-CD long life battery
- Engraving on Plexiglass
- Different colour options in bulk orders
- Ultra-bright LEDs

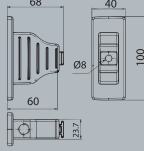

LED ACİL DURUM

Cift Yüzlü Yön Duvar Serisi
Acil Durum Armatürü
Double Sided For Wall Ceiling
Emergency Lighting

Ürün Kodu / Product Code
112 038 2000 - XX

- Dekoratif ABS gövde
- Acilde veya sürekli çalışma
- 1 veya 3 saat yanma süresi
- NI-CD Uzun ömürlü batarya
- Pleksiglas üzeri gravür veya UV uygulama
- Aşırı şarj ve deşarja karşı koruma
- Şarj olma süresi 24 saat

- Decorative ABS Body
- Runs continuously or in Emergency
- Lighting duration of 1 or 3 hours
- NI-CD long life battery
- Engraving on Plexiglass
- Different colour options in bulk orders
- Ultra-bright LEDs

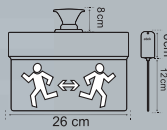

LED ACİL DURUM

Cift Yüzlü (Alüminyum) İşaret Serisi
Acil Durum Armatürü
Double Sided Aluminium
Sing - Emergency Lighting

Ürün Kodu / Product Code
112 038 3000 - XX

- Dekoratif alüminyum eloksal gövde
- Acilde veya sürekli çalışma
- 1 veya 3 saat yanma süresi
- NI-CD Uzun ömürlü batarya
- Pleksiglas üzeri gravür uygulama
- Ultra parlak ledler
- Aşırı şarj ve deşarja karşı koruma
- Şarj olma süresi 24 saat

- Decorative Aluminium Anodised Body
- Option for Lighting continuously or in emergency
- Lighting duration of 1 or 3 hours
- NI-CD long life battery
- Engraving on Plexiglass
- Ultra-Bright LEDs
- Protection against over-charge and discharge
- 24 Hour Charging time



LED ACİL DURUM

Bilgi Serisi
Acil Durum Armatürü
Bilgi Series
Info - Emergency Lighting

Ürün Kodu / Product Code
112 038 4000 - XX

- Acilde 1 veya 3 saat yanma süresi
- NI-CD Uzun ömürlü batarya
- Acilde veya sürekli çalışma
- Akrilik üzeri folyo uygulama
- Şarj olma süresi 24 saat

- Lighting duration of 1 or 3 hours
- NI-CD long life battery
- Option for Lighting continuously or in emergency
- Foil printing on acrylic board
- 24 Hour Charging time